

# **Opportunities for Low Cost Titanium in Reduced Fuel Consumption, Improved Emissions, and Enhanced Durability Heavy-Duty Vehicles**

**A Study Performed For  
US Department of Energy  
And  
Oak Ridge National Laboratory  
Subcontract 4000013062**

**By:**

**EHKTechnologies  
10917 S.E. Burlington Dr.  
Vancouver, WA 98664  
Phone: 360-896-0031  
Fax: 360-896-0032  
[www.ehktechnologies.com](http://www.ehktechnologies.com)**

**Date Published: July 2002**

Research sponsored by the U.S. Department of Energy, Assistant Secretary for Energy Efficiency and Renewable Energy, Office of the FreedomCAR and Vehicle Technology Program, as part of the Heavy Vehicle Propulsion Materials Program, under contract DE-AC05-00OR22725 with UT-Battelle, LLC.

# Contents

<u>Section</u>	<u>Page</u>
List of Figures	v
List of Tables	vi
1.0 Summary of Findings	1
2.0 Introduction	7
3.0 The Heavy-Duty Vehicle Market	9
4.0 Heavy-Duty Vehicle Systems	12
4.1 Material Selection Drivers	12
4.1.1 Material Selection Drivers	12
4.1.2 Vehicle Weight	13
4.1.3 Unique Material Properties	14
4.2 Vehicle Systems – Body	14
4.2.1 Cab Shell and Interior	14
4.2.2 Container Bodies	14
4.3 Vehicle Systems – Chassis	17
4.4 Vehicle Systems – Suspension	17
4.5 Vehicle Systems – Engine	18
4.5.1 Turbocharger Components	19
4.5.2 Valves	21
4.5.3 Other Valve Train	22
4.5.4 Power Cycle Parts	22
4.6 Vehicle Systems – Air Intake and Exhaust	23
4.6.1 Air Intake	23
4.6.2 Exhaust System	23
4.7 Vehicle Systems – Drive Train	24
4.7.1 Drive Shafts, Axles...	24
4.7.2 Brakes...	25
5.0 Titanium Raw Material Production Processes	26
5.1 Titanium Bearing Minerals	26
5.2 Energetics of Titania Reduction	27
5.3 Conventional Titania Reduction Processes	27
5.4 Titanium Sponge	28
5.5 Titanium Scrap Usage	31
5.6 New Titanium Production Processes	31
5.6.1 FFC-Cambridge Process	32
5.6.2 International Titanium Powder (Armstrong) Process	34
5.6.3 Ginatta Process	35
5.6.4 Plasma Quench Technologies Process	36
5.6.5 MIT Electrolytic Reduction	38
5.6.6 Boston U. Solid Oxide Membrane Process	38
6.0 Titanium Component Production Processes	39
6.1 Casting Technology	39
6.2 Powder Metallurgy	39

6.2.1	Ti Hydride – Dehydride Process	40
6.2.2	Dynamet Technologies Particulate Reinforced Composites	41
6.2.3	Powder Cold Spray; Sandia National Laboratory	42
6.2.4	Cold Compacted Mill Forms; DuPont Powder Metallurgy	43
6.3	Automotive Applications	43
6.3.1	TIMET Automotive	44
6.4	Other Governmental Efforts	45
6.4.1	U.S. Department of Defense	45
6.4.2	Australian CSIRO	45
7.0	References	46
8.0	Acknowledgements	47

## List of Figures

<u>Figure</u>		<u>Page</u>
1	North American Truck Factory Sales History and Forecast	10
2	Diesel and Gasoline Engines Used in Trucks and Buses in 2001	11
3	Heavy-Duty Truck Suspension	17
4	Heavy-Duty Truck Leaf Springs	17
5	Hysteresis in Multiple Leaf Springs	18
6	Schematic Diagram of Turbocharger Rotor Investment Casting	20
7	Free Energy of Formation of Oxides	27
8	Variation in Titanium Sponge Production	30
9	Variation in Titanium Sponge Price	30
10	Production and Price History for Magnesium	31
11	Production and Price History for Aluminum	31
12	Annual US Ti Scrap and Sponge Consumption and Scrap Price	32
13	Schematic Description of the FFC-Cambridge Process	33
14	Schematic Description of the FFC-Cambridge Process Reduction Step	33
15	Schematic Description of the ITP Process	37
16	The Hydride-Dehydride Process	40
17	Components Made By Hydride-Dehydride Process	41
18	The Dynamet CermeTi <sup>®</sup> Process	42
19	Parts Made With CermeTi <sup>®</sup> Composite	42
20	Cold Spray Process	43
21	Illustration of Copper Deposition	43
22	Candidate Ti Applications Identified by TIMET Automotive Division	45

## List of Tables

<u>Table</u>	<u>Page</u>	
1	Summary of Heavy Vehicle Components with High to Moderate Probability of Titanium Substitution	3
2	Summary of Heavy Vehicle Components with Moderate to Low Probability of Titanium Substitution	4
3	Summary of Developing TiO <sub>2</sub> Reduction Technologies	5
4	Summary of Developing Ti Component Production Technologies	6
5	Eight Weight Classifications and Four Engine Classifications of North American Trucks	9
6	Year 2001 Truck and Bus Manufacturer Market Shares	10
7	Market Shares of Heavy-Duty Diesel Engines in 2001	11
8	EPA Definitions of "Useful Life"	12
9	2004 Heavy Diesel Emission Certification Options	13
10	Comparison of Current Materials with Titanium Alternatives for Components of Heavy-Duty Vehicles	15
11	Sources, Impurities and Prices for Titania	26
12	Purity and Recent Average Price for Available Titanium Sponge	29
13	Current and Recent Automotive Applications of Titanium Materials	44

## **1.0 Summary of Findings**

The purpose of this study was to determine which components of heavy-duty highway vehicles are candidates for the substitution of titanium materials for current materials if the cost of those Ti components is very significantly reduced from current levels. The processes which could be used to produce those low cost components were also investigated.

Heavy-duty highway vehicles are defined as all trucks and busses included in Classes 2C through 8. These include heavy pickups and vans above 8,500 lbs. GVWR, through highway tractor trailers. Class 8 is characterized as being a very cyclic market, with “normal” year volume, such as in 2000, of approximately 240,000 new vehicles. Classes 3 – 7 are less cyclic, with “normal;” i.e., year 2000, volume totaling approximately 325,000 new vehicles. Classes 3 – 8 are powered about 88.5% by diesel engines, and Class 2C at very roughly 83% diesel. The engine portion of the study therefore focused on diesels. Vehicle production volumes were used in estimates of the market size for candidate components.

Opportunities for titanium materials were found to be driven by one of three issues:

- **Emissions Reduction:** Reduced emissions were not found to be a sufficient driver to justify any premium cost for overall vehicle weight reduction. Attempts to meet 2004 emission regulations, being implemented in Oct. 2002, have resulted in higher diesel engine cylinder pressure and temperature and improved engine control. These changes have provided some opportunity for Ti.
- **Vehicle Weight:** Vehicle weight was found to be an important issue for only the bulk haul market segment, which normally operates at maximum weight. This segment is willing to pay a small premium of \$3 – 4 per pound of saved weight to allow additional payload. Unfortunately, this is only about 5 to 7% of the Class 8 market, which in most cases will not be sufficient to attract the investment needed to develop and produce specialty components.
- **Unique Material Properties:** The combination of lower density than steel and superalloys, higher temperature capability than aluminum and lower stiffness than steel have provided opportunity.

Table 1 summarizes the opportunities found for titanium material components which are judged to have a moderate to high probability of titanium substitution. Components were considered to have this adoption probability if they are either being implemented, or have a significant level of interest by the industry, and cost reduction through process development is judged to have a reasonable chance of success. For each component, the market size is estimated to provide an indication of the commercial incentive manufacturers would have to perform the necessary innovation. The material candidates, current status and drivers and impediments are listed. Options for required process development are included based on discussion with users and component manufacturers. Table 2 summarizes the opportunities which are judged to have only moderate to low probability of Ti substitution. Note that exhaust systems are on this list,

even though Ti is being used in the Chevy Corvette. This application is actually judged to have significant potential if the cost of Ti sheet can be greatly reduced.

In order for Ti materials to substitute for current steel and aluminum alloys in any of the applications listed in these tables, very large cost reductions in raw Ti and component manufacture must take place. Current titanium material and component suppliers have expressed skepticism about TiO<sub>2</sub> reduction cost breakthroughs. Many of these companies are, however, pursuing their own proprietary approaches to cost reduction in component manufacture. In fact, several promising approaches are being pursued for TiO<sub>2</sub> reduction, and innovative component production process routes are being developed. These may lead to new alloy compositions. Table 3 lists several TiO<sub>2</sub> reduction processes, and Table 4 lists component production processes. Others may also be in development which were not found during this study, so that omission or inclusion in this list does not indicate any endorsement or judgment on viability.

Because of the properties which make Ti attractive in some highway heavy vehicle applications, these materials are also of interest to other communities. Certainly light highway vehicles have many of the same incentives for light weight, and probably have additional opportunities because of the high speed of small engines. The light vehicle group within DOE has, and is expected to continue, interest in promoting weight reduction and cost reduction for Ti. The U.S. military has identified new applications for 5 – 10,000 tons/year of titanium materials. In May 2002, DARPA issued a solicitation on cost reduction technology development. Australia has been a very important source of titanium bearing minerals. The CSIRO has a plan for the further development of their industry through creation of a Titanium Cooperative Research Center, with cost reduction and production goals for sponge and mill products.

Cost continues to be the key issue for expanded use of titanium materials. Ti bearing minerals are slightly more expensive than those for Al, and are close to costs for Mg sources. This does not account for the price premium for Ti over the other two light metals. The processing necessary to refine titanium raw materials and convert them to the metal is significantly more expensive than for Al or Mg. Because of this discrepancy, high volume applications have not developed which would serve as an incentive for cost reducing innovation. In addition, the volatility of the markets served by Ti, with resulting metal availability and price volatility, has further reduced incentive. In fact, the capacity for sponge production has declined significantly in the past decade, particularly when the former Soviet Union (FSU) is included. In addition, whereas it has been assumed by some that this FSU capacity would return and provide a low cost source of sponge, this does not appear to be the case. Much of the FSU capacity has been severely degraded and would take large capital investment to rebuild, resulting in prices not significantly lower than those of today's market. Target costs for various components in Ti range from equivalent to Al or stainless steel, up to \$3 – 6/lb. It is clear that innovations such as those discussed here are necessary in order for titanium materials to achieve significant penetration of the heavy-duty highway vehicle market.

Table 1. Summary of Heavy Vehicle Components with High to Moderate Probability of Titanium Substitution

<b>Component / Market Size</b>	<b>Material Candidates Status &amp; Adoption Drivers or Impediments</b>	<b>Process &amp; Development Options</b>
Turbocharger Compressor Rotor ~100K @ Current Cost ~640K w/ 50% Cost Reduction	Ti – 6 Al – 4 V; Being Adopted Due To LCF of Al in Higher Pressure/Temp. Engines + Emissions; Engine Design - Turbo Cost 2X; Higher Density Than Al	Casting: Change Investment Cast To High Volume Methods; Use Permanent Molds With Inserts. New method of melt production. Injection Molding; Machining
Engine Valves ~1.5-2M if Cost Reduced ~8M if All Use Camless Design	Ti – 6 Al – 4 V, TiAl, Composites. Under Development; Light Weight Essential With Camless Engine, Desired For Non-OHC & Some Others + Emissions; Engine Design - Ti Cost 3 – 5 X Standard	Casting: Hi Volume Investment or Permanent Mold Powder Met.: Wet Bag CIP Joining, Coating or cladding Machining &NDE
Leaf Springs No Potential at \$7/lb ~140K (6.7M lb) @ \$3.40/lb Total Potential ~2.5M (60K Ton)	No Development Done. Highest Tonnage Potential of All Applications + Performance (Low Modulus); Less Weight - Cost	Casting: Permanent Mold Continuous Cast Preform Powder Met.: CIP, Sinter & Forge Machining; Forging/Hot Working
Turbocharger Turbine Rotor Quantity Follows Compressor	TiAl; Durability Demonstrated + 50% Reduced Inertia = Lower Emissions - Current Cost ~2X Inconel	Same As Compressor
Valve Train ~20-40K Sets	Various Parts Demonstrated Except for Wear + Reduced Mass, Specially For Non-OHC - Cost; Lower RPM Reduces Need; Camless Designs Will Eliminate Need	Casting: Hi Volume Investment or Permanent Mold Powder Met.: Press, CIP Injection Mold; Machining
Piston Cap, Pin, Connecting Rod Quantity Undetermined	Pin & Conn Rod Prototypes Demonstrated + Reduced Mass; New Engines Revert to Fe From Al Piston - Low HD Diesel RPM Limits Benefit	Casting: Hi Volume Investment or Permanent Mold Powder Met. Press; Machining



Table 2. Summary of Heavy Vehicle Components with Moderate to Low Probability of Titanium Substitution

<b>Component / Market Size</b>	<b>Material Candidates* Status &amp; Adoption Drivers or Impediments</b>	<b>Process &amp; Development Required</b>
Turbocharger Compressor Housing Smaller Market Than Rotors	Ti – 6 Al – 4 V No Known Effort + Some Creep Problems with Al - Cost vs. Thin Walled Steel	Casting: Hi Volume Investment or Permanent Mold With Inserts; Machining Cold Spray
Exhaust System Class 8 ~7M lb/year. Potential; ~ Same For Other Classes Later	CP Ti Sheet Commercial In Niche Auto Market + Light Weight and Corrosion Resistance - Cost; Not “Shiny”	Mill Products Cost Reduction Through Continuous Casting, Sheet Rolling; Roll Compacted / Cold Spray Sheet From Powder; Anodizing, Welding, Tube Forming
Trailer Tanks & Containers <1% of Class 8	CP Ti Sheet Effort Not Expected; + Light Weight To Replace Stainless Steel in Corrosives Haul Tanks - Cost; Very Small Market	Same as for Exhaust System Application “Add On” to Exhaust If Sheet Cost is Greatly Reduced
Brakes Market Undefined	Material Candidate Not Defined No Known Effort + Light Weight; Corrosion Resistance vs. MgCl -Durability and Performance Data Lacking; Foreign Supply; Cost	First Need Performance and Durability Data to Evaluate Potential Process To Be Defined
Drive Shaft & Axles; Framework & Suspension Limited to ~7% of Class 8	Probably Ti – 6 Al – 4 V No Effort Considered + Light Weight; Corrosion Resistance - Cost of Mill Forms and Forging Needs Great Cost Reduction; Limited to Parts Where Al Properties are Inadequate	Mill Forms Cost Reduction Continuous Casting Forging; Machining

\* Note: Current designations and compositions of material candidates may change with development of alloys suitable to the new lower cost reduction processes, and non-aerospace application requirements.

Table 3. Summary of Developing TiO<sub>2</sub> Reduction Technologies

<b>Technology / Developers</b>	<b>Description</b>	<b>Status / Major Concerns*</b>	<b>Applications</b>
FFC-Cambridge Ti "Sponge" or Powder Cambridge U.; British Ti	Electrolytic reduction of solid sintered TiO <sub>2</sub> w/ CaCl electrolyte.	Bench scale demonstration; Pilot scale up planned. * Feedstock purity vs. cost; process cost elements.	All sponge use and powder metallurgy processes.
Armstrong Powder International Ti Powder	Reacts TiCl <sub>4</sub> vapor with liquid Na stream; powder cost estimated ≈ sponge & << conventional powder	Completing pilot plant * Ability to achieve fully integrated plant for lowest cost	Powder metallurgy processes for any component.
TiCl <sub>4</sub> Electrolysis Ginatta Torino Titanio	TiCl <sub>4</sub> vapor absorbed into multilayer electrolyte with progressive reduction to liquid Ti; semi-continuous	Pilot plant in operation; produce 130 mm diam Ingot; scaling to 1x4x.5 m slab * Cost not established; complex process	Slab casting; semi-continuous casting; incorporation of scrap and alloy directly; liquid feed to part casting processes.
Quenched Plasma Powder Plasma Quench Ti Inc.	TiCl <sub>4</sub> dissociation in plasma and quenching by H <sub>2</sub> ; preliminary cost estimate @ ≈ sponge & << conventional powder	Continuing development * Powder too fine – mildly pyrophoric; ability to achieve fully integrated plant for lowest cost	Powder metallurgy processes for any component.
Salt Electrolysis MIT/Sadoway	Concept to produce solid Ti by electrolysis of TiO <sub>2</sub> dissolved in molten salt	Concept only * Process needs bench scale demonstration; difference from earlier electrolytic processes	To Be Determined
Solid Oxide Membrane Boston University	Electrolysis of TiO <sub>2</sub> dissolved in molten salt, with ZrO <sub>2</sub> oxygen conducting membrane separating anode from electrolyte	Demonstrated on other oxides * Production rate vs. cost for high volumes.	To Be Determined

\* Alloy composition and properties resulting from new process routes is an issue for all new process candidates.

Table 4. Summary of Developing Ti Component Production Technologies

<b>Technology / Developers</b>	<b>Description</b>	<b>Status / Major Concerns*</b>	<b>Applications</b>
Particulate Composite Dynamet Technologies, Inc	Uses mixture of Ti, alloy additive and TiC powders with compaction sintering and HIP to form dispersion hardened alloy	Commercialized * Cost vs. coatings/cladding for wear improvement; reduced toughness	Connecting rod, other parts benefiting from stiffness; wear surfaces
Hydride - Dehydride ADMA / U. Idaho	Uses hydrided & crushed sponge or scrap, and alloy additives with compaction and sintering to form alloy	Commercialized * Needs low cost sponge/scrap; need demo of properties in complex parts; cost structure unknown	Powder metallurgy processes for any component
Hi Density Graphite Molds Santoku America	Provides permanent molds by CNC machining high density graphite body	Reportedly demonstrated * Needs confirmation of utility, life and cost	Casting of turbo rotors if combined with removable blade inserts; other cast parts
Powder Injection Molding Ti Products (Perhaps others)	Metal injection molding of complex shapes, with sintering and HIP	Developed for small parts. Under development for small rotors for microturbine * Section thickness is limiting; needs determination of usability of lower cost powders	Any simple or complex geometry part with section thickness less than limit to be determined
Cold Spray Sandia National Lab	Powder sprayed under high pressure and velocity gas; achieves high density at low temperature for coating or bulk structure.	Under Development. * Process conditions and properties need determination.	Near net shape; possible first stage of sheet forming; near net shape leaf springs or structural shapes.

## **2.0 Introduction**

Titanium has been considered for many years as an interesting candidate for application in vehicular applications due to its lightweight, corrosion resistance and mechanical properties. Over a dozen niche applications have emerged in light vehicles such as automobiles and motorcycles. Examples include the exhaust system for the Corvette, springs for the VW Lupo, and valves for the Toyota Alteza and Infinity. Nevertheless, until very recently, Ti has not made inroads into heavy vehicles. The historical barrier to entry of titanium into this market has been its high cost. There is, however, currently widespread strong interest in significantly increasing the use of Ti in the compressor rotors of heavy-duty diesel turbochargers. The driver for this increase is a severe failure problem with current Al wheels due to the increased rotor temperature and speed required to meet new emission requirements. Other components of engines, suspensions, exhaust systems and bodies have been identified as candidates for Ti. Before these opportunities can be realized, the current high cost of Ti must be significantly reduced. The high cost of Ti components comes approximately equally from the raw material (sponge and scrap), and component fabrication processes such as casting, hot working, powder metallurgy and machining.

Titanium is the ninth most abundant element, comprising 0.6% of the earth's crust. It is also the fourth most abundant structural material after aluminum (8.1%), iron (5.1%) and magnesium (2.1%). Of these four elements, only aluminum has a higher free energy for reduction of its oxide. Nevertheless, 1997 U.S. titanium production, including scrap recycle, was only 48,000 metric tons, vs. 138,000 metric tons of Mg, 7.2 million metric tons of Al, and 99 million metric tons of steel. Inversely, prices (\$/metric ton) for these metals in '97 were \$9,656 (Ti sponge), \$3,460 (Mg), \$1,440 (Al) and \$625 (Steel). Fortunately there are several serious attempts to reduce this high cost of raw material, and to introduce alternative routes to the metal other than the traditional Kroll and Hunter processes.

Fabrication processes for titanium components are generally oriented to the requirements and volumes of aerospace applications in airframes and engines. Thus castings, for example, are manufactured using conventional investment casting methods oriented to moderate volumes of components made to extremely rigorous aerospace specifications. Mill forms such as sheet, plate, bar and forging stock start out as double or triple vacuum melted ingot, and experience large yield losses during processing. Ti metal and alloy powders are produced starting with the melting and size reduction processes as mill forms, and consequently cost up to \$30 or \$40/lb. As with raw material, we are fortunate that processes are being developed to produce powders and other starting forms, and intermediate and finishing processes with promise to significantly reduce component costs. In addition, cost reduction in traditional processes is being addressed through re-evaluation of specification requirements, plant organization, infrastructure and auxiliary material and process cost reductions. The current study was undertaken to evaluate the opportunities for titanium materials in any and all of the systems of heavy-duty vehicles under the assumption of significantly

reduced cost. In addition, the study was designed to assess the likelihood of cost reduction by the new raw material production and component fabrication processes applied to these components. Finally, for those components and processes with moderate to high likelihood of commercialization, the additional development required for success was investigated.

### **3.0 The Heavy-Duty Vehicle Market**

Highway vehicles are classified by Government and industry into eight overall classes according to Gross Vehicle Weight Rating (GVWR). Some weight classes are further subdivided, but for the purposes of this study, only the heavy subdivision of Class 2 is of interest. The weight classes are grouped by the US EPA into Groups for purposes of emission regulations pertaining to engines. These groupings are shown in Table 5. As shown, the term “Heavy-Duty” encompasses all vehicles above 8,500 pounds, GVW. Class 2C includes most heavy pickup trucks and vans. Most buses, such as school and full size urban busses are included in Class 7. Highway “tractor-trailers” and many construction trucks are in Class 8. The present study of applications for titanium in heavy-duty vehicles therefore examines Classes 2C through 8.

Table 5. Eight Weight Classifications and Four Engine Classifications of North American Trucks

Class	1	2	2C	3	4	5	6	7	8
GVWR Lbs.	6,000 & less	6,001-10,000	8,500-10,000	10,001-14,000	14,001-16,000	16,001-19,500	19,501-26,000	26,001-33,000	33,000 & Over
EPA Group	Med. Duty Passenger Vehicles (MDPV)	Light Heavy Duty Engine (LHDDE)				Diesel	Medium Heavy Duty Diesel Engine (MHDDE)		Heavy Heavy Diesel Engine (HHDE)

Since data on the subdivisions of Class 2 were not readily available, most statistical data in this report focus on Classes 3-8. In this range, Class 8 contains the largest number of trucks, and is also the most cyclical in volume. Figure 1 shows the factory sales of Class 3-8 trucks since 1990 and a recent forecast.<sup>1</sup> Recovery from the deep recession of the past several years in the Class 8 industry is expected to be slow. “Normal” year volume in this class of ~250,000 is not expected again for several years. Classes 3&4 experienced a less severe recession, but equally prolonged recovery, while the slowdown in Classes 5-7 has been minor. Trucks and busses are supplied by many manufacturers, with the leadership different among the classes. Table 6 shows the market shares of these various manufacturers by class in 2001. Ford is the market share leader in Classes 2-5, International the leader in Classes 6 & 7, and Freightliner in Class 8. Others, however, have significant market shares in each class.

While gasoline engines predominate in passenger cars, SUV’s and light trucks and vans, diesel engines predominate in heavy-duty vehicles. Figure 2 shows the volumes of diesel and gasoline engines used in heavy-duty trucks and busses in 2001. Gasoline engines predominate overall in Class 2, but an informal survey showed that the heavy pickup trucks of Class 2C are currently powered ~83% by diesel engines. Discussions with several vehicle and component suppliers indicated that Class 2C and the medium

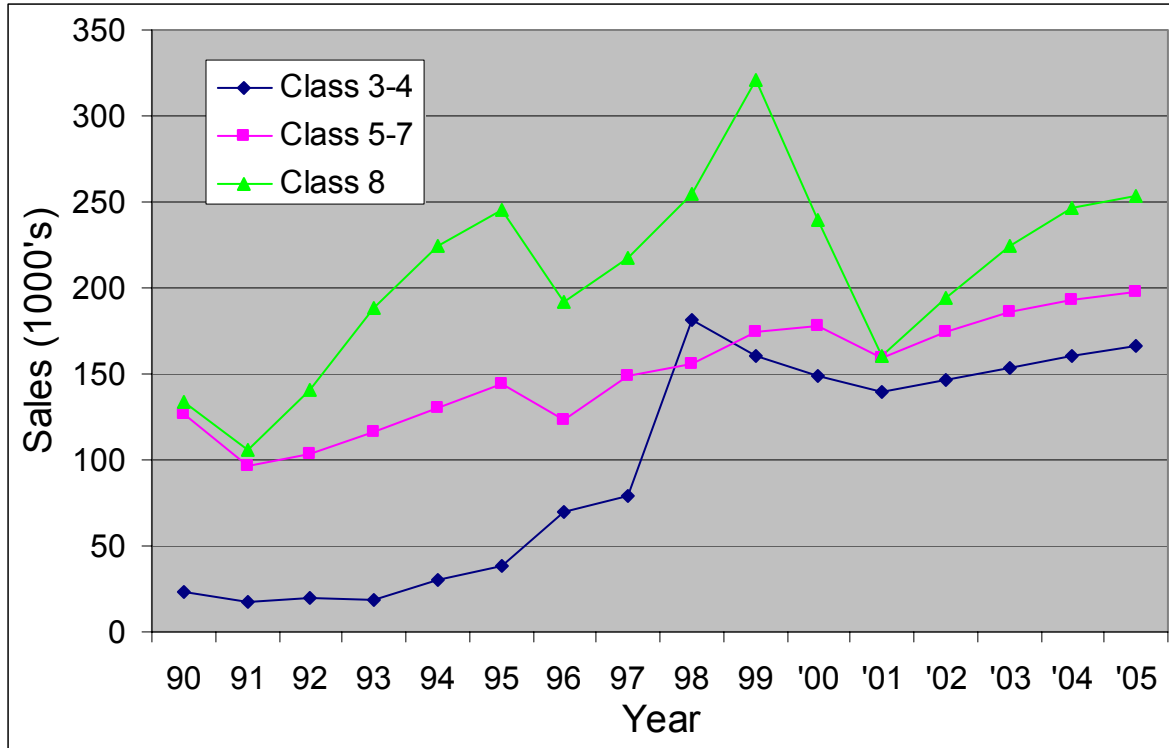

Figure 1. North American Truck Factory Sales History and Forecast

Table 6. Year 2001 Truck and Bus Manufacturer Market Shares

	Vehicle Class						
	2	3	4	5	6	7	8
Dodge	9.3%	9.2%					
Freightliner		4.2%	12.0%	3.3%	24.3%	19.8%	28.7%
Sterling				0.1%	2.0%	5.7%	6.7%
Western Star							1.5%
Ford	47.3%	83.1%	85.6%	93.9%	26.1%		
Lincoln-Mercury	1.4%						
Chevrolet	29.0%	0.6%	0.9%		2.8%	5.6%	
Cadillac	1.7%						
GMC	11.3%	2.0%	1.5%		5.3%	13.8%	
Hummer		1.0%					
Kenworth						2.7%	10.0%
Peterbilt						1.7%	10.6%
Mack							16.4%
Volvo							9.5%
International				2.6%	39.5%	50.7%	15.9%
Other							0.6%

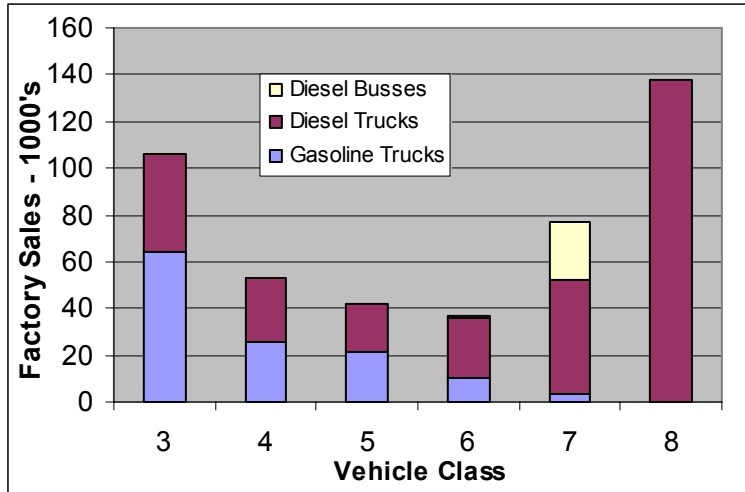

Figure 2. Diesel and Gasoline Engines Used in Trucks and Buses in 2001

duty applications are expected to increase the proportion of diesels. Overall in Classes 3-8, diesel engines powered 88.5% of vehicles in 2001, with the heavier classes being almost exclusively diesel powered. The potential application of titanium components to engines was further focused on diesels by comments from several engine and engine component suppliers that the large V-8 gasoline engines are more inherently balanced than some lighter engines so that the incentive for lightweight components is reduced. For all of these reasons, the engine portion of this study focused on diesel engines.

Supply of these diesel engines is divided among six manufacturers as shown in Table 7 for year 2001. GM engines, used in GMC and Chevy pickups and vans, are manufactured by the GM-Isuzu joint venture. International is the primary supplier of diesel engines for Ford trucks, as well as their own large share of the Class 6 & 7 truck and bus market. Caterpillar and Cummins both supply to many truck manufacturers, with Cummins being the supplier of engines to Dodge trucks. DDC supplies primarily to the Daimler-Chrysler group (Freightliner, Sterling and Western Star), while Mack supplies almost exclusively to their own truck group.

Table 7. Market shares of heavy-duty diesel engines in 2001.

Engine Manufacturer	Vehicle Weight Class							
	2	3	4	5	6	7	8	Total
Cat					73.91%	36.28%	31.48%	13.71%
Cummins	4.45%	6.75%	13.20%	3.88%	19.87%	10.35%	23.69%	10.74%
DDC					0.02%	0.01%	24.05%	5.81%
GM	24.87%		0.93%					11.12%
Mack							16.91%	4.09%
International	70.68%	93.25%	85.88%	96.12%	6.19%	53.36%	3.87%	54.54%



## 4.0 Heavy-Duty Vehicle Systems

The scope of this study encompassed all of the systems of heavy-duty vehicles. Vehicles were therefore divided into the following systems:

- Body – External shell; cab and it’s contents; tank or other bulk container
- Chassis – Structural framework; bumpers
- Suspension – Connections between chassis and axles
- Engine – Includes bolt-on components such as turbocharger
- Air Intake and Exhaust
- Drive Train – Transmission, drive shaft, couplings, axles and wheels

These systems are composed of the vehicle components, which were the central focus of this study.

### 4.1 Material Selection Drivers

Selection of material for each component is driven by many factors which generally fall into either the categories of material properties or cost. Like the automotive market, the heavy-duty vehicle market is very cost sensitive so that a change in material selection must either result in lower cost, or be driven strongly by regulations or performance. For titanium, component opportunities were found to be driven by one of three issues:

4.1.1 Emissions Reduction:<sup>2</sup> Limitations on engine emissions mandated by the US EPA are increasingly stringent. Classes 3 – 8, and Class 2 (above 8,500lb and used for freight hauling), are subject in four time periods to increasingly stringent emission regulations. Testing is performed on engines rather than vehicles. Testing is done according to the “Transient Federal Test Protocol”; however, an additional Supplemental Emissions Test, and Not-to-Exceed limits are imposed.

For these regulations, the EPA has established 3 service classes by GVWR:

- LHDDE (Light Heavy Duty Diesel Engines): 8,500 – 19,500 lbs
- MHDDE (Medium Heavy Duty Diesel Engines): 19,500 – 33,000
- HHDDE (Heavy Heavy Duty Diesel Engines): >33,000

These classes affect only the “useful life” of the vehicles, over which the emission regulations apply. The emission levels required are not different for these classes. The useful life is defined in Table 8.

Table 8. EPA Definitions for “Useful Life”

<b>Service Class</b>	<b>1998</b>	<b>2004*</b>
LHDDE	10 years/110,000 miles	10 years/110,000 miles
MHDDE	10 years/185,000 miles	10 years/185,000 miles
HHDDE	10 years/290,000 miles	13 years/435,000 miles/ 13,000 h but not less than 290,000 miles

\* Actually October 2002 because of the consent decree.

Limits of year, miles or hours are “whichever occurs first”

- Model Year 1998: Between 1987 and 2003, EPA established decreasing emission limits according to a timetable culminating in 1998 limits (in g/bhp-h) of:  
 HC:1.3                      CO:15.5              NO<sub>x</sub>:4.0              PM:0.05  
 California imposes an additional restriction of 1.3g/bhp-h total hydrocarbons.

- Model Year 2004 (Imposed Oct. 2002 due to the Consent Decree): The following are the fundamental standards. Between 2002 and 2004, engine companies apparently have some leeway to use Emission Credit Trading and other legal devices to be compliant. This standard allows manufacturers to certify engines to one of the two options shown in Table 9.

Table 9. 2004 Heavy Diesel Emission Certification Options

Option	NMHC + NO <sub>x</sub>	NMHC
1	2.4	n/a
2	2.5	0.5

Notes: (1) NMHC = Non-Methane Hydrocarbons; (2) All other emission standards to continue at the 1998 level.

- Model Year 2007: Includes both emissions and diesel fuel regulations. The emission regs are as follows, and include the SET test and NTE limits at 1.5X of the following:

- PM – 0.01 g/bhp-h effective 2007
- NO<sub>x</sub> – 0.20 g/bhp-h on 50% of sales in 2007 and 100% of sales in 2010.
- NMHC – 0.14 g/bhp-h on 50% of sales in 2007 and 100% of sales in 2010.

Diesel fuel sulfur content will be reduced in 2006 from 500 ppm to 15 ppm. This has been mandated to enable sulfur intolerant exhaust emission control technologies such as catalytic particulate filters and NO<sub>x</sub> catalysts, which the EPA believes are necessary to meet the 2007 emission standards. This is estimated to increase the price of fuel by 4.5 to 5 cents/gallon.

Among the many strategies used to achieve these regulations, cylinder pressure has been increased, which also results in higher operating temperatures. Higher cylinder pressure requires higher turbocharger pressure, with resultant higher temperature and stress in the rotors.

4.1.2 Vehicle Weight: Vehicle weight has two effects on heavy-duty vehicle operation:

- Each pound of vehicle and cargo weight gained or lost has a corresponding inverse effect on fuel economy. While there is a substantial interest in reducing overall weight for improved fuel economy, there appears to be little interest in paying a significant premium in vehicle cost to accomplish this goal.
- Commercial vehicles are subject to weight limits, primarily on the Interstate Highway System. “Bulk haul” carriers are those who transport commodities such as fuel, chemicals, milk, grain etc. in bulk quantity. These carriers often run at the maximum weight at which their vehicle is certified. In such cases, each pound of vehicle weight reduced translates to an additional pound of cargo which can be transported. Carriers appear to be willing to pay some premium for this

opportunity, with the best estimate of available premium being ~\$3 – 4/lb of saved weight. Higher and lower estimates were encountered, so that the actual available premium is likely to be commodity and operator dependent. Since the bulk-haul segment operates primarily in Class 8, the opportunity is focused on that segment. Estimates of the portion of Class 8 which is classed as bulk-haul are in the range of 5 – 7%.

4.1.3 Unique Material Properties: The materials of interest in this study were titanium alloys, intermetallics and composites. As a class, titanium materials are quite new, with the first commercial production around 1950. The 8% average annual increase in production has been driven by their unique properties: high temperature strength, light weight and high strength to weight ratio, toughness and corrosion resistance. The possibility of phase transformation, phase stabilization, compound formation and composite reinforcement has led to a very large number of materials. It is beyond the scope of this study to determine the optimum material for each potential application. However, it is instructive to consider the current materials used in these applications, the alternatives and their properties. Many of the potential applications and selected properties of current materials and titanium alternatives are shown in Table 10.

## 4.2 Vehicle Systems – Body

4.2.1 Cab Shell and Interior: The shell of most vehicles has historically been made of steel, with decreasing gage. Aluminum and polymer matrix composites are well known and increasingly used alternatives. Cab interiors are likewise composed of these same materials. Since Ti is denser than Al, Mg and polymer composites, it is not a candidate for weight savings in these components. There also do not appear to be structural or corrosion issues where the properties of Ti materials would be an advantage. No opportunity is therefore evident for Ti in these applications.

4.2.2 Container Bodies: The containers considered in this section include the box shells of freight haul trucks and trailers, pickup beds, dump bodies, refuse haulers and liquid or solid bulk haul tanks. It was found that most box shells and bulk haul tanks are currently made of aluminum alloys. Containers of pickup and dump trucks, refuse haulers and other vocational trucks are most commonly steel, with some aluminum and composite used. For all of these applications, aluminum and composites would be the light weight alternative due to density, properties and cost. Titanium materials would find only special niche applications, and then only with significantly reduced cost of sheet and light plate forms. Since most vocational trucking is not done over the interstate highway system, operators are not as concerned with vehicle weight limits, and are therefore un-interested in paying any premium for light weight materials. The small sub-segment of the liquid haul industry which carries corrosive materials currently utilizes stainless steels. Because of the corrosion resistance of Ti, this would represent an opportunity for weight reduction if the cost of commercially pure (CP) Ti sheet could be reduced to a penalty of only ~\$4/lb.

Opportunity: CP Ti sheet; ~100 ton/year, if price is < ~\$5/lb.

Development Needed: CP Ti Sheet Cost Reduction; Welding Technology

Table 10. Comparison of Current Materials with Titanium Alternatives for Components of Heavy-Duty Vehicles.

Application: Current/Candidate Mat'ls	Temp.	Yld. Strength MPa	Elong. %	Young's Mod. GPa	Density g/cm <sup>3</sup>	Comments	Ref
<b>Turbocharger Compressor</b>							
Al 7075 (T6 Condition)	RT 204°C	503 87	11 55	71	2.8		7
Al 354	RT 205°C	285 270	6 6	73.1	2.71	Yield Strength @10,000 h & 205°C = 75MPa	7
Al 355 T6	RT 205°C	170 90	3 8	70.3	2.71	Yield Strength @10,000 h & 205°C = 90MPa	7
Ti – 6Al – 4V (Annealed Bar)	RT 200°C	827-861 ~700	10	105-120	4.42	Comparison: Larson Miller est. of 0.2% creep strength at 200°C & 10,000 h would be >1GPa	4
<b>Turbocharger Turbine</b>							
Inconel 713LC	RT 760°C	751 758	15 11	197 159	8.0	760°C, 100 h Rupture Stress = 551MPa	3
Gamma TiAl Intermetallic (Ti-48Al-2Cr-2Nb Duplex)	RT 760°C	480 406	3.1 50	176	4.04	760°C, 100 h Rupture Stress = 230MPa (Duplex) = 370MPa (Transf'd)	4
<b>Engine Valves</b>							
Nimonic 90	RT 760°C	~780 ~600	30 30		8.19		6,8
Gamma TiAl Intermetallic (Ti-48Al-2Cr-2Nb Duplex)	RT 760°C	480 406	3.1 50	176	4.04	760°C, 100 h Rupture Stress = 230MPa (Duplex) = 370MPa (Transf'd)	4
CermeTi – C Composite (Dynamet Ti-6-4 + 10%TiC)	RT 540°C	965 ~515		133 ~105	4.45		5
<b>Exhaust Systems</b>							
Aluminized 1008 Steel	RT	~375	~29	~175	7.87		
409 Stainless Steel -some Al'd	RT	205	21	~193	7.8		6
304 Stainless Steel - Annealed - ¼ Hard	RT RT	205 515	40 10	~200	8.0		6
434 Stainless Steel Sheet	RT	365	23	~198	7.8		6
CP Ti, Grade 2	RT	275	28	105	4.51		4
<b>Trailer Tank &amp; Support</b>							
Al 5454 Sheet (H34 Temper)	RT	240	16	69.6	2.68		7
Al 6061 T6 Extrusions	RT	276	17	68.9	2.7		7
316 Stainless Steel - Annealed	RT	205	35		8.0	Very small market; mainly for hauling corrosives	6
CP Ti, Grade 2	RT	275	28	105	4.51		4

Table 10. Continued

Application: Current/Candidate Mat'ls	Temp.	Yld. Strength MPa	Elong. %	Young's Mod. GPa	Density g/cm <sup>3</sup>	Comments	Ref
<b>Springs – Leaf Elements</b>							
5160H Spring Steel	RT	1170-1550	7	196	7.85		6
Ti-3Al-8V-6Cr-4Mo-4Zr (BetaC Solution Heat Treated)	RT	850-895	25	88	4.82		4
<b>Suspension &amp; Chassis</b>							
A715 Grade 80 Steel	RT	550	17		7.8	Frame / Suspension	6
Al A356 T6	RT	185	5	72.4	2.68	Castings	7
Al 6061 T6	RT	276	17	68.9	2.7	Suspension	7
Ti – 6Al – 4V (Annealed Bar)	RT	827-861	10	105-120	4.42		4
(STA Extrusions - ~20mm)	RT	917-979	6	105-120	4.42		

**Notes:** A. Not all current and candidate materials are shown. B. Properties listed are approximate due to the normal variation produced by various heat treatments. C. New Ti material compositions and their properties may result from developing reduction and fabrication processes.

### 4.3 Vehicle Systems – Chassis

The framework of most vehicles is made of various steel grades. Aluminum has made some penetration for cross members in these structures but has experienced resistance to cost premium. The bulk-haul market segment discussed above is the primary user of the aluminum containing structures. The premium of \$3-4/lb which has been indicated as available for this market segment would appear to set a price target of \$4-5/lb for titanium. However, since aluminum is a viable candidate for these structural members, the actual price target for any significant application should be closer to \$1/lb. Since this is an unrealistic expectation for Ti in the foreseeable future, no viable applications are foreseen in this system.

### 4.4 Vehicle Systems – Suspension

A typical truck suspension system is shown in Figure 3. The components of these systems include various steel forgings, extrusions and rolled shapes (at < \$1/lb), plus aluminum castings (at  $\approx$  \$2/lb). Most of these components are not candidates for titanium for the same reasons as those listed above for chassis system components. One exception to this is the leaf spring elements common to each such assembly. Most of the axle suspensions of the heavier truck classes utilize air springs such as shown in the figure. On Class 8 tractors, only the front springs utilize only leaf elements. However, even the air spring assemblies utilize leaf spring elements, which can also be seen in the figure.

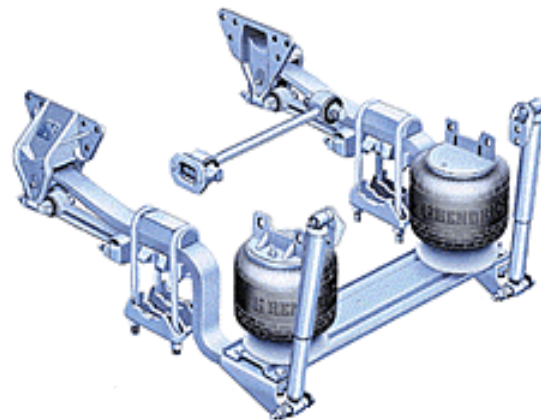

Fig. 3. Heavy-Duty Truck Suspension  
(Courtesy of Hendrickson International)

The design of leaf springs has undergone change in recent years which is favorable to the use of titanium. Leaf springs have evolved from multi-layer designs to those with single elements, or at most few elements, as shown in Figure 4. The reasons for this design change include both weight savings and performance. With multiple leaves, there is considerable hysteresis between loading and unloading portions of the cycle. This leads to a higher effective spring constant as illustrated in Figure 5. Lower leaf count is an added benefit for Ti. Since wear resistance of Ti is in general inferior to that of steel, eliminating



Fig. 4. Heavy-Duty Truck Leaf Springs  
(Courtesy of Hendrickson International)

contact between leaves also eliminates a potential wear problem. In addition, anti-friction and wear spacers between leaf ends are also being used to further reduce hysteresis.

The primary driver for interest in Ti for leaf springs is its lower elastic constant than that for steel. Elastic constant is related to spring constant through the relation:

$$K = \frac{E b t^3}{4 L^3}$$

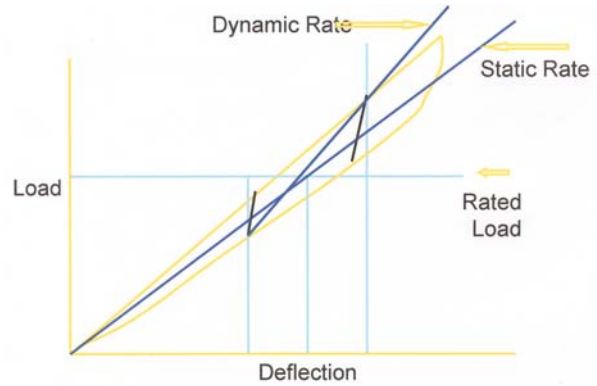

Fig. 5. Hysteresis in Multiple Leaf Springs  
(Courtesy of Hendrickson International)

With a Young’s Modulus for Ti of 88 GPa, vs. 196 GPa for 5150H spring steel, the spring constant would be reduced by 50%. A lower spring constant translates to a softer ride with the same geometry. A similar logic applies to the coil springs of passenger cars, where Ti is being utilized in the 2001 VW Lupo.

- 4.4.1 Opportunity: Over 100,000 tons of steel are used in leaf springs annually: If converted to titanium, this would represent a potential of approximately 60,000 tons. Experience with carbon-epoxy, shows that at \$8 – 10/lb market penetration is minimal. At a typical steel weight of 80 lb, cost of ~\$80, a 30 lb weight savings for Ti, and an acceptable price premium of \$3/lb, a cost target is:  
 Cost Target = \$80 + 30 lb X \$3/lb = \$170; or \$170/50 lb = \$3.40/lb  
 Achievement of this cost target is expected to result in significant market penetration, while a cost of \$7/lb would preclude significant penetration. If this can be achieved, the market potential for leaf springs is estimated:  
 Market Potential = 60,000 ton X \$3.40/lb = \$408 million  
 As will be shown later, this would also represent nearly 60% of the current world sponge capacity.

Development Needed: In addition to very significantly reduced raw material cost, manufacturing development options include:

- Permanent Mold Casting
- Forging of Low Cost Preforms
- Improved Powder Metallurgy

#### 4.5 Vehicle Systems – Engine

As discussed earlier, diesel engines powered 88.5% of Classes 3-8 trucks and busses in 2001, and an estimated 83% of heavy pickup trucks. For Ti, the incentive for application in heavy gasoline engines, which are predominantly V-8, is reduced since those engines are inherently well balanced, which reduces the value of weight reduction

of moving parts. For these reasons, this present study was focused on diesel engines. Application to gasoline engines should be revisited at a later date when significant cost reduction is demonstrated.

The potential for application of titanium materials was found to fall into three categories of interest. The components in each category will be discussed in more detail.

- Immediate Application: Properties are needed to solve a current significant problem.
  - Turbocharger Compressor Wheel and Possibly Turbine Wheel
- High Interest: Properties may be needed to enable new engine design.
  - Intake and Exhaust Valves
- Low to Moderate Interest: Enable overall weight reduction, improved engine performance or provide potential solution to problems.
  - Push Rods; Rocker Arms and Shaft; Camshaft; Valve Spring, Retainer and Rotator
  - Connecting Rods; Piston Crown and Pin
  - Turbocharger Compressor Housing

4.5.1 Turbocharger Components: As discussed above, heavy-duty diesel engine manufacturers have been forced by a consent decree to meet the Year 2004 emissions regulations by October, 2002. In spite of exceptions, credit trading and other devices, engine designs have been changed for lower emissions. These changes in general have resulted in higher operating temperatures and pressures, which also translates to higher turbocharger operating temperature, speed and pressure. As a result, aluminum alloy compressor rotors have experienced an unacceptably high rate of failure in many heavy truck applications. The failures are attributed to low cycle fatigue and possibly to creep. Ti-6Al-4V alloy has already been substituted for aluminum in a small volume (3 to 5 thousand/year), and has demonstrated that failures are eliminated. Most engine manufacturers are therefore either planning or seriously considering use of Ti. Two issues prevent total adoption, which are cost and increased inertia. The increased inertia, caused by a 60% increase in density for Ti over Al, is being addressed by rotor re-design, but is not likely to be totally eliminated. Inertia would be significantly reduced if the turbine rotor were changed from Inconel to TiAl, with a 50% reduced density. In fact, there is some concern that solution of the compressor rotor LCF problem may increase the likelihood of LCF in the turbine rotor. TiAl has been demonstrated to be superior to Inconel, and has survived hundreds of hours in service. Implementation of TiAl, however, is also subject to a similar significant cost issue.

4.5.1.1 Rotor Fabrication Process: Ti alloy and TiAl rotors are currently being manufactured using investment casting as it is practiced for aerospace components. The process is shown schematically in Figure 6. Interviews with several sources indicates that while the Ti raw material is only approximately 10 to 20% of finished casting cost, a Ti-6Al-4V compressor wheel is ~3 – 5 times the cost of an Al alloy wheel, doubling the turbocharger cost. Likewise, a TiAl turbine wheel is 1.5 – 2 times the cost of an Inconel wheel, with a corresponding effect on turbocharger cost.



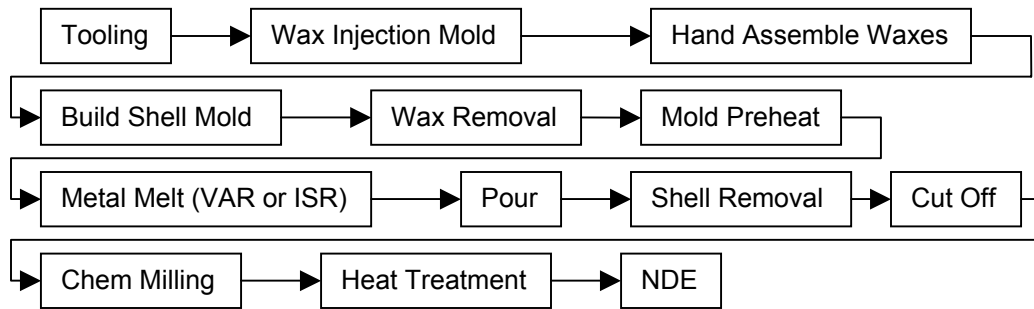

Fig. 6. Schematic Diagram of Turbocharger Rotor Investment Casting

4.5.1.2 Ti Turbocharger Market: Three to five thousand heavy diesel turbochargers per year are currently using Ti compressor rotors. Estimates by manufacturers place the penetration at approximately 30% in the heavier vehicle classes within several years, but the actual penetration will be determined by price. Some of this application will be in Classes 3-7 where operation is near maximum power, with the majority in Class 8. Another estimate places the potential penetration at 90% if the rotor cost is reduced by 50%.

4.5.1.3 Turbocharger Housing: Some problems of creep of aluminum compressor housings have been experienced due to the higher operating temperatures being utilized. Titanium castings could be a candidate for this application if the cost was very significantly reduced. No effort on this application is apparent, and thin walled steel is considered another viable candidate.

4.5.1.4 Opportunity: If Ti compressor rotor cost can be reduced by 50%, 90% market penetration potential would create a market of approximately 640,000 units, containing around 400 tons of Ti. Market value would be in the range of \$3 to 5 million.

TiAl turbine rotors, because of higher cost would have a market value in the range of \$8 to 14 million.

Development Needed:

- Current investment casting manufacturers are addressing cost reduction through modification of existing practice: Development of Non-Aerospace specifications; Dedicated work cells; Pattern and Shell Changes; Melt Practice
- Alternatives to investment molds, such as steel or high-density graphite permanent molds should be investigated. These would require use of either permanent or low cost sacrificial blade mold inserts.
- Powder metallurgy is under development for smaller rotors for microturbines. Additional development would be required to extend this to the larger rotors for heavy diesels.
- The potential for high quality powder consolidation, followed by “green” machining, should be evaluated. Analogous machining of aluminum

compressor rotors has been found to be cost effective for moderate volumes in other applications.

4.5.2 Valves: Several factors provide incentives or disincentives for consideration of titanium materials for intake and exhaust valves. With Ti valves currently at a significant cost penalty, these mixed incentives cause large variation in the interest level among manufacturers.

4.5.2.1 Operating Temperature: The higher engine operating temperatures for improved emissions discussed above are also an incentive to consider titanium materials for intake and exhaust valves. Ti alloys, however, are considered as inadequate for the temperatures of the exhaust valve. In this case, TiAl and its alloys are chosen.

4.5.2.2 Light Weight: In addition, the light weight of Ti materials provides higher specific strength, resulting in less inertia, and less vibration at higher speeds. Lighter weight valves allow lighter weight in other valve train components. The excellent corrosion resistance of Ti also provides an incentive. Engines with non-overhead cam designs have more valve train mass driving the valves, and are therefore more in need of light weight, so that their designers have more interest in Ti. Non-OHC designs are, however, less common and are older designs, so that application life for this segment may be short. Camless, or electronic valve actuation is one new engine development that is likely to increase interest in lightweight valves. A significant disincentive for light weight in heavy-duty diesels is their low operating speed of up to about 2500 rpm, vs. small engines operating up to 7,000 to 9,000 rpm. At these low speeds, valve and valve train inertia is less of an issue for performance or emissions than at the higher speeds of small engines.

Significant competition for titanium in lightweight valves is provided by hollow steel valves currently used in many gasoline engines. If found to be durable for heavy diesels, their lower cost may preclude Ti adoption.

4.5.2.3 Wear Resistance: Titanium alloys and intermetallics are noted for poor wear resistance. For this reason, coating or cladding is considered necessary for the stem, seating surface and the end surface subject to wear in valve actuation. TiN coating has been found adequate by one supplier for the stem surface, but not the seating surface or end. Another solution being studied is the use of particulate composites. Low cost solutions to this issue are clearly needed in order for Ti valves to be commercialized.

4.5.2.4 Opportunity: Quantification of interest level and market potential was not available for valves. However, an estimate may be made considering the interest that was expressed, and the number of engines produced by those manufacturers with a moderate to high level of interest. This estimate does not exceed 2 million valves per year, containing up to about 2000 tons of Ti. Market value would be in the range of \$15 – 20 million. If

all heavy-duty diesel manufacturers adopted camless designs with Ti valves, the quantity could be 4 to 5 times higher.

Development Needed:

- Design for long life and manufacturability using lower ductility TiAl alloys and composites, coatings and joined sections.
- Manufacturing process development: Casting, Powder Metallurgy, Hot Working, Functionally Graded Material.
- Joining of different Ti forms; e.g., composite to alloy or intermetallic.
- Coating development: Continuous or other high volume nitriding, low cost hard coating.
- Non-Destructive Evaluation: Improved methods for rapid detection of critical defects in powder process and joints.

4.5.3 Other Valve Train: Other components of the valve train which have been discussed include: valve springs and retainer/rotator, rocker arms, rocker arm shafts, valve yoke, push rod, lifter body and camshaft. Incentives to consider Ti materials for these applications mainly focus on light weight, higher specific strength and higher natural vibration frequency than steel. Reasons to desire light weight include lower inertia, reduced vibration and overall engine weight reduction. As with valves, reducing inertia and vibration are less of an issue with low speed heavy diesels that with small, higher speed engines. Conversely, push rod engines have greater need for such inertia reduction than OHC engines. Also, the bulk haul market segment has incentive to reduce overall vehicle weight and may be more willing to pay a premium for Ti as discussed above. With the advent of camless engine designs, the need for any valve train component is reduced. Because of these conflicting factors, and the cost premium for Ti, interest in these components is very modest and no market potential was established.

4.5.4 Power Cycle Parts: Components in the engine cylinder area to be considered include the piston, piston pin and connecting rod. Pistons are made either of aluminum or ferrous alloys. With the higher cylinder temperatures of advanced engines, there has been some move back to steel from aluminum. This has sacrificed the light weight, lower inertia, and reduced weight of crankshaft counterweight offered by aluminum but gains the temperature capability of ferrous materials. Titanium, either as a solid piston, or as a cap with aluminum skirt, would provide the lightweight advantages of Al, with the temperature capability of Fe/steel. Piston pins and connecting rods of Ti would offer higher specific strength than Al or steel, providing the inertia and weight savings desired. Interest in Ti for these components has been limited due to the high cost of Ti, and also by the lower benefit of reduced inertia in low speed heavy diesels. However, at least one company appears to have the ability to produce a connecting rod in the same cost range as the steel part. Since the need for higher temperature capability and reduced inertia appear to be increasing, and there is some promise of cost competitiveness, this portion of the engine warrants further consideration.

4.5.4.1 Opportunity: Because these components were not given high priority by the various engine manufacturers, the market potential could not be quantified. However, if cost could be made competitive with current

components, it appears likely that very significant market penetration could occur. In that event, we can consider that the total market potential for a typical “good” year in the industry, such as 2000, as ~ 740,000 engines. Then the potential would be:

740,000 engines X 6 cylinders = 4.4 million of each part

At current prices for these components, this would provide a market of nearly \$500 million.

Development Needed:

- Powder Metal fabrication, with or without HIP or forging
- Powder Metal with “green machining”
- Permanent mold casting

## 4.6 Vehicle Systems – Air Intake and Exhaust

4.6.1 Air Intake: Air intake systems, operating at ambient temperatures, have no problems with temperature, stress or durability. In addition, the air filter canisters on at least some Class 8 trucks are mounted externally and normally chrome plated for esthetics. The only advantage of Ti over steel would be weight savings for the bulk haul market segment, and Al would appear to provide more benefit at lower cost. No potential is therefore expected in these components.

4.6.2 Exhaust System: This system consists of a series of tubing sections, muffler and heat shield. The materials of construction are currently aluminized steel, Cr plated steel, and aluminized stainless steel. Because of the temperature of these components, aluminum is not an option for weight savings. Corrosion is also a significant issue due to the temperature of exhaust, which is sometimes exacerbated by road salts. Replacement cost includes the cost of the new system, labor and truck downtime. CP Ti would be a good candidate, with an expectation of “life of the vehicle” warranty. In actuality, the purity of Ti sheet useful for this application is likely to be less than is used for aerospace or chemical applications, so that cost is potentially lower. With an average exhaust system weight of ~60 lb, Ti would save 24 lb and eliminate replacement. There was a perceived lack of interest by manufacturers because of a perception that exhaust systems are Cr plated for esthetics. A random sampling of Class 8 trucks on Interstate highways was therefore carried out. Results indicated that only ~45 – 50% of trucks have Cr plated systems. Even in Cr plated systems, the muffler is not plated. Using this data, it is estimated that the average Class 8 truck could use 29.25 lb of CP Ti. Another issue to be addressed is the heat tarnishing experienced by Ti. This issue could be addressed by low cost anodizing, which provides a temperature and UV stable oxide which is blue in color. Other colors may be available. Another significant potential has not been studied, which is the expected implementation of particulate traps or other additional exhaust aftertreatment devices, particularly for year 2007 regulations. Processes to produce CP Ti sheet of the applicable purity level for this application need to be developed.

4.6.2.1 Opportunity: Subtracting the Cr plated portion of this system, and assuming that the “life of vehicle” warranty and color issues are accepted, the total market for CP Ti for Class 8 trucks only would be:

29.25 lb X 250,000 trucks = 7.3 million pounds

Other truck classes do not have the same amount of Cr plating and have smaller total system weight. However, the EPA defines the “useful life” of Class 2C through 7 engines, and therefore trucks, as 10 years compared to the 13-year life of Class 8 vehicles. Exhaust system replacement is therefore a serious issue with these vehicles as with Class 8. Using the same Ti system weight as a rough approximation for all heavy-duty vehicles gives a total market potential of roughly:

29.25 lb X 740,000 vehicles = 21.6 million pounds

Achieving cost competitiveness with stainless, and aluminized steel is a very aggressive target. However, avoiding replacement costs should provide a significant available premium. No quantitative estimate of available premium was made. However, as a first approximation, we can assume that if a system is replaced at least 2 to 3 times during vehicle life, then a premium of 2.5X may be available. With an average system weight of ~60lb, and a cost of \$100 – 150, the fabricated steel cost is estimated at \$2.00 – 2.50/lb. Fabricated Ti target cost would then be, very roughly,

Rough Target Cost = \$2.50/lb X 2.5 premium = \$6.25/lb

CP Ti sheet would need to cost some portion of that fabrication cost.

Comparing steel prices to system cost shows that fabrication costs are in the range of \$1 – 1.50/lb. An aggressive target would then be to assume that Ti could be formed on the same equipment as steel, but at a small additional cost. If Ti fabrication cost could be brought to a level of \$2.00/lb, then the available sheet cost would be ~ \$4.25/lb. Again extending this very rough approximation, the total market potential for this application would then be:

~~~ 21.6 million lb X \$4.25/lb = \$91.8 million

Use of Ti for particulate trap or other aftertreatment containers could add significantly to this potential.

Development Needed:

- Feasibility study and process for producing Ti sheet directly from low cost sponge/powder or hydrided scrap.
- Determination of required purity level
- 4-5-in.-diam tube forming and bending
- Sheet fabrication on standard equipment
- Welding
- Low-cost anodizing

## 4.7 Vehicle Systems – Drive Train

4.7.1 Drive shafts, axles, differentials, transmissions and wheels contribute very significantly to vehicle weight. Because of mechanical properties, lightweight materials other than Ti are not expected to have appreciable application. Ti materials offer reduced weight and corrosion resistance. However, as discussed above, only a small segment of the vehicle market is willing to pay a premium only for weight savings. Corrosion resistance may appear to be another benefit of Ti, particularly with increased use of MgCl on roads. However, most of the components in this category can be

coated at moderate cost to resist corrosion. Except in some weight sensitive market segments, it is unlikely that Ti will find significant application in these components.

4.7.2 Brakes are another heavy component, which are also subject to corrosion, but cannot be coated. As disk brakes increase market penetration, this may be an application for Ti if the friction and wear properties are appropriate. No information was found on this subject. In addition current suppliers are concentrated in Europe, so investigation of the U.S. potential is more difficult.

#### 4.7.2.1 Potential: Unknown

Development Needed:

- Determination of suitability of Ti materials for brakes
- If suitable, establish market size, target cost
- Powder metal or other process to meet properties and target cost

## 5.0 Titanium Raw Material Production Processes

Titanium is the 9<sup>th</sup> most abundant element in the earth's crust at 0.6%. It is the 4<sup>th</sup> most abundant structural material after Al, Fe and Mg. However, titanium metal consumes less than 5% of the Ti bearing minerals processed each year, with the majority used as purified oxide in pigment. It is well known that the applications for titanium materials have been severely limited by the price and price volatility of this metal, as well as lack of cost effective component fabrication processes. To address this issue, we must first understand the current process and world market, and then consider new, less expensive or alternate routes to the metal.

### 5.1 Titanium Bearing Minerals

The oxide titania, TiO<sub>2</sub>, is the source of all titanium metal produced. The two primary sources of titania bearing minerals are rutile and ilmenite. World reserves of ilmenite total about 1 billion metric tons, and is mined (in decreasing order) in Australia, S. Africa, Canada, the U.S., Norway, Ukraine, India and elsewhere. Reserves of rutile total about 230 million metric tons, and are mined in Australia, S. Africa, Ukraine, U.S., India and elsewhere.<sup>9</sup> The purity and impurity content of these minerals varies greatly depending on source. However, to gain an appreciation for the order of magnitude of impurities, and price of the various materials, a comparison is included in Table 11. In comparison, the ASTM specifications for CP Ti Grade 2 and Ti-6Al-4V include 0.3% and 0.4% maximum Fe, and 0.4% max and 0.4% total other non-interstitial impurities, respectively. The impurity contents of the Ilmenites and Slags obviously preclude their use for direct conversion to Ti metal. Rutile and synthetic rutile must be examined more closely as candidates, particularly in view of the potential for relaxed, altered or new specifications for application to high volume non-aerospace applications. Pigment grade TiO<sub>2</sub> may also be considered a raw material for reduction processes, but its price reflects its production using the chloride reduction and re-oxidation process cost.

Table 11. Sources, Impurities and Prices for Titania

| Source              | Content (wt. %) <sup>A</sup> |      |                  |                                |      |                               |      |      |          | Price <sup>B</sup><br>\$/lb;\$/lb Ti |
|---------------------|------------------------------|------|------------------|--------------------------------|------|-------------------------------|------|------|----------|--------------------------------------|
|                     | TiO <sub>2</sub>             | FeOx | SiO <sub>2</sub> | Al <sub>2</sub> O <sub>3</sub> | CaO  | V <sub>2</sub> O <sub>5</sub> | MnO  | MgO  | U+Th ppm |                                      |
| Rutile              | 95.8                         | 0.7  | 0.5              | 0.2                            | 0.01 | 0.4                           | <0.1 | <0.1 | 40       | 0.22; 0.38                           |
| Detrital ilmenite   | 61.5                         | 25.6 | 0.3              | 0.4                            | 0.02 | 0.2                           | 1.2  | 0.3  | 180-450  | 0.04; 0.11                           |
| Synthetic Rutile    | 92.5                         | 3.0  | 0.9              | 1.5                            | 0.02 | 0.4                           | 1.0  | 0.4  | 200-450  | 0.17; 0.31                           |
| Chloride Slag       | 85.5                         | 6.7  | 1.5              | 2.0                            | 0.14 | 0.4                           | 1.4  | 0.9  | 40       | 0.20; 0.39                           |
| Hard Rock ilmenite  | 45.2                         | 35.1 | 3.4              | 0.7                            | 0.2  | 0.2                           | 0.3  | 4.5  | 8        |                                      |
| Sulphate Slag       | 78.4                         | 7.1  | 2.8              | 3.1                            | 0.4  | 0.6                           | 0.2  | 4.7  | 10       | 0.23; 0.49                           |
| DuPont TiPure R-100 | 97.0                         |      |                  | 1.7                            |      |                               |      |      |          | 1.22; 2.10                           |

Notes: A. Ref. 10; Purity may not represent variation between sources; B. Refs. 9 and 11; Approximate prices at Ref. publication dates 1994 and 2002, converted to \$/lb.

Since the cost of titanium is often compared to that of other lightweight metals, it is instructive to also examine the cost of their feed stock minerals. Recent prices for Bauxite, the mined Al precursor are in the range of \$0.012/lb, and purified metallurgical grade alumina at \$0.07/lb.<sup>12</sup> Sources of magnesium metal ores are reported to be in the range of \$0.18/lb.<sup>13</sup> The feedstock minerals for titanium metal production can therefore be seen as a contributor to the metal price premium over Al and to a less extent over Mg, but are not the primary driver.

## 5.2 Energetics of Titania Reduction

It is often assumed that because titanium is far more expensive than steel, aluminum or magnesium, that the energy for reduction from its oxide is also significantly higher. In fact, as Figure 7 shows, the free energy of formation of TiO<sub>2</sub> is actually significantly less than that of Al<sub>2</sub>O<sub>3</sub>, and not much greater than that for the oxides of Fe or Mg. The reason for the high cost of Ti is therefore not the cost of energy for its reduction from the oxide.

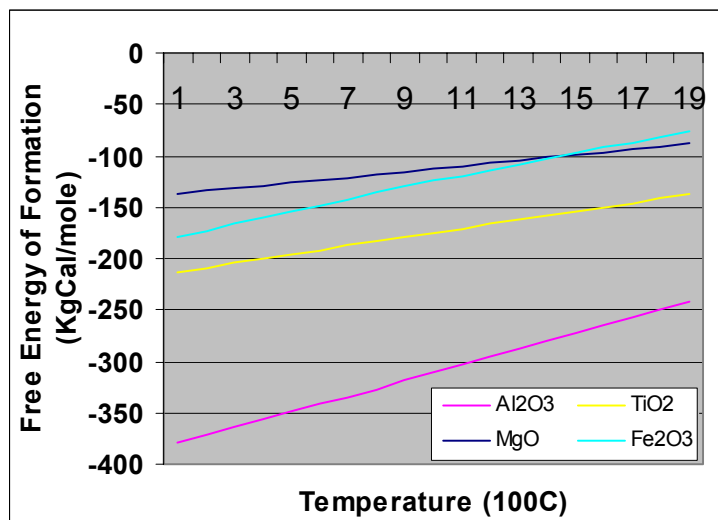

Fig. 7. Free Energy of Formation of Oxides<sup>14</sup>

## 5.3 Conventional Titania Reduction Processes

The most common processes for producing titanium do so through the intermediate step of the production of TiCl<sub>4</sub> via the reaction:



This reaction is accomplished in a fluidized bed where TiO<sub>2</sub> is reacted with petroleum coke and chlorine. The TiO<sub>2</sub> used may be either natural or synthetic rutile. The liquid TiCl<sub>4</sub> is purified by distillation to the purity desired by intended applications. The majority of TiCl<sub>4</sub> is used to produce paint pigment, which has low tolerance for many



impurities, and is therefore highly purified for that application.  $TiCl_4$  intended for Ti production may be purified to a lesser degree.

Titanium metal is produced in a retort by reacting  $TiCl_4$  vapor with either magnesium (Kroll process) or sodium (Hunter process). The majority of Ti produced uses the less expensive Kroll Process. After reaction, the product is a porous mass of Ti metal (Ti sponge) with (in the Kroll Process) unreacted magnesium and  $MgCl_2$ , with the latter being periodically tapped out of the reactor. The resulting product is then purified by leaching or vacuum distillation. The purity of the product Ti sponge, and therefore its cost, is a result of the starting  $TiO_2$  purity, and the amount of distillation of the  $TiCl_4$  which is carried out.

#### 5.4 Titanium Sponge

In 2001, world sponge production was about 64,000 metric tons, and prices averaged about \$7.91/kg (\$3.59/lb). The supply and price for sponge has, however, been very unstable as shown in Figures 8 and 9. Prior to 1990 and the collapse of the Soviet Union, supply and price were virtually independent of Soviet production. In fact, during that time, the Soviets produced very large quantities of Ti for use in submarines and other military systems. That capacity became available after about 1990, but was largely taken out of production within a few years. The plants were either mothballed or used for spare parts, but the infrastructure, and much of the plant remained. Today, ~47% of U.S. imports come from Russia, and another 12% from Kazakhstan, with 37% coming from Japan. Since 1995, world capacity has decreased from 130,000 metric tons, to ~102,000 metric tons. Reportedly,<sup>15</sup> very large capital investment would be required to revitalize the former Soviet capacity, with capital being largely unavailable.

The discussion above may appear to indicate that sponge is a single commodity. However, this is not the case, and there are a variety of sources, purities and prices. Purity depends on feedstock used and the post-reaction purification, with various grades intended for different markets. The price for sponge varies with purity level as well as world market cycle. Table 12 provides an indication of this variation for several world sources. It is important to note that the only remaining U.S. producer of sponge, Timet, consumes all production internally so that no market price is available. It is important to recognize that in the past the majority of titanium produced, and alloys developed, were intended for aerospace applications. Those compositions, and the purity of the starting material, may not be optimum for ground vehicle use. Producers have already begun developing alloys, using appropriate starting materials, with lower cost for the automotive market.

Table 12. Purity and Recent Average Price for Available Ti Sponge<sup>12, 16, 17</sup>

| Source Grade  | Ti Min % | Impurities Max % |      |      |       |      |      |      |       |      | Price \$/lb |
|---------------|----------|------------------|------|------|-------|------|------|------|-------|------|-------------|
|               |          | Fe               | Si   | Mg   | Mn    | Ni   | Cl   | C    | N     | O    |             |
| <b>Europe</b> |          |                  |      |      |       |      |      |      |       |      |             |
| TG100         |          |                  |      |      |       |      |      |      |       |      | 2.79        |
| TG130         | 99.56    | 0.13             | 0.03 |      |       | 0.04 | 0.10 | 0.03 | 0.03  | 0.04 | 2.34        |
| <b>Japan</b>  |          |                  |      |      |       |      |      |      |       |      |             |
| S-90          | 99.8     | 0.03             | 0.02 | 0.04 | 0.002 |      | 0.08 | 0.01 | 0.006 | 0.05 |             |
| S-95          | 99.7     | 0.04             | 0.02 | 0.04 | 0.002 |      | 0.08 | 0.01 | 0.006 | 0.06 |             |
| M-100         | 99.6     | 0.08             | 0.02 | 0.05 | 0.005 |      | 0.10 | 0.02 | 0.010 | 0.07 |             |
| M-120         | 99.5     | 0.12             | 0.03 | 0.06 | 0.010 |      | 0.12 | 0.02 | 0.015 | 0.10 |             |
| OTA-L         | 99.5     | 0.15             | 0.03 | 0.1  | 0.01  |      | 0.18 | 0.13 | 0.02  |      |             |
| <b>China</b>  |          |                  |      |      |       |      |      |      |       |      |             |
| 0Trade        | 99.76    | 0.06             | 0.02 |      |       |      | 0.06 | 0.02 | 0.02  | 0.06 |             |
| 1Trade        | 99.65    | 0.01             | 0.03 |      |       |      | 0.08 | 0.03 | 0.03  | 0.08 |             |
| 2Trade        | 99.54    | 0.15             | 0.04 |      |       |      | 0.10 | 0.03 | 0.04  | 0.10 |             |
| 4Trade        | 99.15    | 0.35             | 0.05 |      |       |      | 0.15 | 0.04 | 0.06  | 0.20 |             |

Figure 9 also shows the dramatic drop in price (in 1998 dollars) of titanium during the first two decades of its production. The first commercial production did not occur until 1949, so the large initial decline actually occurred during only one decade of that production. Much has also been made of the volatility of prices for Ti. When viewed in the historical context, and as a percentage of price trend line, only the period of ~1975 to 1985 shows a dramatic volatility. This was a period of large fluctuation in orders and cancellations for commercial aircraft, which dominated the demand for Ti. It is interesting to compare the history of titanium pricing vs. production with similar data for aluminum and magnesium, the other two light weight structural materials, shown in Figures 10 and 11. All three show significant price declines in the first decade(s) of their production. All three also show price volatility, although Mg has shown much more stability except for a near doubling in the early 1970s, which was sustained. Aluminum has shown very significant instability over much of its history. There is therefore little logic in arguments against Ti for vehicular applications on the basis of comparing price stability with other light metals.

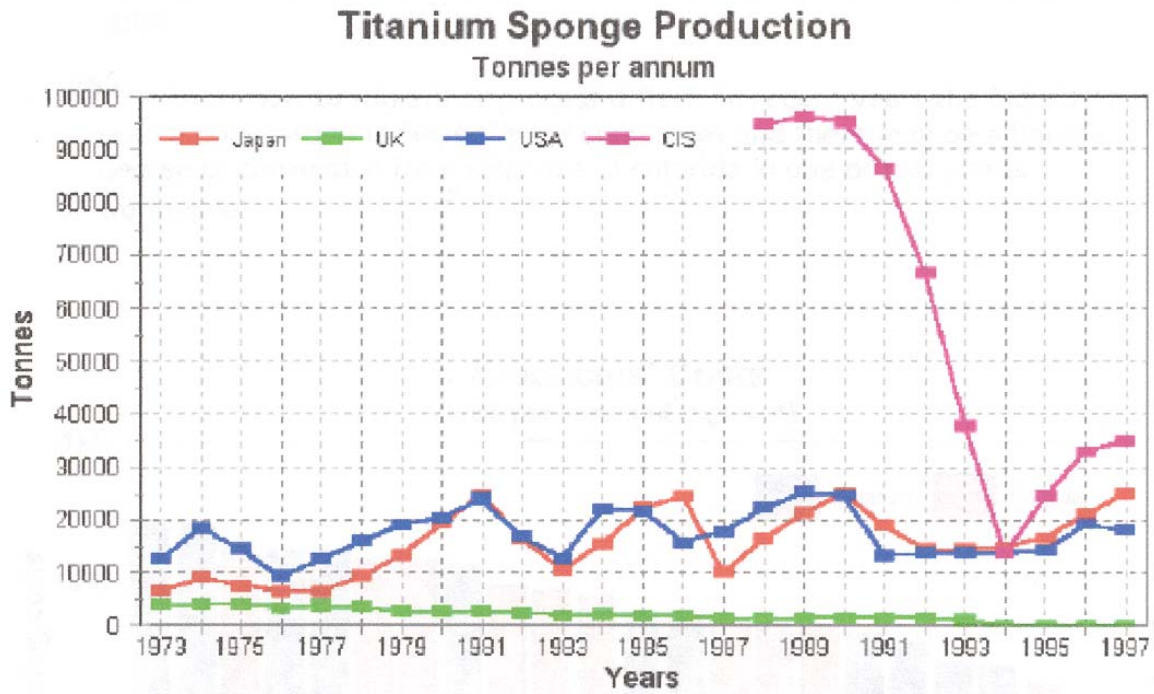

Figure 8. Variation in Titanium Sponge Production<sup>18</sup>

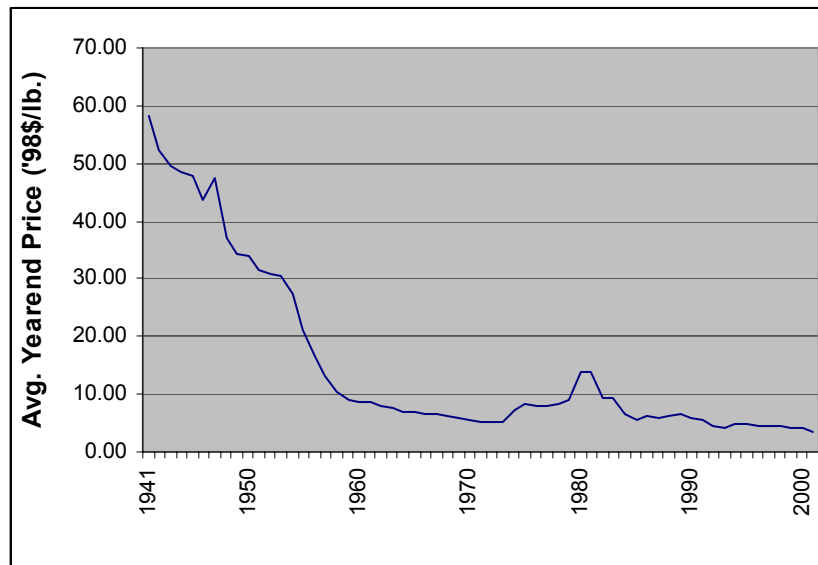

Figure 9. Variation in Titanium Sponge Price<sup>9</sup>

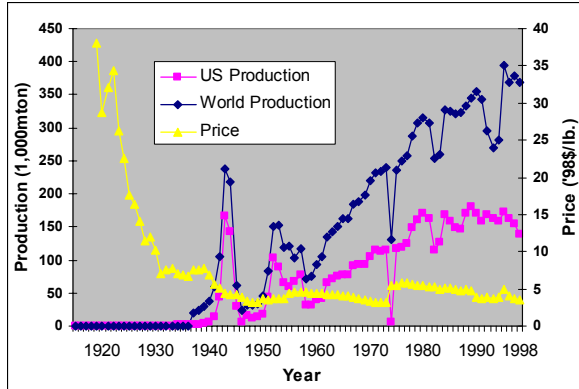

Fig. 10. Production and Price History for Magnesium<sup>19</sup>

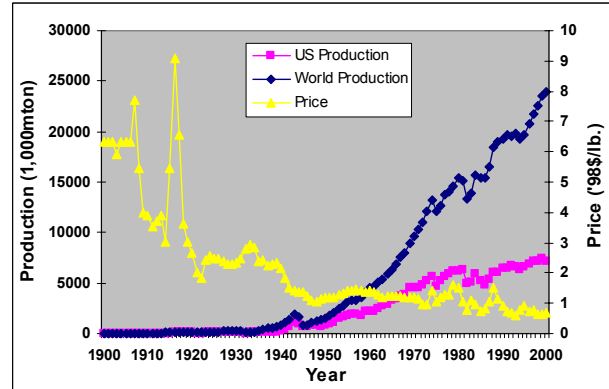

Fig. 11. Production and Price History for Aluminum<sup>20</sup>

Two other factors are illustrated by these figures. First, all three metals have reached a price trend which is not likely to change with the current technology. The declining price trend is accomplished by process efficiency improvements, but very significant declines are not likely with the current technologies. Second, current prices for Mg and Ti are nearly identical. Significant cost reduction for titanium components must therefore be sought by both lower cost primary reduction and by post-reduction processing.

### 5.5 Titanium Scrap Usage

In addition to sponge, the titanium industry recycles a considerable quantity of scrap. Figure 12 shows the annual metric tonnage of scrap and sponge consumed in the U.S. The ratio of scrap to sponge has been steadily rising until they are nearly equal contributors in recent years. The obvious reason for this increase can be seen in the price, also shown in Figure 12 and in comparison to sponge price shown in Figure 9. In spite of the radical volatility of scrap prices, it is still considerably less expensive than even the current reduced level of sponge prices. Many melting and casting manufacturers use very high levels of scrap; some reportedly use 100% scrap. In 2001, the U.S. imported 10,700 metric tons of scrap, primarily from France, Germany, Japan and the U.K. We simultaneously exported 7,030 metric tons, while consuming 17,000 metric tons. Scrap is therefore a vital factor in cost and supply of Ti metal. One key issue, which must be kept in mind as large tonnage vehicular opportunities are considered, is the world scrap capacity. It is highly likely that significant increases in demand would not be able to depend on increased scrap supply to restrain costs.

### 5.6 New Titanium Production Processes

Soon after the Kroll process was introduced, it was predicted that an electrolytic process would replace it within 15 years. It was assumed that an equivalent to the Hall-Heroult process for aluminum production would be developed. However, many attempts have been made, with no commercial success. Reasons include the higher melting

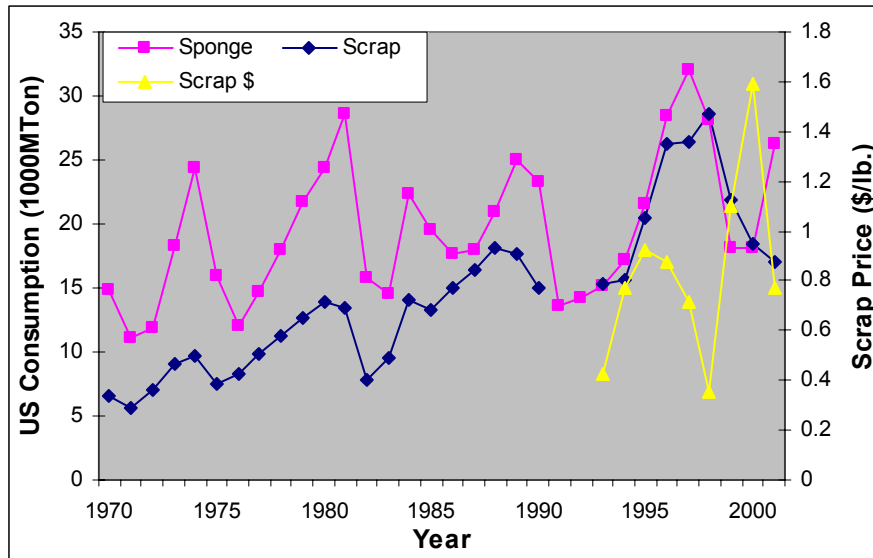

Fig. 12 Annual U.S. Ti Scrap and Sponge Consumption and Scrap Price<sup>9</sup>

temperature of Ti, multiple Ti valence states, lack of a solvent for Ti which is equivalent to cryolyte for Al and the impurities in natural rutile. Fortunately, in spite of past failures, new approaches continue to be explored. It is often assumed that a new process must avoid the  $TiCl_4$  intermediate in order to be cost effective. This is reasonable since the cost of  $TiCl_4$  at approximately \$1.50/lb of contained Ti is above the cost of smelted aluminum, whereas natural rutile costs only ~\$0.37/lb of Ti and synthetic rutile sells for ~\$0.28/lb of Ti. It must be remembered, however, that the cost of raw material is normally much less than half of a component cost. Forms of the raw material which enable significant cost reduction in component fabrication may also produce lower cost. Such is likely to be the case with processes which produce Ti powder at cost much lower than current prices which are in the range of \$20 -40/lb. The following approaches to cost reduction have therefore been investigated.

5.6.1 FFC – Cambridge Process: This process was developed at Cambridge University by D. Fray, G. Z. Chen and T. Farthing and has been licensed to British Titanium. It is shown schematically in Figures 12 and 13. This process is most easily understood as the electrolytic reduction of solid  $TiO_2$  which is immersed in a molten CaCl electrolyte. A  $TiO_2$  powder is formed by conventional ceramic processing into a rectangular sintered cathode incorporating a conducting wire. This cathode is then immersed in the electrolyte with a graphite anode. Reportedly,<sup>21</sup> removal of a small amount of oxygen from the electrically insulating rutile phase converts it into the highly conducting Magnelli phase ( $TiO_{2-x}$ ). Continued electrolysis removes oxygen from the cathode, where it dissolves in the electrolyte and is then removed as  $O_2$ , CO or  $CO_2$  at the anode. At the voltages used, no calcium is deposited. Process times are between 24 and 48 h, with resulting oxygen levels below 1000 ppm and  $N_2$  of 5 – 20 ppm. Longer processing times allow lower  $O_2$  levels. Simultaneous reduction of several oxides has reportedly allowed production of Ti-6Al-4V alloy.

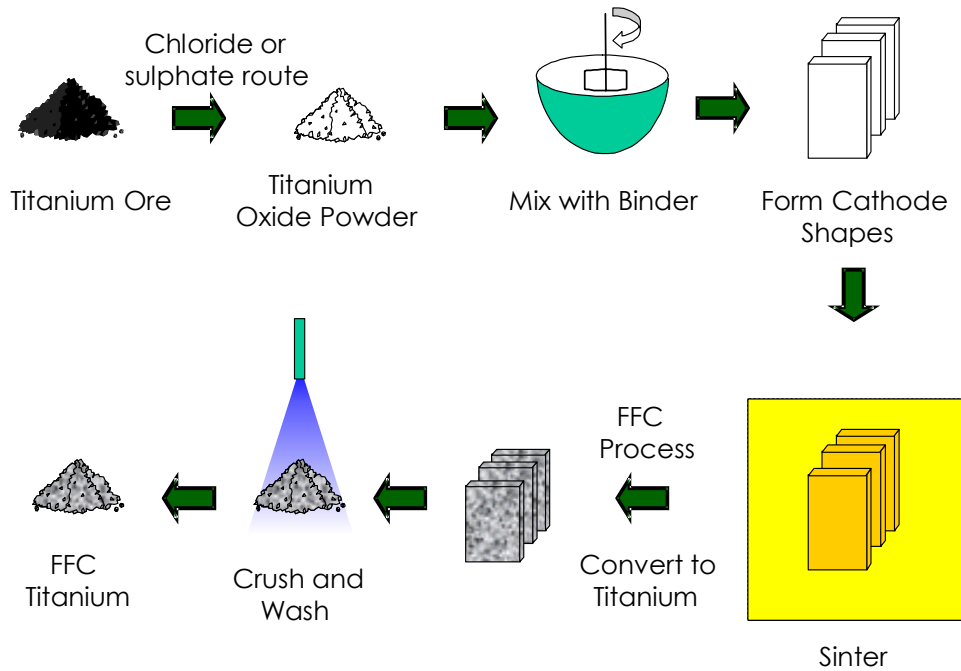

Fig. 13. Schematic Description of the FFC-Cambridge Process<sup>18</sup>

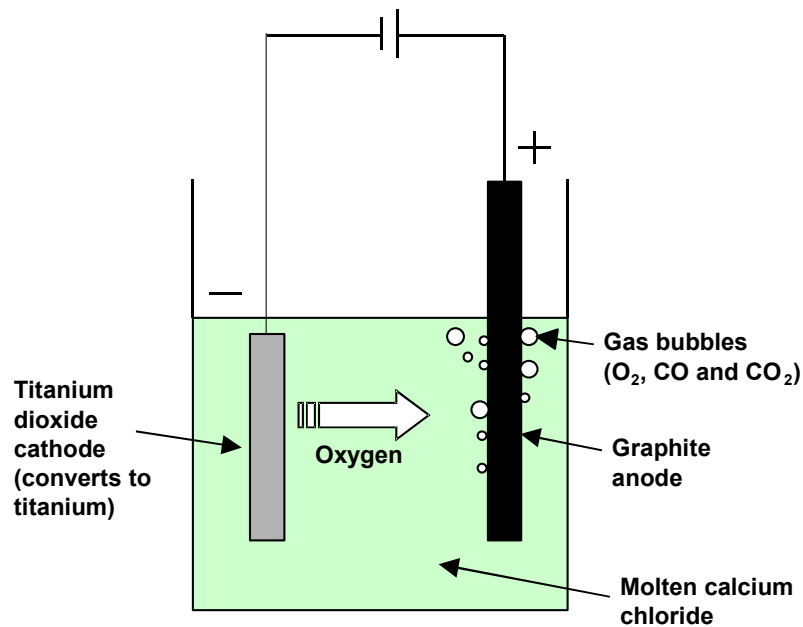

Fig. 14. Schematic Description of the FFC-Cambridge Process Reduction Step<sup>18</sup>

In recent communication, a second 1-kg cell was in place, with plans to install a fully integrated pilot plant to be in operation early next year. Scale up of this process would require multiple cells, with the cell size limited by the practical limit of cathode thickness for reasonable process times. This limit is due to the rate limiting step of diffusion of oxygen ions out of the porous anode. Large scale continuous operation would require that cathodes be sequenced through each cell in batch-continuous mode.

There is at present a significant uncertainty regarding the  $\text{TiO}_2$  feedstock to be used in this process, its cost and the resulting impurities in the product Ti. As shown above in Table 9, Ilmenite and slag contain much too high a level of impurities to be used directly. Natural and synthetic rutile contain much lower impurity levels, which may allow acceptable non-aerospace properties, but this is to be determined. Pigment grade  $\text{TiO}_2$ , has lower levels of impurity, but is also more expensive. There are two types of pigment  $\text{TiO}_2$ , that made by a sulphate process from Ilmenite, and another by the chloride process from rutile. The sulphate product, generally called anatase had market prices in 2000 – 2001 of \$0.92 to \$0.94/lb. The chloride product had market prices in the same period of \$0.99 to \$1.09. It should be noted that if pigment grade  $\text{TiO}_2$  must be used, then this process does not avoid the use of  $\text{TiCl}_4$ , since that is the chloride process used with rutile, and the sulphate process has similar costs.

Another issue remaining unresolved with this process is the expected price of product Ti. A recent study has been conducted by Camano Associates on this as well as two other Ti production processes.<sup>22</sup> No details on the study of the FFC-Cambridge process have yet been released. Preliminary indications are that the study showed costs in the same range as current sponge prices. This assessment differs from the projections of British Titanium. These studies also have not included the expected profit which an enterprise would require. Until reports are issued, it is premature to pass any judgment on the cost/price issue. It is also likely that refinements will further reduce cost. Preliminary discussion on the study pointed to issues of the cost of the feedstock and the cost of the ceramic processing required to form the cathode. The cathode forming cost estimate is believed to be excessively high, reflecting advanced ceramic specifications. Use of forming and firing methods used in conventional ceramics or refractory production should be investigated for significant cost reduction. The issue of feedstock selection vs. resulting material properties remains the key issue.

5.6.1.1 Remaining Concerns: Before the potential for the FFC-Cambridge process can be assessed, it will be necessary to test materials using Ti and alloys from several feed stocks to determine the effect of the feedstock impurities on properties. The cost and performance of materials from this process may then be assessed.

5.6.2 International Titanium Powder (Armstrong) Process:<sup>23</sup> This process produces Ti by the reduction of  $\text{TiCl}_4$  with sodium, as does the Hunter process. However, ITP has devised a nearly continuous process in contrast to the batch mode of Hunter. A schematic of this process is shown in Figure 15. There are several key points in this process which must be understood.

The reaction which takes place in the “Ti Reactor,” is continuous. Liquid sodium is pumped through a cylindrical chamber containing a centerline second tube.  $\text{TiCl}_4$  vapor is injected into the sodium stream through this inner tube/nozzle. Reaction occurs immediately downstream of the nozzle, with Ti powder being carried out in the excess Na stream. Ti, Na and NaCl are separated by filtration, distillation and washing. The

powder produced has a purity level near to that of commercial purity Ti, including a Cl content of 50 – 100 ppm. ITP has achieved repeatable oxygen levels in lab scale batch processing of 1500 ppm, and sometimes at or below 1000 ppm. They believe that by continuous operation of the new pilot plant, they can consistently produce powder with less than 1000 ppm O<sub>2</sub>. By simultaneous reduction of other metal chlorides, it may be possible to produce alloy powders. This may be an unnecessary complication if some of the powder metallurgy processes under development and discussed below, are able to use unalloyed powder and produce alloying during the sintering process.

Another key point about this process is that since TiCl<sub>4</sub> vapor is used, the evaporation step also functions as a second purification after the initial distillation – purification performed in TiCl<sub>4</sub> manufacture. Lower grades of rutile could therefore be used as feedstock, as well as less distillation of the TiCl<sub>4</sub>, both of which would lower cost, but to an unknown degree at present.

Figure 15 shows several recycle steps either in the present small scale and pilot plant, or envisioned for a future integrated plant. The Camano cost study also investigated this process and also concluded that the “most probable” scenario produced Ti powder at near the present cost of sponge (\$3.54/lb). An “Optimistic” scenario, which includes recycling of NaCl and an integral TiCl<sub>4</sub> reactor would produce powder for ~\$2.15/lb. This latter scenario assumes that TiCl<sub>4</sub> can be produced at a cost below its purchase price from outside vendors. These cost estimates, however, do not include the profit required by a business enterprise. On the other hand, production of a quality Ti powder at this price level is a great improvement over the current cost of Ti powder, which may be in the range of \$20 – 40/lb.

ITP is in the process of completing a pilot plant for this process. Whereas the initial lab scale process was operated in a batch mode, the pilot plant will operate in a continuous mode. The Ti reactor is of the same design, and is reported to be capable of producing ~2 million pounds per year of powder. Scale up beyond that level would involve multiple reactors of the same design. Economies of scale would likely come from integrating some of the auxiliary processes.

5.6.2.1 Remaining Concerns: This process has been demonstrated to produce useable powder, and is close to initial scale up. Remaining issues include the degree of recycling of reactants which can be accomplished, and the capital cost of a fully integrated plant. This study of opportunities in heavy vehicles showed that applications would require the material cost represented by the “Optimistic” scenario for this process.

5.6.3 Ginatta Process:<sup>24,25</sup> Dr. Ginatta developed the fundamentals of this process as a thesis at Colorado School of Mines, and has continued development, resulting in a pilot plant. This is an electrolytic process, in which TiCl<sub>4</sub> vapor is injected into a multilayer electrolyte where it is absorbed. This “multilayer cathodic interphase” separates the molten Ti cathode from the graphite anode through which the vapor is injected. This multilayer phase consists of ions of K, Ca, Ti, Cl, F and some elemental K and Ca. The



layers contain various oxidation states of the species, with the bottom layer producing liquid Ti, which falls to the molten pool. Ti is contained by a water-cooled Cu crucible, so that a frozen layer of Ti at the bottom and slag around the electrolyte provide insulation and protection from Cl. The current pilot plant produces 130 mm diameter ingot. Work is being conducted to enable production of slabs 1 x 4 x 0.5 m. In addition to molten Ti production, solid scrap Ti and alloying elements can be introduced to utilize low cost scrap and adjust composition. Since molten metal may be tapped off at any time after composition equilibration, the process is semi-continuous, and could also be used to provide liquid metal for casting operations. While  $TiCl_4$  is used, the cost of sponge production and possibly of vacuum remelting may be avoided.

5.6.3.1 Remaining Concerns: The process is quite complex, so is not likely to be duplicated by others. Confirmation of the product quality would be advisable. As mentioned, the use of  $TiCl_4$  is a limiting factor on cost reduction if its production is not integrated into the process. Likewise, Cl gas must be either be disposed, sold or recycled. No cost study appears to be available.

5.6.4 Plasma Quench Technologies Inc. Process: This process involves the thermal dissociation and reduction of  $TiCl_4$ . To accomplish this, it passes  $TiCl_4$  through an electric arc in a vacuum chamber, which heats the vapor to over 4000°K forming a plasma. A stream of hydrogen gas carries the gas through a Delaval nozzle, where it expands and cools. The combined effect of rapid cooling (quenching), the reducing effect of hydrogen and formation of HCl prevent back reaction of the Ti and Cl. A very fine hydride powder is therefore produced, which needs to be dehydrided. Four issues concerning this process are of concern: 1) Its use of  $TiCl_4$ , as with other processes, limits the cost reduction achievable; 2) It is very energy intensive, so concern with future energy prices must be considered; 3) It produces a powder which is so fine as to be mildly pyrophoric; 4) The HCl reaction product must be disposed, sold or recycled. On the positive side, the small size of the reactor keeps capital cost low. Scale up would apparently require multiple reactors since the reaction is expected to be quite geometry sensitive. PQTI is further developing the process in an attempt to increase powder size. Another approach to powder size is proposed which involves briquetting the powder which could reduce its usability in powder metallurgy processes. The other issues listed are cost drivers which will ultimately determine powder cost. Camanoe has modeled the cost of this process and found a mid-value, or "likely current" scenario, cost of ~\$3.26/lb, just below the recent world market price for sponge. Briquetting would add ~\$0.50/lb. As with the other estimates discussed above, this cost does not include profit which an enterprise would require. As with the ITP process, powder cost near that of sponge would still be an advantage over current powder prices.

5.6.4.1 Remaining Concerns: Because of the powder particle size issue, this process requires considerable further development. When modifications achieve that objective, then the cost analysis should be modified to reflect those changes.

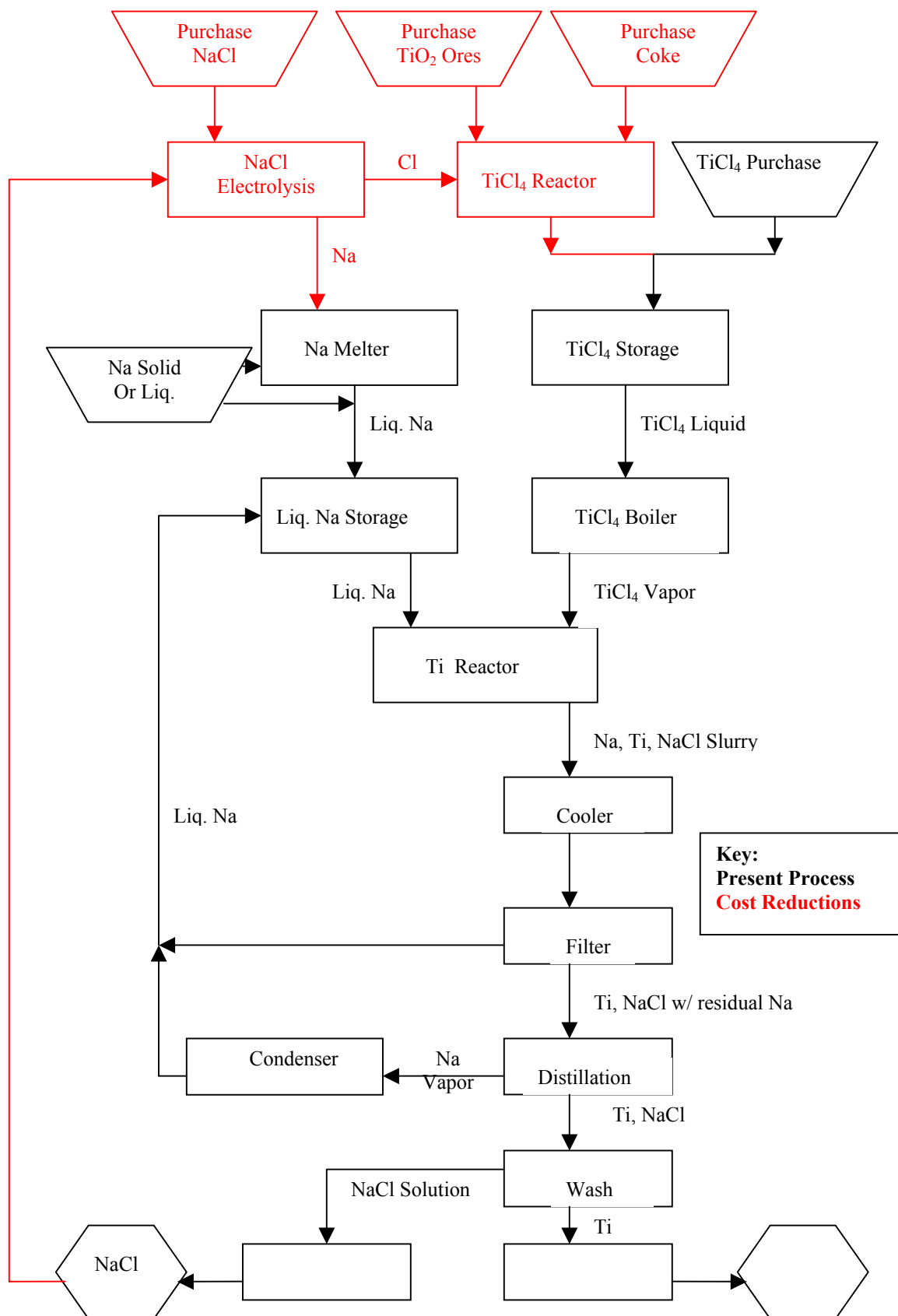

Fig. 15. Schematic Description of the ITP Process<sup>26</sup>

5.6.5 MIT Electrolytic Reduction:<sup>27</sup> Prof. D. Sadoway has proposed a process for electrolytic reduction of  $\text{TiO}_2$  via solution in a BaO melt. By operating at sufficiently high concentrations of the solvent, the conductivity of the bath is changed from semiconducting to ionic, so that proper heat balance and electrolysis can be achieved. To date, only potentiostatic research has been conducted, and no actual  $\text{TiO}_2$  electrolysis has been reported. The results however show that such a process should be feasible and warrants further investigation.

5.6.5.1 Remaining Concerns: This process is in an early research stage, so no assessment of ultimate commercial feasibility is relevant. No assessment can be made of the difference between this process and earlier electrolytic process attempts. The research should, however, be continued in order to demonstrate Ti production and to answer the practical and economic questions.

5.6.6 Boston University – Solid Oxide Membrane (SOM) Process:<sup>28</sup> Prof. U. Pal has developed an electrolytic process of oxide reduction which utilizes a solid oxygen ion conducting membrane to separate an anode from a melt containing the oxide to be reduced, into which is also placed the cathode. The melt containing the desired oxide is designed to be primarily an oxygen ion conductor. The process has reportedly been used to produce Mg, Si and Fe-Si alloys, and is proposed for Ti. The advantage of this process over other electrolytic processes where the anode is also immersed in the bath is the use of a membrane to separate oxygen from the reduced titanium.

5.6.6.1 Remaining Concerns: A separate study would need to be done to understand all of the differences between past and present electrolytic processes. The production rate and economics of the SOM process have not been addressed.

## **6.0 Titanium Component Production Processes**

Turner and Hansen<sup>29</sup> estimated the cost elements in production of Ti alloy plate as: 38% raw Ti as sponge, 15% in two arc melting steps, and 47% in fabrication of a one inch thick plate. For investment casting of turbocharger compressor rotors, the cost of raw material is estimated as somewhat less than 30%. While new titanium reduction technologies may have potential to reduce cost by 10 to 15%, major cost reductions will need to be accomplished in component production processes. Cost reduction may be accomplished by either modifying current processes to improve efficiency or by utilizing alternative process routes that reduce the number and complexity of process steps. Simplification may come due to the form of products of the new reduction technologies.

### **6.1 Casting Technology**

Examples of the first approach are the efforts currently under way at investment casting operations to modify specifications, reduce shell system costs, and streamline operations for high volume. These efforts were discussed above in Section 4.5.1. Permanent steel or high-density graphite<sup>30</sup> molds need to be investigated further. The opportunity to utilize lower cost, semi-continuous molten Ti alloy should also be studied; processes such as the Ginatta approach discussed in Section 5.6.3 may provide a viable option.

### **6.2 Powder Metallurgy**

The powder metallurgy industry is well developed. It is the most well developed of the near net shape manufacturing technologies which promise significant reduction in component production costs. The primary obstacle to greater utilization of PM has always been the high cost of powder. For example, approximate prices were obtained for -200 mesh CP Ti powder in the range of \$30 – 40/lb in 100 lb lots. Alloy powders, such as Ti-6Al-4V, are priced in the same magnitude. This price will vary depending on alloy, mesh size, purity, quantity, supplier and negotiation. However, it is indicative of the magnitude of current prices. The applications and target prices discussed in Sections 4.2 – 4.7 will obviously not support powder in this price range. One supplier offered crushed Ti sponge in the 30 – 60 mesh size in the range of \$7 – 10/lb. Even this probably unusable powder is too expensive for the applications discussed. The new powder production technologies discussed in Section 5.0 offer promise of cost affordable product. Efforts to utilize this new powder and technologies are being pursued, as discussed in the following subsections.

6.2.1 Ti Hydride – Dehydride Process:<sup>31</sup> This process was developed at IMP / Ukraine, and brought to the U.S. by ADMA Products, with collaboration by the Institute for Materials and Advanced Processes at the University of Idaho. The process is shown schematically in Figure 16. Low-grade sponge may be used, such as TG-130 at 99.56% Ti, from Russia / Kazakhstan, which in 12 X 70 mm pieces sold in March 2002 on the European free market at ~ \$2.35/lb. Alternatively, Ti scrap may be used, which as turnings sold on that market in the same month for \$0.88 – 0.97/lb. Alloys may reportedly be made by adding alloy elements to the hydride, which diffuse and form the alloy during sintering. No HIP is apparently necessary, and properties for Ti-6Al-4V are obtained which are comparable to annealed bar. According to those involved, complex geometries are pressable and equal density is achieved over a wide range of pressing pressure. A connecting rod weighing 0.7 lb, with claimed cost of \$3 – 3.50 (~\$4.65/lb), is shown in Figure 17 along with other parts made by this process.

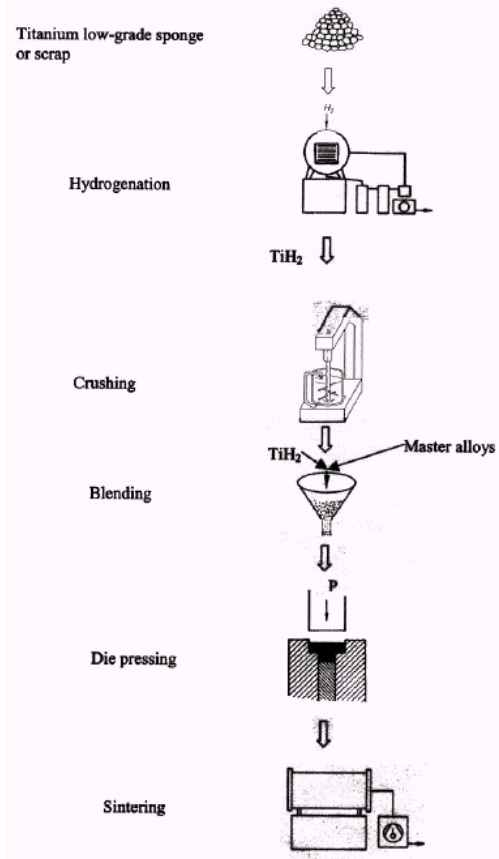

Courtesy of U. Idaho / ADMA  
 Fig. 16. The Hydride – Dehydride Process

6.2.1.1 Remaining Concerns: As with other processes which rely on the current low prices and relative price stability of sponge and scrap, cost for this process is also subject to future instability in the metal market. This concern would be removed if one of the new powder production processes is commercially successful at the low end of projected cost. Similar to other powder technology, it will be necessary to determine the defect populations and distribution, and the mechanical properties in components with complex shapes. Since the process is apparently ready for commercialization, process demonstration and cost modeling of fabrication of some of the promising heavy vehicle components should be performed.



Figure 17. Components made by Hydride –Dehydride Process (Courtesy of U. Idaho / ADMA)

6.2.2 Dynamet Particulate Reinforced Composites:<sup>32</sup> Poor wear resistance is one of the serious limitations of titanium materials. Its consideration for both automotive and heavy vehicle valve train components has been consequently delayed. Conventional solutions considered are cladding or coating with more wear resistant materials. Dynamet’s CermeTi<sup>®</sup> composites offer an alternative solution. These materials are based on alloys such as Ti-6Al-4V-2Sn and contain 10 – 20% particulate reinforcement such as TiC. The process for producing components via this process is shown schematically in Figure 18. Processing, referred to as the Cold – Hot Isostatic Pressing (CHIP) process, resembles normal powder processing methods. One significant innovation, shared with the hydride-dehydride process above, is the use of unalloyed CP Ti powder and master alloy addition powder which is blended as shown. A containerless HIP step at 899°C, 103 MPa for 2 hours in argon produces full density material. Typical mechanical properties are given in Table 8. CermeTi<sup>®</sup> materials have higher strength and elastic modulus, but lower ductility than unreinforced material. These properties would be an advantage for a connecting rod or the wear surfaces of valves, but a disadvantage for leaf springs. The extent of composite stiffening and hardening can be tailored with the TiC content. Figure 19 shows several parts made with this process.

6.2.2.1 Remaining Concerns: While this material provides a viable solution to the Ti wear issue, the cost of this approach vs. other wear surfaces should be determined for candidate components. For some components, the ~50% reduction in toughness with these composites could be a serious limitation. Finally, the properties and defect distributions in actual parts should be studied to assure reliability.

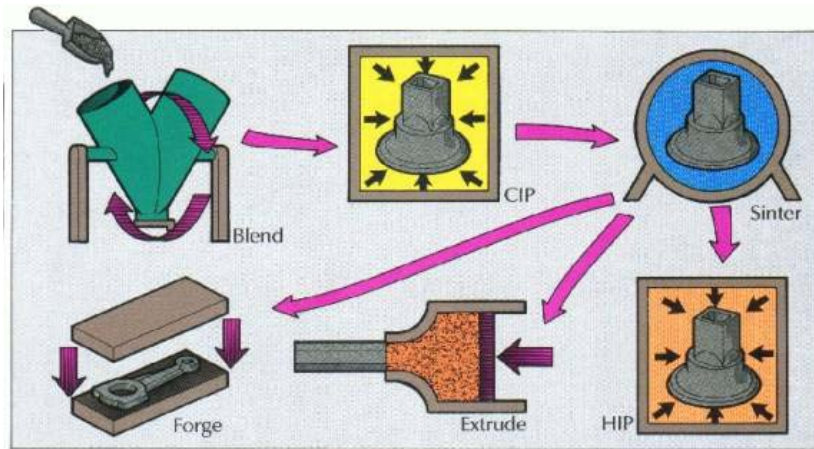

Fig. 18 The Dynamet CermeTi® Process  
(Courtesy of Dynamet Technology, Inc.)



Fig. 19. Parts made with CermeTi® Composite  
(Courtesy of Dynamet Technology, Inc.)

6.2.3 Powder Cold Spray; Sandia National Laboratory:<sup>33</sup> Figures 20 and 21 show a process imported from Russia which uses high pressure, supersonic flow of a cool (i.e.  $\sim 200^{\circ}\text{C}$ ) gas/powder mixture to impinge the powder onto a surface and create a  $>99\%$  dense metallic structure. No melting occurs, and the low temperature utilized maintains low oxygen content, preserves grain size and produces high-strength wrought material. It has been demonstrated on many metals including titanium. As-sprayed surfaces are reportedly smooth. Deposition efficiency is reported at  $>98\%$ , and feedstock and gasses should be recyclable. This process may have application as a “solid freeform” fabrication process, or as a method of producing sheet, perhaps combined with a finish rolling step. Deposition rate is  $\sim 10\text{-}20\text{ lb/h/nozzle}$ . Requires subsequent heat treat.

6.2.3.1 Remaining Concerns: Little development work has been done on this process with Ti, costs, process parameters and fundamentals are not well understood, and there are design optimization and possible nozzle fouling issues to be resolved.

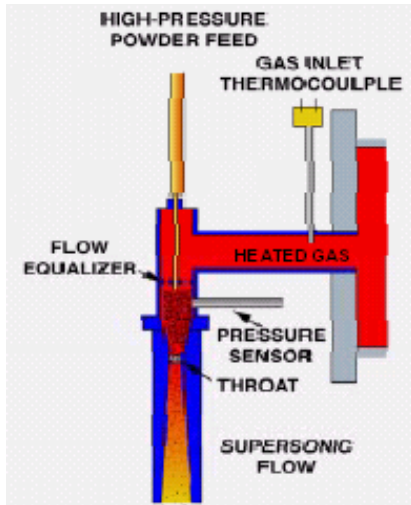

Fig. 20. Cold Spray Process  
(Courtesy Sandia Nat'l. Lab.)

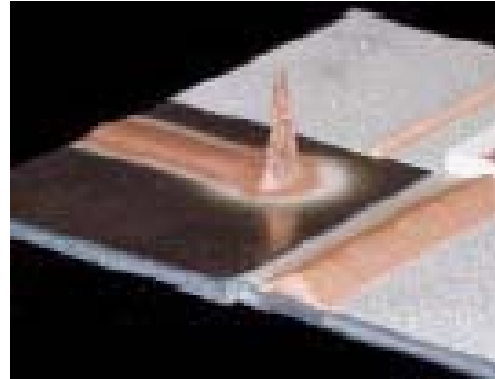

Fig. 21. Illustration of Copper Deposition  
(Courtesy Sandia Nat'l. Lab.)

6.2.4 Cold Compacted Mill Forms; DuPont Powder Metallurgy:<sup>34-36</sup> Both ADMA and Dynamet Technologies discussed above, and others, have practiced alloy powder metallurgy using pure Ti powder and master alloy addition powders, which form the desired alloy composition by diffusion during the sintering process. In the 1960's, DuPont Company developed a set of technologies around this principle, applying it to low cost forming of mill forms such as sheet, strip, plate, bar, tube and wire. They achieved properties in Ti-6Al-4V equivalent to that produced by the conventional vacuum remelting processes. At that time, however, economical Ti powders were not available. They also determined that in order to weld this Ti, chlorides need to be below about 50 ppm. Because low-cost and low-Cl powders were not available, DuPont abandoned the process. Perhaps the new low-cost sponge/powder processes discussed above will be able to yield product of sufficiently low Cl, and price to commercialize this route to mill forms of Ti.

6.2.4.1 Remaining Concerns: The Cl content and cost of the new powder processes need to be demonstrated. The previous success of DuPont in roll compaction of sheet, cold rolling and extrusion of mill forms, and production of forging pre-forms needs to be demonstrated with these powders.

### 6.3 Automotive Applications

Titanium products are used in the aerospace, industrial, architectural, medical, defense, consumer and automotive markets. Certainly the largest user has been the aerospace industry, whose demand is both cyclical and characterized by use of small numbers of very high value components. These factors have largely shaped the existing titanium industry. Component production may be characterized as "custom" or "job shop" in nature. The high cost of components has historically been absorbed by that industry, although efforts are made to find lower cost substitutes. For vehicular applications, however, production must be of high volume and low cost, whether for automotive or



heavy vehicle. In most discussions of Ti vehicular application, interest focuses on passenger car, van and light truck since those are viewed as attractive, high volume. With that focus, numerous niche applications have developed as listed in Table 13. Additional applications exist in the auto- and motorcycle-racing arenas, where performance is worth a high premium and life is short. Ti material and component suppliers have viewed these applications as a bridge between aerospace and other premium applications and automotive high volume. The intermediate volume heavy vehicle applications found and presented in this report may constitute a significant market in themselves, and also a more effective bridge to very high-volume applications.

6.3.1 TIMET Automotive: TIMET Metals Corporation claims to be the world’s largest supplier of high quality titanium metal products, and is the only remaining fully integrated producer in the USA. This includes being the only U.S. producer of titanium sponge, all of which they consume internally. To diversify their opportunities, they formed TIMET Automotive Division in January 2002. This group’s charter is to focus the Company’s resources that apply to this market, and to focus marketing efforts on introduction of new, high volume applications. The Company has had success in many of the niche application listed in Table 13. Figure 22 shows the automotive applications considered to be candidates for titanium. Their focus is mainly on Vehicle Classes 1-3, with the strongest emphasis on passenger car and other light vehicles. To strengthen

Table 13. Current and Recent Automotive Applications of Titanium Materials

| Vehicle                         | Application            | Original Alloy       | Ti Alloy              |
|---------------------------------|------------------------|----------------------|-----------------------|
| Corvette                        | Exhaust                | 409 SS               | TIMETAL Exhaust Grade |
| VW Lupo                         | Suspension Springs     | Cr-Si Steel          | TIMETAL LCB           |
| Porsche GT3                     | Connecting Rods        | Cr-Mo Steel          | Ti-6Al-4V             |
| Ferrari                         | Connecting Rods        | Cr-Mo Steel          | Ti-6Al-4V             |
| All Audi, VW                    | Sealing Washers        | Aluminum             | TIMETAL 35A           |
| All Mitsubishi 1.8L             | Valve Spring Retainers | Steel                | Beta alloy            |
| Toyota Alteza (Infinity IS 300) | Intake Valve           | 300 Series Stainless | Ti-6Al-4V             |
| Toyota Alteza (Infinity IS 300) | Exhaust Valve          | 300 Series Stainless | Ti-834+B              |
| Infinity Q45                    | Intake Valve           | 300 Series Stainless | Ti-6Al-4V             |
| Infinity Q45                    | Exhaust Valve          | 300 Series Stainless | Ti-834+B              |
| Mercedes S Class                | Brake Caliper Pin      | Stainless Steel      | CP Grade 2            |
| VW, Mercedes, BMW               | Wheel Rim Screws       | Alloy steel          | Ti-6Al-4V             |
| Yamaha, Suzuki, Kawasaki        | Muffler                | 409 SS               | TIMETAL Exhaust Grade |

(Courtesy TIMET Automotive)

this effort, they have developed several proprietary alloys designed for low cost and specific auto applications; examples are TIMETAL Exhaust Grade and TIMETAL LCB for springs. To reduce costs, they are attempting to transition production from the custom aerospace model to steel mill model volume oriented processing. The marketing effort includes integrating titanium at all levels of the supply chain.

6.3.1.1 Remaining Concerns: The strong TIMET automotive effort will definitely be of benefit to the heavy duty market. However, this focus on light vehicles may not solve some heavy-duty specific issues. One example is

the focus on coil springs, whereas heavy vehicles use leaf spring elements. TIMET is also not focused on the turbo rotor casting opportunity, although they are working with partners on the casting process. Also, while they have an independent activity on innovation in Ti reduction, they are pessimistic about the commercial potential of major breakthroughs.

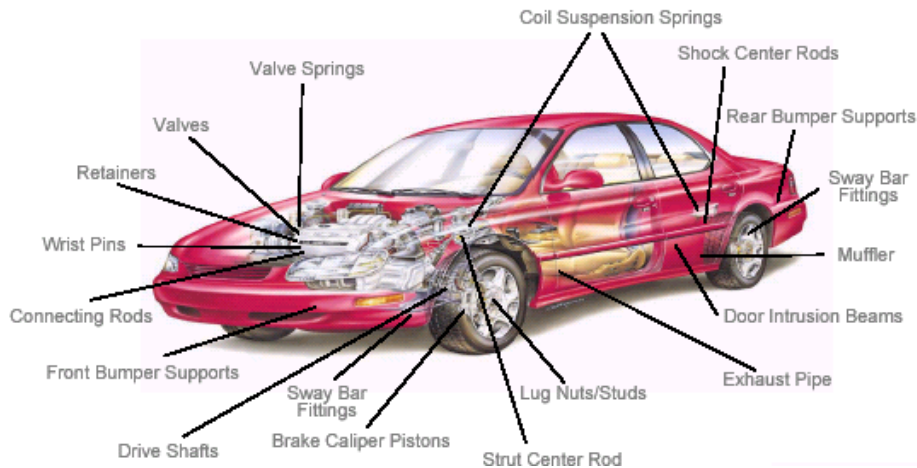

Fig. 22. Candidate Ti Applications Identified by TIMET Automotive Division  
(Courtesy TIMET Automotive)

#### 6.4 Other Government Efforts

While the present study is focused on heavy highway vehicle applications, other U.S. and foreign government efforts may provide good opportunity for collaboration.

6.4.1 U.S. Dept. of Defense: DOD has a Titanium Study Team which investigates the status and opportunities for Ti in defense systems. They have identified need for 5 – 10,000 tons/year of Ti primarily mill products (plate, sheet) and some other forms, but need significantly lower cost. They have also identified need for improvements and cost reduction in other forming processes, welding and machining. A solicitation has been issued by DARPA on process cost reduction.

6.4.2 Australian Commonwealth Scientific and Industrial Research Organization (CSIRO): Australia is a significant supplier of Ti bearing minerals. They wish to further develop their titanium industry. To accomplish this, they are targeting non-aerospace, high volume applications such as off shore, chemical processing, marine, consumer, sports and architecture. The effort will target a 50% reduction in sponge cost through exploring new reduction technologies and expanded use of lower cost raw materials such as Ilmenite. In downstream processing, they wish to achieve 30 – 50% reduction in mill products cost. To focus resources and coordinate efforts, CSIRO is establishing a Titanium Cooperative Research Center.<sup>37</sup>

## **7.0 References**

1. Sources: Ward's Communications; Automotive Market Research Council; Private Communications
2. Diesel Progress, N. Am. Ed., June 2000; [www.dieselpub.com](http://www.dieselpub.com); [www.dieselnet.com](http://www.dieselnet.com)
3. High Temperature, High Strength Nickel Base Alloys; International Nickel Co.; 1964
4. Materials Properties Handbook: Titanium Alloys; ASM International, 1994
5. CermeTi® – C Data Sheet; Dynamet Technology, Inc.
6. Metals Handbook, Vol.1:Properties and Selection: Irons, Steels and High Performance Alloys; ASM International, Metals Park, OH; 1990
7. Metals Handbook, Vol.2:Properties and Selection: Nonferrous Alloys and Special –Purpose Materials; ASM International, Metals Park, OH; 1990
8. [www.matweb.com](http://www.matweb.com)
9. <http://minerals.usgs.gov/minerals/pubs/commodity/titanium>
10. Proceedings, 11<sup>th</sup> Industrial Minerals International Congress, 1994, p.113; and, [www.dupont.com/tipure](http://www.dupont.com/tipure)
11. Private communication, DuPont
12. [www.metalbulletin.com](http://www.metalbulletin.com)
13. <http://minerals.usgs.gov/minerals/pubs/commodity/magnesium>
14. Calculated from data in: CRC Handbook of Chemistry and Physics, 64<sup>th</sup> Ed., 1983, CRC Press Inc., pp D50-93.
15. Private communication, Specialty Metals Co., Belgium
16. [www.sumitomocorp.co.jp/o-hitetsu/titanium](http://www.sumitomocorp.co.jp/o-hitetsu/titanium)
17. [www.zytp.com](http://www.zytp.com)
18. [www.bushveldalloys.co.uk](http://www.bushveldalloys.co.uk)
19. <http://minerals.usgs.gov/minerals/pubs/commodity/magnesium>
20. <http://minerals.usgs.gov/minerals/pubs/commodity/aluminum>
21. Direct electrochemical reduction of titanium dioxide to titanium in molten calcium chloride, G. Z. Chen, D. J. Fray, T. W. Farthing; Nature, **407**, 361-364 (Sept) 2000.
22. Report: The Role of Titanium in the Automobile: Understanding the Economic Implications of Two Emerging Technologies; Camanoe Assoc., Cambridge, MA; For Northwest Alliance for Transportation Technology; June 2001. Follow-on Study not yet published.
23. Titanium Process Technologies, S. J. Gerdemann; Advanced Materials and Processes, July 2001, p 41-43
24. Economics of Production of Primary Titanium by Electrolytic Winning, M. V. Ginatta; EPD Congress 2001, TMS, p 13-41
25. US Patent 6,074,545
26. Constructed by EHKTechnologies from observation of the ITP Process
27. Transference number measurements of TiO<sub>2</sub>-BaO melts by stepped-potential chronoamperometry, N. A. Fried, K. G. Rhoads, D. R. Sadoway; Electrochimica Acta 46 (2001) 3351-3358
28. <http://people.bu.edu/upal/plasma.html>
29. An Assessment of Existing Titanium Technologies, P. C. Turner, J. S. Hansen; Inter-Agency Titanium Research Committee – Minutes; Washington, DC; July 28, 1999
30. Private Communication; Santoku America, Inc., Phoenix, AZ
31. Private White Paper: Cost Effective Production of Powder Metallurgy Titanium Components, O. M. Ivasishin (IMP Ukraine), F. H. Froes (U. Idaho), V. S. Moxson (ADMA Products, OH)
32. [www.dynamettechnology.com](http://www.dynamettechnology.com)
33. [www.sandia.gov/coldspray](http://www.sandia.gov/coldspray)
34. DuPont Titanium Tonnage Powder Metallurgy; Appendix K; Titanium: Past, Present and Future; Publication NMAB-392, National Academy Press, Washington, DC, 1983.
35. US Patent 3,084,042; April 2, 1963
36. Us Patent 3,530,210; Sept. 22, 1970
37. Private Communication, CSIRO

## **8.0 Acknowledgements**

EHKTechnologies would like to thank all those who sponsored and participated in this project. The sponsorship of Dr. Sid Diamond of the U.S. Department of Energy and Dr. D. Ray Johnson of Oak Ridge National Laboratory provided funding under ORNL Subcontract 4000013062 and is greatly appreciated. Without the invaluable information, opinions and guidance of the following companies and organizations, this study and report would not have been possible:

|                                    |                                       |
|------------------------------------|---------------------------------------|
| ADMA Products, Inc.                | Mack Trucks, Inc.                     |
| AK Steel Corp.                     | Massachusetts Institute of Technology |
| Allvac, Inc.                       | Paccar, Inc.                          |
| ArvinMeritor, Inc.                 | Pacific Cast Technologies             |
| BorgWarner Turbo Systems           | PCC Structurals, Inc.                 |
| Boston University                  | QinetiQ Ltd.                          |
| British Titanium, plc              | Santoku America, Inc.                 |
| Camanoe Associates                 | Specialty Metals Co. SA               |
| Caterpillar, Inc.                  | Titanium Metals Corp.                 |
| Crucible Metals Corp.              | Titanium Products                     |
| Cummins Engine Company             | TRW, Inc.                             |
| Detroit Diesel Corp.               | UES, Inc.                             |
| Donaldson Company, Inc.            | University of Idaho                   |
| Drexel University                  | U.S. Air Force Materials Lab.         |
| Dynamet Technology, Inc.           | U.S. Army Research Lab.               |
| Eaton Corp.                        | U.S. DARPA                            |
| Fleetguard/Nelson Company          | U.S. Department of Energy             |
| Ford Motor Company                 | Albany Research Center                |
| Freightliner LLC                   | Oak Ridge National Laboratory         |
| Ginatta Torino Titanio s.r.l.      | Pacific Northwest National Lab.       |
| Heil Trailer International         | Sandia National Laboratory            |
| Hendrickson International          | US Naval Surface Warfare Center       |
| Howmet Research Corp.              | Volvo Trucks                          |
| International Titanium Powder      | Wabash National                       |
| International Truck & Engine Corp. |                                       |

For clarification or discussion, please contact:

Dr. Edwin H. Kraft  
EHKTechnologies  
10917 S.E. Burlington Drive  
Vancouver, WA 98664  
Phone: 360-896-0031  
Fax: 360-896-0032  
Email: [ekraft@ehktechnologies.com](mailto:ekraft@ehktechnologies.com)

### Final Report Distribution: Ti in Heavy Duty Vehicles

| Company                          | Names                                                     | Address                                                        | Phone                                        | Email                                                                                                                                                                                                              |
|----------------------------------|-----------------------------------------------------------|----------------------------------------------------------------|----------------------------------------------|--------------------------------------------------------------------------------------------------------------------------------------------------------------------------------------------------------------------|
| ADMA International, Inc.         | Vladimir S. Moxson                                        | 8189 Boyle Parkway<br>Twinsburg, OH 44087                      | 330-425-1230                                 |                                                                                                                                                                                                                    |
| Advanced Vehicle Systems, Inc.   | Rick Hitchcock                                            | 7801 Lee Highway<br>Chattanooga, TN 37421                      | 423-821-3146                                 | <a href="mailto:rhitchcock@bellsouth.net">rhitchcock@bellsouth.net</a>                                                                                                                                             |
| AK Steel Corporation             | Beth Knueppel                                             | 705 Curtis Street - Door #225<br>Middletown, OH 45043          | 513-727-5838                                 | <a href="mailto:beth.knueppel@aksteel.com">beth.knueppel@aksteel.com</a>                                                                                                                                           |
| Albany Research Center           | Paul C. Turner<br>Stephen J. Gerdemann<br>Alan D. Hartman | 1450 Queen Ave., SW<br>Albany, OR 97321                        | 541-967-5863<br>541-967-5964<br>541-967-5862 | <a href="mailto:turner@alrc.doe.gov">turner@alrc.doe.gov</a><br><a href="mailto:gerdemann@alrc.doe.gov">gerdemann@alrc.doe.gov</a><br><a href="mailto:Hartman@alrc.doe.gov">Hartman@alrc.doe.gov</a>               |
| Alcoa, Inc.                      | Russell Long<br>Todd Summe<br>David R. Williams           | 100 Technical Drive - Bldg D<br>Alcoa Center, PA 15069         | 724-337-5420<br>724-337-5464<br>724-337-2861 | <a href="mailto:Russell.long@alcoa.com">Russell.long@alcoa.com</a><br><a href="mailto:Todd.summe@alcoa.com">Todd.summe@alcoa.com</a><br><a href="mailto:David.r.Williams@alcoa.com">David.r.Williams@alcoa.com</a> |
| Allvac                           | Dick Kennedy                                              | P.O. Box 5030<br>2020 Ashcroft Ave.<br>Monroe, NC 28110        | 704-289-4511                                 | <a href="mailto:Dick.kennedy@allvac.com">Dick.kennedy@allvac.com</a>                                                                                                                                               |
| Aluminum Association             | Richard L. Klimisch                                       | One Towne Square<br>Suite 230<br>Southfield, MI 48076          | 248-784-3005                                 | <a href="mailto:rklimisc@aluminum.org">rklimisc@aluminum.org</a>                                                                                                                                                   |
| Aluminum Association             | Mike Skillingberg                                         | 00 19th Street, NW<br>Suite 300<br>Washington, D.C. 20006      | 202-862-5121                                 | <a href="mailto:mhskilli@aluminum.org">mhskilli@aluminum.org</a>                                                                                                                                                   |
| Aluminum Consultants Group, Inc. | Warren Hunt                                               | 4530 William Penn Highway, #3900<br>Murrysville, PA 15668-2002 | 724-733-1823                                 | -                                                                                                                                                                                                                  |
| American Iron and Steel Inst.    | (invitation already sent to Darryl Martin) Ron Krupitzer  | 2000 Town Center, Ste. 1900<br>Southfield, MI 48075-1138       | 248-351-2660                                 |                                                                                                                                                                                                                    |
| American Plastics Council        | Bruce T. Cundiff                                          | 1800 Crooks Road, Suite A<br>Troy, MI 48084                    | 248-244-8920                                 | <a href="mailto:bcundiff@ameriplas.org">bcundiff@ameriplas.org</a>                                                                                                                                                 |
| Ames Laboratory                  | Iver Anderson                                             | 126 Metals Dev<br>Ames, ID 50011-3020                          | 515-294-4446                                 | <a href="mailto:andersoni@ameslab.gov">andersoni@ameslab.gov</a>                                                                                                                                                   |

|                             |                                                                                            |                                                                                                      |                                                                              |                                                                                                                                                                                                                                                                                                                                                                        |
|-----------------------------|--------------------------------------------------------------------------------------------|------------------------------------------------------------------------------------------------------|------------------------------------------------------------------------------|------------------------------------------------------------------------------------------------------------------------------------------------------------------------------------------------------------------------------------------------------------------------------------------------------------------------------------------------------------------------|
| Argonne National Laboratory | William A. Ellingson<br>J. G. Sun<br>Jules Routbort<br>Linda Gaines<br>George Fenske       | 9700 South Cass Ave.,<br>ET/212<br>Argonne, IL 60439-4838                                            | 630-252-5068<br><br>630-252-5065<br>630-252-4919<br>630-252-5190             | <a href="mailto:ellingson@anl.gov">ellingson@anl.gov</a><br><a href="mailto:sun@anl.gov">sun@anl.gov</a><br><a href="mailto:routbort@anl.gov">routbort@anl.gov</a><br><a href="mailto:lgaines@anl.gov">lgaines@anl.gov</a><br><a href="mailto:gfenske@anl.gov">gfenske@anl.gov</a>                                                                                     |
| Auto/Steel Partnership      | Theodore Diewald                                                                           | 2000 Town Center - Suite<br>320 Southfield, MI<br>48075-1123                                         | 248-945-4776                                                                 | <a href="mailto:tdiewald@a-sp.org">tdiewald@a-sp.org</a>                                                                                                                                                                                                                                                                                                               |
| Autokinetics                | Bruce Emmons                                                                               | 1711 West Hamlin Road<br>Rochester Hills, MI 48309-<br>3368                                          | 248-852-4450                                                                 | <a href="mailto:jbemmons@autokinetics.com">jbemmons@autokinetics.com</a>                                                                                                                                                                                                                                                                                               |
| ArvinMeritor, Inc.          | Sam Ciray (“Category Leader”)<br>Cynthia Gosselin (Head, Matls. Lab.)                      | Columbus Technical Center<br>Materials Technology Lab,<br>Bldg.1, 950 W, 450 S<br>Columbus, IN 47201 | 812-341-2355<br>812-341-2340                                                 | <a href="mailto:sam.ciray@arvinmeritor.com">sam.ciray@arvinmeritor.com</a><br><a href="mailto:cynthia.gosselin@arvinmeritor.com">cynthia.gosselin@arvinmeritor.com</a>                                                                                                                                                                                                 |
| AVISMA                      | Vladislav Tetyukhin                                                                        | Berezniki, Perm Region<br>Zagorodnaya st., 1<br>618421, Russia                                       |                                                                              |                                                                                                                                                                                                                                                                                                                                                                        |
| Battelle                    | Jim Patton                                                                                 | 505 King Ave<br>Columbus, OH 43201                                                                   | 614-424-3792                                                                 |                                                                                                                                                                                                                                                                                                                                                                        |
| BIZTEK Consulting, Inc.     | Raymond Fessler                                                                            | 820 Roslyn Place<br>Evanston, IL 60201-1724                                                          | 847-733-7410                                                                 | <a href="mailto:BIZTEKrrf@aol.com">BIZTEKrrf@aol.com</a>                                                                                                                                                                                                                                                                                                               |
| BorgWarner Turbo Systems    | Robert Liebold                                                                             | PO Box 15075<br>Asheville, NC 28813                                                                  | 828-684-4002                                                                 | <a href="mailto:rliebold@turbos.bwauto.com">rliebold@turbos.bwauto.com</a>                                                                                                                                                                                                                                                                                             |
| Boston University           | Prof. Uday Pal                                                                             | Manufacturing Engineering<br>15 St. Mary’s St.<br>Boston, MA 02215                                   | 617-353-7708                                                                 | <a href="mailto:upal@bu.edu">upal@bu.edu</a>                                                                                                                                                                                                                                                                                                                           |
| British Titanium, plc       | James Hamilton (Chief Executive)                                                           | 37 Mossop St.<br>London SW3 2NB, England                                                             | 44 20 7589 8535                                                              | <a href="mailto:jah@britishtitanium.co.uk">jah@britishtitanium.co.uk</a>                                                                                                                                                                                                                                                                                               |
| Camanoe Assoc.              | Joel Clark<br>Randy Kirchain                                                               | Kendall Square<br>P.O. Box 425242<br>Cambridge, MA 02142                                             | 617-243-6885<br>617-253-4258                                                 | <a href="mailto:jpclark@mit.edu">jpclark@mit.edu</a>                                                                                                                                                                                                                                                                                                                   |
| Caterpillar, Inc.           | Michael Readey<br>Megan E. Frary<br>Mark J. Andrews<br>Lou Balmer-Millar<br>Brad Beardsley | Technical Center –E/854<br>PO Box 1875<br>Peoria, IL 61656-1875                                      | 309-578-6742<br>309-578-3366<br>309-578-2953<br>309-578-4468<br>309-578-2953 | <a href="mailto:Readey_Michael_J@cat.com">Readey_Michael_J@cat.com</a><br><a href="mailto:Frary_Megan_E@cat.com">Frary_Megan_E@cat.com</a><br><a href="mailto:Andrews_Mark_J@CAT.com">Andrews_Mark_J@CAT.com</a><br><a href="mailto:balmer-miller_lou@cat.com">balmer-miller_lou@cat.com</a><br><a href="mailto:Beardsley_M_Brad@cat.com">Beardsley_M_Brad@cat.com</a> |

|                               |                                                                    |                                                                          |                                              |                                                                                                                                                                                                                                                    |
|-------------------------------|--------------------------------------------------------------------|--------------------------------------------------------------------------|----------------------------------------------|----------------------------------------------------------------------------------------------------------------------------------------------------------------------------------------------------------------------------------------------------|
|                               | Greg Tomlins<br>Bill Lane<br>Karen Huber                           |                                                                          | 309-578-2958<br>309-578-8643<br>309-578-8106 | <a href="mailto:Tomlins_Gregory_W@cat.com">Tomlins_Gregory_W@cat.com</a><br><a href="mailto:Bill.lane@cat.com">Bill.lane@cat.com</a><br><a href="mailto:Huber_Karen_j@cat.com">Huber_Karen_j@cat.com</a>                                           |
| Composites Fabricators Assoc. | Larry Craigie                                                      | 655 N. Fort Myer Drive<br>Suite 510<br>Arlington, VA 22209               | (703) 525 0659                               | <a href="mailto:lcraigie@cfa-hq.org">lcraigie@cfa-hq.org</a>                                                                                                                                                                                       |
| Consultant                    | Ron Bradley                                                        | 4 Teal Wood Court<br>Hilton Head Island, SC<br>29926                     | 843-682-4166                                 | <a href="mailto:ronjo2001hhi@earthlink.net">ronjo2001hhi@earthlink.net</a>                                                                                                                                                                         |
| Consultant                    | Frank Ferfecki                                                     | 192 East Lincoln Street<br>Birmingham, MI 48009<br>(Hm)                  | (248) 645-0020                               | <a href="mailto:frank.ferfecki@owenscorning.com">frank.ferfecki@owenscorning.com</a>                                                                                                                                                               |
| Consultant                    | George Mayer                                                       | 1613 NW 191 st Street<br>Shoreline, WA 98177                             | 206-616-2832                                 | <a href="mailto:gmayer@u.washington.edu">gmayer@u.washington.edu</a>                                                                                                                                                                               |
| Consultant                    | Maxine Savitz                                                      | 10350 Wilshire Blvd., Apt.<br>604<br>Los Angeles, CA 90024               | 310-271-0874                                 | <a href="mailto:MaxineSavitz@aol.com">MaxineSavitz@aol.com</a>                                                                                                                                                                                     |
| Consultant                    | Michael Wheeler                                                    | 136 Bagot Street<br>Kingston, Ontario<br>K7L 3E5, Canada                 | 613-549-0266                                 | <a href="mailto:mike.wheeler2@sympatico.ca">mike.wheeler2@sympatico.ca</a>                                                                                                                                                                         |
| CSIRO                         | Dr. Richard Hannink<br>Dr. Raj Rajakumar                           | CSIRO Minerals<br>P O Box 312, Clayton<br>South, Vic 3169, Australia     | 61 3 9545 8625                               | <a href="mailto:Richard.Hannink@csiro.au">Richard.Hannink@csiro.au</a><br><a href="mailto:Raj.Rajakumar@csiro.au">Raj.Rajakumar@csiro.au</a>                                                                                                       |
| Cummins Inc.                  | Paul C. Becker<br>Randy Stafford<br>Tom Yonushonis<br>Martin Myers | Technical Center<br>MC 50183<br>1900 McKinley Ave.<br>Columbus, IN 47201 | 812-377-4701<br>812-377-3279<br>812-377-7078 | <a href="mailto:Paul.C.Becker@Cummins.com">Paul.C.Becker@Cummins.com</a><br><a href="mailto:randy.j.stafford@cummins.com">randy.j.stafford@cummins.com</a><br><a href="mailto:thomas.m.yonushonis@cummins.com">thomas.m.yonushonis@cummins.com</a> |
| Cymat Corp.                   | Richard Rusiniak                                                   | 1245 Aerowood Drive<br>Mississauga, Ontario L4W<br>1B9, Canada           | 905-602-1100<br>Ext. 10                      | <a href="mailto:rusiniak@cymat.com">rusiniak@cymat.com</a>                                                                                                                                                                                         |
| DaimlerChrysler Corporation   | Mary Neaton<br>Subi Dinda                                          | 800 Chrysler Drive<br>Auburn Hills, MI 48326-<br>2757                    | 248-576-6680                                 | <a href="mailto:Man14@daimlerchrysler.com">Man14@daimlerchrysler.com</a>                                                                                                                                                                           |
| DaimlerChrysler Corporation   | Thomas E. Turner                                                   | 7463 Orene St.<br>Shelby Twp., MI 48317                                  | 586-997-0132                                 | <a href="mailto:tet4@dcx.com">tet4@dcx.com</a>                                                                                                                                                                                                     |
| DANA Corporation              | Hong Lin<br>Fred Mahler                                            | 8000 Yankee Road<br>Ottawa Lake, MI 49267                                | 419-535-4377<br>419-535-4332                 | <a href="mailto:hong.lin@dana.com">hong.lin@dana.com</a>                                                                                                                                                                                           |

|                                                              |                                                               |                                                                                     |                                                                    |                                                                                                                                                                                                                                                                                                                                |
|--------------------------------------------------------------|---------------------------------------------------------------|-------------------------------------------------------------------------------------|--------------------------------------------------------------------|--------------------------------------------------------------------------------------------------------------------------------------------------------------------------------------------------------------------------------------------------------------------------------------------------------------------------------|
| Delphi Automotive Systems                                    | Jay Batten<br>David Witucki<br>Ashok Shah<br>Bradley Sizelove | 3900 E. Holland Road APC #1<br>Saginaw, MI 48601-9494                               | (989) 757-3895<br>(989) 757-4984<br>(989) 757-4988<br>989-757-3848 | <a href="mailto:jay.batten@delphiauto.com">jay.batten@delphiauto.com</a><br><a href="mailto:david.witucki@delphiauto.com">david.witucki@delphiauto.com</a><br><a href="mailto:ashok.shah@delphiauto.com">ashok.shah@delphiauto.com</a><br><a href="mailto:Bradley.sizelove@delphiauto.com">Bradley.sizelove@delphiauto.com</a> |
| Delphi Research Labs                                         | Michael Wyzgoski                                              | 51786 Shelby Parkway<br>Shelby Township, MI 48315                                   | 586-323-6655                                                       | <a href="mailto:michael.g.wyzgoski@delphiauto.com">michael.g.wyzgoski@delphiauto.com</a>                                                                                                                                                                                                                                       |
| Detroit Diesel Corp.                                         | Nabil S. Hakim<br>Yury Kalish<br>Craig Savignon               | Detroit Diesel Corp.<br>13400 Outer Drive, West<br>Detroit, MI 48239-4001           | 313-592-7455<br>313-592-7825                                       | <a href="mailto:nhakim01@detroitdiesel.com">nhakim01@detroitdiesel.com</a>                                                                                                                                                                                                                                                     |
| Donaldson Company, Inc. (Ail Filtration and Exhaust Systems) | Julian Imes<br>Ted Angelo                                     | Exhaust Div.; MS 208<br>POBox 1299<br>Minneapolis, MN 55440-1299                    | 952-887-3730<br>952-887-3832                                       | <a href="mailto:imes@mail.donaldson.com">imes@mail.donaldson.com</a><br><a href="mailto:tangelo@mail.donaldson.com">tangelo@mail.donaldson.com</a>                                                                                                                                                                             |
| Dynamet Technology, Inc.                                     | Stanley Abkowitz                                              | Eight A Street<br>Burlington, MA 01803                                              | 781-272-5967                                                       | <a href="mailto:sabkowitz@dynamettechnology.com">sabkowitz@dynamettechnology.com</a>                                                                                                                                                                                                                                           |
| Eaton Corp.                                                  | Jose Masello                                                  | Engine Air Management Operations<br>19218 B Drive South<br>Marshall, MI, 49068-8600 | 616-781-0346                                                       | <a href="mailto:josemasello@eaton.com">josemasello@eaton.com</a>                                                                                                                                                                                                                                                               |
| Ecoplexus Inc.                                               | Allan D. Murray                                               | 7217 Lindenmere Dr.,<br>Bloomfield MI 48301-3529                                    | 248-851-5377                                                       | <a href="mailto:ADMurray@peoplepc.com">ADMurray@peoplepc.com</a>                                                                                                                                                                                                                                                               |
| Edison Welding Institute                                     | Kevin Ely                                                     | 1250 Arthur E. Adams Drive<br>Columbus, OH 43221-3585                               | 614-688-5093                                                       | <a href="mailto:kevin_ely@ewi.org">kevin_ely@ewi.org</a>                                                                                                                                                                                                                                                                       |
| EHKTechnologies                                              | Edwin H. Kraft                                                | 10917 SE Burlington Drive<br>Vancouver, WA 98664-5383                               | 360-896-0031                                                       | <a href="mailto:ekraft@ehktechnologies.com">ekraft@ehktechnologies.com</a>                                                                                                                                                                                                                                                     |
| Fedex Ground                                                 | Bob Flesher                                                   | P.O. Box 108<br>Pittsburg, PA 15230                                                 | 412-262-6773                                                       | <a href="mailto:bob.flesher@fedex.com">bob.flesher@fedex.com</a>                                                                                                                                                                                                                                                               |
| Fleetguard, Inc.                                             | Ken Kicinski (Ch. Engr. Acoustic Prod.)                       | Nelson Division<br>PO Box 428<br>Stoughton, WI 53589                                | 608-873-4245                                                       |                                                                                                                                                                                                                                                                                                                                |
| Flex-N-Gate Corp.                                            | Ming Tang                                                     | 1306 E. University Ave.<br>Urbana, IL 61802                                         | 217-278-2323                                                       | <a href="mailto:mtang@flex-n-gate.com">mtang@flex-n-gate.com</a>                                                                                                                                                                                                                                                               |
| Ford Motor Company                                           | Andy Sherman                                                  | Ford Scientific Research                                                            | 313-594-6897                                                       | <a href="mailto:asherma1@ford.com">asherma1@ford.com</a>                                                                                                                                                                                                                                                                       |



|                                                                                           |                                                                                                                                                                 |                                                                                  |                                                                              |                                                                                                                                                                                                                                                                                                                                                                                    |
|-------------------------------------------------------------------------------------------|-----------------------------------------------------------------------------------------------------------------------------------------------------------------|----------------------------------------------------------------------------------|------------------------------------------------------------------------------|------------------------------------------------------------------------------------------------------------------------------------------------------------------------------------------------------------------------------------------------------------------------------------------------------------------------------------------------------------------------------------|
|                                                                                           | Bob Natkin                                                                                                                                                      | Lab<br>Mail Drop 3135<br>2101 Village Road<br>Dearborn, MI 48124                 | 313-322-1725                                                                 | <a href="mailto:rnatkin@ford.com">rnatkin@ford.com</a>                                                                                                                                                                                                                                                                                                                             |
| Ford Motor Company                                                                        | Paul Geck                                                                                                                                                       | Beech Daly Technical<br>Center<br>2001 Beech Daly Road<br>Dearborn Hts, MI 48125 | 313-323-0014                                                                 | <a href="mailto:pgeck@ford.com">pgeck@ford.com</a>                                                                                                                                                                                                                                                                                                                                 |
| Freightliner LLC                                                                          | Joseph S. Richie (Mktg.)<br>Darcy Shull (Mkt. Res.)<br>Dan Fuchs (Chassis Engg.)<br>Tony Petree (Body Engg.)<br>Luis Novoa                                      | 4747 N. Channel Ave.<br>PO Box 3849<br>Portland, OR 97208-3849                   | 503-745-5931<br>503-745-8322<br>503-745-6925<br>503-745-8687<br>503-745-8127 | <a href="mailto:JoeRichie@Freightliner.com">JoeRichie@Freightliner.com</a><br><a href="mailto:DarcyShull@Freightliner.com">DarcyShull@Freightliner.com</a><br><a href="mailto:DanFuchs@Freightliner.com">DanFuchs@Freightliner.com</a><br><a href="mailto:TonyPetree@Freightliner.com">TonyPetree@Freightliner.com</a><br><a href="mailto:novoala@attbi.com">novoala@attbi.com</a> |
| Ginatta Torino Titanio s.r.l.                                                             | Marco V. Ginatta                                                                                                                                                | Via Bologna 220<br>10154, Torino, Italy                                          | 39-011-240-7337                                                              | <a href="mailto:ginatta.titanio@tin.it">ginatta.titanio@tin.it</a>                                                                                                                                                                                                                                                                                                                 |
| Great Dane Trailers                                                                       | Dan McCormack<br>Charlie Fetz                                                                                                                                   | P.O. Box 67<br>Savannah, GA 31402                                                | 912-644-2414<br>912-644-2413                                                 | <a href="mailto:djmccormack@greatdanetrailers.com">djmccormack@greatdanetrailers.com</a>                                                                                                                                                                                                                                                                                           |
| Heil Trailer International                                                                | Travis McCloud (Ch. Engr-Liquid<br>Haul)<br>Brian Yielding (Ch. Engr-Dry Bulk)                                                                                  | PO Box 160<br>1125 Congress Parkway<br>Athens, TN 37303                          | 423-745-<br>5830X218<br>423-745-<br>5830X235                                 | <a href="mailto:tmcccloud@heiltrailer.com">tmcccloud@heiltrailer.com</a><br><a href="mailto:byielding@heiltrailer.com">byielding@heiltrailer.com</a>                                                                                                                                                                                                                               |
| Hendrickson International<br>(Suspension Systems;<br>largest leaf spring<br>manufacturer) | Bill Wilson<br>Ray Atchinson<br>Jeff Zawacki                                                                                                                    | 800 S. Frontage Rd.<br>Woodridge, IL 60517-4904                                  | 630-910-2840<br><br>630-910-2124                                             | <a href="mailto:bwilson@hendrickson-intl.com">bwilson@hendrickson-intl.com</a><br><br><a href="mailto:jzawacki@hendrickson-intl.com">jzawacki@hendrickson-intl.com</a>                                                                                                                                                                                                             |
| Hexel Carbon Fibers                                                                       | Mohamed Abdallah                                                                                                                                                | P.O. Box 18748<br>Salt Lake City, UT 84118-<br>0748                              | 801-508-8083                                                                 | <a href="mailto:mohamed.abdallah@hexcel.com">mohamed.abdallah@hexcel.com</a>                                                                                                                                                                                                                                                                                                       |
| Howmet Research Corp.                                                                     | Richard A. Thompson (Marketing<br>Mgr.)<br>Paul A. McQuay (Mgr., Adv. Aero<br>Matl)<br>Paul S. Follansbee (VP Technology)<br>Tom Wright (AF Casting Initiative) | 1500 S. Warner St.<br>Whitehall, MI 49461                                        | 231-894-7087<br>231-894-7250<br>231-894-7212<br>231-894-7519                 | <a href="mailto:rthompson@howmet.com">rthompson@howmet.com</a><br><a href="mailto:pmcquay@howmet.com">pmcquay@howmet.com</a><br><a href="mailto:pfollansbee@howmet.com">pfollansbee@howmet.com</a><br><a href="mailto:vsirotek@howmet.com">vsirotek@howmet.com</a>                                                                                                                 |
| Hydro Magnesium<br>Marketing                                                              | Darryl Albright                                                                                                                                                 | 21644 Melrose Avenue<br>Southfield, MI 48075-7905                                | 313-353-2629                                                                 | <a href="mailto:darryl.albright@hydro.com">darryl.albright@hydro.com</a>                                                                                                                                                                                                                                                                                                           |
| ICRC                                                                                      | Tom Watson                                                                                                                                                      | 1115 E. Whitcomb                                                                 | 248-823-4287                                                                 | <a href="mailto:twatson@icrc-detroit.net">twatson@icrc-detroit.net</a>                                                                                                                                                                                                                                                                                                             |

|                                       |                                              |                                                                                                          |                                              |                                                                                                                                                      |
|---------------------------------------|----------------------------------------------|----------------------------------------------------------------------------------------------------------|----------------------------------------------|------------------------------------------------------------------------------------------------------------------------------------------------------|
|                                       |                                              | Madison Heights, MI<br>48071                                                                             |                                              |                                                                                                                                                      |
| Idaho National Engineering Laboratory | Glenn Moore                                  | Bechtel BWXT Idaho<br>P.O. Box 1625, MS-2210<br>Idaho Falls, ID 83415                                    | 208-526-9587                                 | <a href="mailto:mga@inel.gov">mga@inel.gov</a>                                                                                                       |
| Institute for Defense Analysis        | Dr. Yevgeny Macheret                         | 4850 Mark Center Dr.<br>Alexandria, VA 22311-1882                                                        |                                              |                                                                                                                                                      |
| International Titanium Assoc.         |                                              | 350 Interlocken Blvd.<br>Suite 390<br>Broomfield, CO 80021-3485                                          | 303-404-2221                                 |                                                                                                                                                      |
| International Titanium Powder         | Richard P. Anderson<br>Grant Crowley         | 20634 W. Gaskin Dr.<br>Lockport, IL 60441                                                                | 815-834-2112                                 | <a href="mailto:richardanderson@itponline.com">richardanderson@itponline.com</a><br><a href="mailto:Crowley@itponline.com">Crowley@itponline.com</a> |
| International Truck & Engine Corp.    | Nirmal Tolani (Trucks)<br>V. K. Sharma       | Truck Development and<br>Technology Center<br>2911 Meyer Road<br>PO Box 1109<br>Ft. Wayne, IN 46803-1109 | 260-461-1238<br>260-461-1237                 | <a href="mailto:nirmal.tolani@nav-international.com">nirmal.tolani@nav-international.com</a>                                                         |
| International Truck & Engine Corp.    | Heinz Wamser (Engines)                       | 10400 W. North Ave.<br>Melrose Park, IL 60160                                                            | 708-865-4017                                 | <a href="mailto:heinz.wamser@nav-international.com">heinz.wamser@nav-international.com</a>                                                           |
| JB Hunt                               | Henry Pianalto                               | PO Box 690<br>Lowell, AR 72745                                                                           | 501-659-8620                                 |                                                                                                                                                      |
| Kenworth                              | James Bechtold                               | PO Box 1000<br>Kirkland, WA 98083-1000                                                                   | 425-828-5104                                 | <a href="mailto:jim.bechtold@paccar.com">jim.bechtold@paccar.com</a>                                                                                 |
| Kindrick Trucking Company, Inc.       | Gary Kindrick                                | Rt 8, Box 342<br>Harriman, TN 37748                                                                      | 423-882-0457                                 | <a href="mailto:gk@kindrickgroup.com">gk@kindrickgroup.com</a>                                                                                       |
| Los Alamos National Laboratory        | Ricardo Schwarz                              | Materials Science and<br>Tech. MailStop K765<br>Los Alamos, NM 87545                                     | 505-667-8454                                 | <a href="mailto:rxzs@lanl.gov">rxzs@lanl.gov</a>                                                                                                     |
| Mack Trucks, Inc. (Engines)           | John B. Bartel<br>Guy Rini                   | 13302 Pennsylvania Ave.<br>Hagerstown, MD 21742                                                          | 301-790-5762<br>301-790-5832                 | <a href="mailto:john.bartel@macktrucks.com">john.bartel@macktrucks.com</a><br><a href="mailto:guy.rini@macktrucks.com">guy.rini@macktrucks.com</a>   |
| Mack Trucks, Inc. (Trucks)            | Steve Ginter<br>Tom Davis<br>Mark Kachmarsky | Advanced Engineering<br>2402 Lehigh Parkway<br>South<br>Allentown, Pa. 18103                             | 610-709-3257<br>610-709-3655<br>610-351-8667 | <a href="mailto:Mark_kachmarsky@macktrucks.com">Mark_kachmarsky@macktrucks.com</a>                                                                   |

|                                                |                                                                                         |                                                                                                                       |                              |                                                                                                                        |
|------------------------------------------------|-----------------------------------------------------------------------------------------|-----------------------------------------------------------------------------------------------------------------------|------------------------------|------------------------------------------------------------------------------------------------------------------------|
| Magnesium Corp. of America                     | Howard Kaplan                                                                           | 238 North 2200 West<br>Salt Lake City, UT 84116                                                                       | 801-532-2043                 | <a href="mailto:hkaplan@magnesiumcorp.com">hkaplan@magnesiumcorp.com</a>                                               |
| Massachusetts Institute of Technology          | Prof. Donald R. Sadoway                                                                 | Department of Materials<br>Science and Engineering<br>Room 8-109<br>77 Massachusetts Ave.<br>Cambridge, MA 02139-4307 | 617-253-3487                 | <a href="mailto:dsadoway@mit.edu">dsadoway@mit.edu</a>                                                                 |
| Mayflower Vehicle Systems, Inc.                | Robert Fairchild                                                                        | 37900 Interchange Drive<br>Farmington Hills, MI<br>48335                                                              | 248-473-7500<br>ext. 503     | <a href="mailto:rob.fairchild@mvs-na.com">rob.fairchild@mvs-na.com</a>                                                 |
| Meridian Automotive Systems                    | Jeffrey Robbins                                                                         | 550 Town Center<br>Suite 450<br>Dearborn, MI 48126                                                                    | 313-253-4036                 | <a href="mailto:jrobbins@meridianautosystems.com">jrobbins@meridianautosystems.com</a>                                 |
| Meridian Automotive Systems                    | Ken Schmell                                                                             | 6701 Statesville Blvd<br>Salisbury, NC 28147                                                                          | 704-797-8744                 | <a href="mailto:kschmell@meridianautosystems.com">kschmell@meridianautosystems.com</a>                                 |
| National Composite Center                      | Scott Reeve                                                                             | 2000 Composite Drive<br>Kettering, OH 45420                                                                           | 937-297-9462                 | <a href="mailto:sreeve@compositecenter.org">sreeve@compositecenter.org</a>                                             |
| National Institute of Standards and Technology | Said Jahanmir, Metallurgy Div., Stop 8553<br>George Quinn, Ceramics Division, Stop 8521 | Gaithersburg, MD 20899                                                                                                | 301-975-3671<br>301-975-5765 | <a href="mailto:said.jahanmir@nist.gov">said.jahanmir@nist.gov</a><br><a href="mailto:geoq@nist.gov">geoq@nist.gov</a> |
| Noranda Inc.                                   | Mihriban Pekguleryuz                                                                    | 240 Hymus Boulevard<br>Pointe-Claire<br>Quebec, Canada H9R 1G5                                                        | 514-630-9339                 |                                                                                                                        |
| North Carolina A&T State University            | Jagannathan Sankar                                                                      | Dept. of Mechanical<br>Engineering<br>Greensboro, NC 27411                                                            | 336/256-1151<br>ext. 2282    | <a href="mailto:sankar@ncat.edu">sankar@ncat.edu</a>                                                                   |
| North Carolina State University                | Albert J. Shih                                                                          | Mechanical & Aerospace<br>Engr.<br>2217 Broughton Hall,<br>Box 7910<br>Raleigh, NC 27695                              | 919-515-5260                 | <a href="mailto:ajshih@eos.ncsu.edu">ajshih@eos.ncsu.edu</a>                                                           |

|                               |                                                                                                                                                                                                                                                                                                                                                                                                                                                                                                                                                                                    |                                                                                         |                                                                                                                                                                                                                                                                                                                                              |                                                                                                                                                                                                                                                                                                                                                                                                                                                                                                                                                                                                                                                                                                                                                                                                                                                                                                                                                                                                                                                                                                                                                                                                                                                                                                                |
|-------------------------------|------------------------------------------------------------------------------------------------------------------------------------------------------------------------------------------------------------------------------------------------------------------------------------------------------------------------------------------------------------------------------------------------------------------------------------------------------------------------------------------------------------------------------------------------------------------------------------|-----------------------------------------------------------------------------------------|----------------------------------------------------------------------------------------------------------------------------------------------------------------------------------------------------------------------------------------------------------------------------------------------------------------------------------------------|----------------------------------------------------------------------------------------------------------------------------------------------------------------------------------------------------------------------------------------------------------------------------------------------------------------------------------------------------------------------------------------------------------------------------------------------------------------------------------------------------------------------------------------------------------------------------------------------------------------------------------------------------------------------------------------------------------------------------------------------------------------------------------------------------------------------------------------------------------------------------------------------------------------------------------------------------------------------------------------------------------------------------------------------------------------------------------------------------------------------------------------------------------------------------------------------------------------------------------------------------------------------------------------------------------------|
| Oak Ridge National Laboratory | L. F. Allard, MS-6064<br>Pete Angelini, MS-6065<br>Tim Armstrong, MS-6084<br>P. F. Becher, MS-6068<br>P. J. Blau, MS-6063<br>D. A. Blom, MS-6064<br>M. K. Ferber, MS-6068<br>Ed Grostick, MS-6472<br>D. Ray Johnson, MS-6066<br>J. O. Kiggans, MS-6087<br>C. T. Liu, MS-6115<br>S. B. McSpadden, MS-6069<br>P. J. Maziasz, MS-6115<br>R. D. Ott, MS-6063<br>A. E. Pasto<br>V. K. Sikka, MS-6083<br>P. S. Sklad, MS-6065<br>D. P. Stinton, MS-6065<br>T. N. Tiegs, MS-6087<br>C. D. Warren, MS-6065<br>R. E. Ziegler, MS-6472<br>Central Research Library, MS-6191<br>OTIC, MS-6254 | P.O. Box 2008<br>Oak Ridge, TN 37831                                                    | 865-574-4981<br>865-574-4565<br>865-574-7996<br>865-574-5157<br>865-574-5377<br>865-241-4065<br>865-576-0818<br>865-946-1203<br>865-576-6832<br>865-574-8863<br>865-574-4459<br>865-574-5444<br>865-574-5082<br>865-574-5172<br>865-574-5123<br>865-574-5112<br>865-574-5069<br>865-574-4556<br>865-574-5173<br>865-574-9693<br>865-946-1204 | <a href="mailto:allardlfjr@ornl.gov">allardlfjr@ornl.gov</a><br><a href="mailto:angelinip@ornl.gov">angelinip@ornl.gov</a><br><a href="mailto:armstrongt@ornl.gov">armstrongt@ornl.gov</a><br><a href="mailto:becherpf@ornl.gov">becherpf@ornl.gov</a><br><a href="mailto:blaupj@ornl.gov">blaupj@ornl.gov</a><br><a href="mailto:blomda@ornl.gov">blomda@ornl.gov</a><br><a href="mailto:ferbermk@ornl.gov">ferbermk@ornl.gov</a><br><a href="mailto:grosticket@ornl.gov">grosticket@ornl.gov</a><br><a href="mailto:johnsondr@ornl.gov">johnsondr@ornl.gov</a><br><a href="mailto:kiggansjojr@ornl.gov">kiggansjojr@ornl.gov</a><br><a href="mailto:liuct@ornl.gov">liuct@ornl.gov</a><br><a href="mailto:menspaddensb@ornl.gov">menspaddensb@ornl.gov</a><br><a href="mailto:maziaszpj@ornl.gov">maziaszpj@ornl.gov</a><br><a href="mailto:ottr@ornl.gov">ottr@ornl.gov</a><br><a href="mailto:pastoae@ornl.gov">pastoae@ornl.gov</a><br><a href="mailto:sikkavk@ornl.gov">sikkavk@ornl.gov</a><br><a href="mailto:skladps@ornl.gov">skladps@ornl.gov</a><br><a href="mailto:stintondp@ornl.gov">stintondp@ornl.gov</a><br><a href="mailto:tiegstn@ornl.gov">tiegstn@ornl.gov</a><br><a href="mailto:warrencd@ornl.gov">warrencd@ornl.gov</a><br><a href="mailto:zieglerre@ornl.gov">zieglerre@ornl.gov</a> |
| Oak Ridge National Laboratory | Rayond Boeman                                                                                                                                                                                                                                                                                                                                                                                                                                                                                                                                                                      | 2366 Eaton Gate Road<br>Orion Township, MI 48360                                        | 865-576-0382<br>OR<br>248-452-0336<br>MI                                                                                                                                                                                                                                                                                                     | <a href="mailto:boemanrg@ornl.gov">boemanrg@ornl.gov</a>                                                                                                                                                                                                                                                                                                                                                                                                                                                                                                                                                                                                                                                                                                                                                                                                                                                                                                                                                                                                                                                                                                                                                                                                                                                       |
| Old Dominion Freight Lines    | Tom Newby                                                                                                                                                                                                                                                                                                                                                                                                                                                                                                                                                                          | Maintenance Department<br>500 Old Dominion Way<br>Thomasville, NC 27360                 | 336-822-5572                                                                                                                                                                                                                                                                                                                                 | <a href="mailto:Thomas.Newby@ODFL.com">Thomas.Newby@ODFL.com</a>                                                                                                                                                                                                                                                                                                                                                                                                                                                                                                                                                                                                                                                                                                                                                                                                                                                                                                                                                                                                                                                                                                                                                                                                                                               |
| Oshkosh Truck Corporation     | Robert M. Hathaway                                                                                                                                                                                                                                                                                                                                                                                                                                                                                                                                                                 | New Product Development<br>Center<br>370 West Waukau Avenue<br>Oshkosh, Wisconsin 54902 | 920-233-9347                                                                                                                                                                                                                                                                                                                                 | <a href="mailto:bhathaway@oshtruck.com">bhathaway@oshtruck.com</a>                                                                                                                                                                                                                                                                                                                                                                                                                                                                                                                                                                                                                                                                                                                                                                                                                                                                                                                                                                                                                                                                                                                                                                                                                                             |
| PACCAR                        | Jim Reichman<br>Richard Bergstrand                                                                                                                                                                                                                                                                                                                                                                                                                                                                                                                                                 | 777 106 <sup>th</sup> Ave.<br>Bellevue, WA 98004                                        | 425-468-7884                                                                                                                                                                                                                                                                                                                                 | <a href="mailto:JReishman@paccar.com">JReishman@paccar.com</a>                                                                                                                                                                                                                                                                                                                                                                                                                                                                                                                                                                                                                                                                                                                                                                                                                                                                                                                                                                                                                                                                                                                                                                                                                                                 |
| Pacific Cast Technologies     | Wade Stevens                                                                                                                                                                                                                                                                                                                                                                                                                                                                                                                                                                       | 150 Queen Ave., SW<br>PO Box 908                                                        | 541-926-7711                                                                                                                                                                                                                                                                                                                                 |                                                                                                                                                                                                                                                                                                                                                                                                                                                                                                                                                                                                                                                                                                                                                                                                                                                                                                                                                                                                                                                                                                                                                                                                                                                                                                                |

|                                                                                                             |                                                                                                           |                                                                                           |                                                              |                                                                                                                                                                                                                                                                                                                                |
|-------------------------------------------------------------------------------------------------------------|-----------------------------------------------------------------------------------------------------------|-------------------------------------------------------------------------------------------|--------------------------------------------------------------|--------------------------------------------------------------------------------------------------------------------------------------------------------------------------------------------------------------------------------------------------------------------------------------------------------------------------------|
|                                                                                                             |                                                                                                           | Albany, OR 97321                                                                          |                                                              |                                                                                                                                                                                                                                                                                                                                |
| Pacific Northwest National Laboratory                                                                       | Russell H. Jones<br>Moe Khaleel<br>Mark T. Smith<br>Darrell R. Herling<br>Richard W. Davies<br>Jud Virden | 902 Battelle Boulevard<br>PO Box 999<br>Richland, WA 99352                                | 509-376-4276<br>509-375-2438<br>509-376-2847<br>509-376-3892 | <a href="mailto:rh.jones@pnl.gov">rh.jones@pnl.gov</a><br><a href="mailto:moe.khaleel@pnl.gov">moe.khaleel@pnl.gov</a><br><a href="mailto:mark.smith@pnl.gov">mark.smith@pnl.gov</a><br><a href="mailto:darrell.herling@pnl.gov">darrell.herling@pnl.gov</a><br><br><a href="mailto:jud.virden@pnl.gov">jud.virden@pnl.gov</a> |
| PCC Structural, Inc.<br>(investment cast Ti rotors)                                                         | David Cribbs (Process Metallurgist)<br>Lee Kissinger (Marketing)<br>Brad Scott ( Engg Proj. Mgr.)         | Small Structural Business<br>Op.<br>4600 SE Harney Dr.<br>Portland, OR 97206-0898         | 503-652-4646<br>503-777-3881<br>503-777-3881                 | <a href="mailto:dcribbs@pcc-structurals.com">dcribbs@pcc-structurals.com</a>                                                                                                                                                                                                                                                   |
| Pechiney Aluminum                                                                                           | Paul Kobe                                                                                                 | PO Box 68 Century Road<br>Ravenswood, WV 26164                                            | 304-273-6466                                                 | <a href="mailto:paul.kobe@pechiney.com">paul.kobe@pechiney.com</a>                                                                                                                                                                                                                                                             |
| Peterbilt                                                                                                   | Landon Sproull                                                                                            | 3200 Airport Road<br>Denton, TX 76207                                                     | 940-566-7765                                                 | <a href="mailto:lsproull@paccar.com">lsproull@paccar.com</a>                                                                                                                                                                                                                                                                   |
| Profile Composites                                                                                          | Geoffrey Wood                                                                                             | 1416 Lands End Road<br>Sydney, BC V8L5K1                                                  | 250-655-7142                                                 | <a href="mailto:gmwood@aol.com">gmwood@aol.com</a>                                                                                                                                                                                                                                                                             |
| Purdue University                                                                                           | David R. Johnson                                                                                          | School of Materials<br>Engineering<br>1289 MSEE Building<br>West Lafayette, IN 47907-1289 | 765-494-7009                                                 | <a href="mailto:davidjoh@ecn.purdue.edu">davidjoh@ecn.purdue.edu</a>                                                                                                                                                                                                                                                           |
| QinetiQ Ltd.<br>(Original Licensee of<br>FFC-Cambridge Process,<br>and the “Research Arm” of<br>British Ti) | Prof. Malcolm Ward-Close                                                                                  | Cody Technology Park<br>Ively Road<br>Farnborough, Hampshire,<br>UK                       | 44 1252 392540                                               | <a href="mailto:mwardclose@qinitiq.com">mwardclose@qinitiq.com</a>                                                                                                                                                                                                                                                             |
| R&L Carriers                                                                                                | Jerry Johns                                                                                               | PO Box 271<br>Wilmington, OH 45177                                                        | 800-582-1485                                                 |                                                                                                                                                                                                                                                                                                                                |
| Reitnouer Inc.                                                                                              | Bud Reitnouer, President                                                                                  | 4001 Reading Crest Ave.<br>Reading, PA 19605                                              | 610-929-4856                                                 | <a href="mailto:dormae@early.com">dormae@early.com</a>                                                                                                                                                                                                                                                                         |
| Roadway                                                                                                     | Tom Parks                                                                                                 | 1077 Gorge Blvd<br>Akron, OH 44310                                                        | 330-384-1717                                                 |                                                                                                                                                                                                                                                                                                                                |
| Sandia National<br>Laboratories                                                                             | J. Bruce Kelley                                                                                           | P.O. Box 5800; MS 0753<br>Albuquerque, NM 87185-0753                                      | 505-845-3384                                                 | <a href="mailto:jbkelle@sandia.gov">jbkelle@sandia.gov</a>                                                                                                                                                                                                                                                                     |
| Sandia National<br>Laboratories                                                                             | Douglas Bammann                                                                                           | P.O. Box 5800; MS 9405<br>Albuquerque, NM 87185-                                          | 925-294-2585                                                 | <a href="mailto:bammann@sandia.gov">bammann@sandia.gov</a>                                                                                                                                                                                                                                                                     |

|                                           |                                       |                                                                                                                |                              |                                                                                                                                              |
|-------------------------------------------|---------------------------------------|----------------------------------------------------------------------------------------------------------------|------------------------------|----------------------------------------------------------------------------------------------------------------------------------------------|
|                                           |                                       | 9405                                                                                                           |                              |                                                                                                                                              |
| Santoku America, Inc.                     | Ranjan Ray                            | 8220 W. Harrison St.<br>Tolleson, AZ 85353                                                                     | 623-907-6122                 | <a href="mailto:r-ray@santoku.com">r-ray@santoku.com</a>                                                                                     |
| Southeastern Freight Lines                | Dave Foster                           | 4025 Sunset Blvd.<br>West Columbia, SC 29169                                                                   | 803-794-0047                 | <a href="mailto:dfoster@sefl.com">dfoster@sefl.com</a>                                                                                       |
| Southern Illinois University              | Dale Wittmer                          | Department of Mechanical<br>Engr. & Energy Processes<br>Carbondale, IL 62901                                   | 618-453-7006                 | <a href="mailto:wittmer@engr.siu.edu">wittmer@engr.siu.edu</a>                                                                               |
| Specialty Metals Co. SA                   | Sylvain Gehler                        | 42 A Rue Tenbosch<br>1050 Brussels, Belgium                                                                    | 32 2 645 76 11               | <a href="mailto:Sylvain.gehler@specialtymetals.be">Sylvain.gehler@specialtymetals.be</a>                                                     |
| TMC/ATA                                   | Robert Braswell                       | 2200 Mill Road<br>Alexandria, VA 22314                                                                         | 703-838-1776                 | <a href="mailto:rbraswel@trucking.org">rbraswel@trucking.org</a>                                                                             |
| Taratec Corporation                       | Ed Ungar                              | 1251 Dublin Road<br>Columbus, OH 43215                                                                         | 614-291-2229                 | <a href="mailto:eungar@tarateccorp.com">eungar@tarateccorp.com</a>                                                                           |
| Titanium Industries                       | Tom Deming                            | 181 E. Halsey Rd.<br>Parsippany, NJ 07054                                                                      | 973-428-7675                 | <a href="mailto:tdeming@titanium.com">tdeming@titanium.com</a>                                                                               |
| Titanium Metals Corp.<br>TiMet Automotive | Kurt Faller<br>Steven H. Reichman     | 900 Hemlock Rd.<br>Morgantown, PA 19543                                                                        | 610-286-1222<br>610-286-1200 | <a href="mailto:kurt.faller@timet.com">kurt.faller@timet.com</a><br><a href="mailto:steven.reichman@timet.com">steven.reichman@timet.com</a> |
| Titanium Products                         | Larry LaVoy                           | P.O. Box 2580<br>Waldport, OR 97394                                                                            | 541-867-3769                 |                                                                                                                                              |
| Tower Automotive                          | Mohib Durrani<br>Christopher Santucci | 3533 North 27th Street<br>Milwaukee, WI 53216                                                                  | 414-447-5833                 | <a href="mailto:durrani.mohib@towerautomotive.com">durrani.mohib@towerautomotive.com</a>                                                     |
| Tribo Materials<br>Technology, LLC (TMT)  | Yngve Naerheim                        | 1577 Kirk Avenue<br>Thousand Oaks, CA 91360                                                                    | 805-496-8371                 | <a href="mailto:ynaerheim@tmtlc.com">ynaerheim@tmtlc.com</a>                                                                                 |
| Truck Manufacturers<br>Assoc              | Bill Leasure                          | 1225 New York Ave NW<br>Washington, DC 20005                                                                   | 202-638-7825                 | <a href="mailto:tma_bill@ix.netcom.com">tma_bill@ix.netcom.com</a>                                                                           |
| UES, Inc.                                 | Tai-Il Mah                            | 4401 Dayton-Xenia Rd.<br>Dayton, OH 45432-1894                                                                 | 937-255-9829                 | <a href="mailto:Tai.mah@afri.af.mil">Tai.mah@afri.af.mil</a>                                                                                 |
| University of Colorado                    | Alan W. Weimer                        | Dept. of Chemical<br>Engineering<br>Engineering Center ECCH<br>118<br>Campus Box 424<br>Boulder, CO 80309-0424 | 303-492-3759                 | <a href="mailto:alan.weimer@colorado.edu">alan.weimer@colorado.edu</a>                                                                       |
| University of Idaho                       | Prof. F. H. (Sam) Froes               | Institute for Materials and<br>Advanced Processes<br>Mines Building                                            | 208-885-7989                 | <a href="mailto:imap@uidaho.edu">imap@uidaho.edu</a><br><a href="mailto:deloresc@uidaho.edu">deloresc@uidaho.edu</a>                         |

|                               |                                                                                                                                                                                                                                            |                                                                                                                  |                                                                                                                                              |                                                                                                                                                                                                                                                                                                                                                                                                                                                                                                                                                                                                                                                                        |
|-------------------------------|--------------------------------------------------------------------------------------------------------------------------------------------------------------------------------------------------------------------------------------------|------------------------------------------------------------------------------------------------------------------|----------------------------------------------------------------------------------------------------------------------------------------------|------------------------------------------------------------------------------------------------------------------------------------------------------------------------------------------------------------------------------------------------------------------------------------------------------------------------------------------------------------------------------------------------------------------------------------------------------------------------------------------------------------------------------------------------------------------------------------------------------------------------------------------------------------------------|
|                               |                                                                                                                                                                                                                                            | Room 321<br>Moscow, ID 83844-3026                                                                                |                                                                                                                                              |                                                                                                                                                                                                                                                                                                                                                                                                                                                                                                                                                                                                                                                                        |
| University of Virginia        | Prof. Phillip A. Parrish                                                                                                                                                                                                                   | Materials Sci. &<br>Engineering<br>Thornton Hall, B120<br>P. O. Box 400745<br>Charlottesville, VA 22904-<br>4745 | 434-924-1087                                                                                                                                 | <a href="mailto:Pap4n@virginia.edu">Pap4n@virginia.edu</a>                                                                                                                                                                                                                                                                                                                                                                                                                                                                                                                                                                                                             |
| US Air Force Materials<br>Lab | Rollie Dutton                                                                                                                                                                                                                              | AFRL/MLLM, Bldg 655<br>2230 Tenth St, Suite 1<br>Wright-Patterson AFB, OH<br>45433-7817                          | 937-255-9834                                                                                                                                 | <a href="mailto:rollie.dutton@wpafb.af.mil">rollie.dutton@wpafb.af.mil</a>                                                                                                                                                                                                                                                                                                                                                                                                                                                                                                                                                                                             |
| US Army ARDEC                 | Stephen Luchowski                                                                                                                                                                                                                          | AMSTA-AR-WEA<br>Bldg. 355<br>Picatinny Arsenal, NJ<br>07806                                                      |                                                                                                                                              |                                                                                                                                                                                                                                                                                                                                                                                                                                                                                                                                                                                                                                                                        |
| US Army Research Lab          | William de Rosset                                                                                                                                                                                                                          | Dir. ARL<br>Attn: AMSRL-WM-MD<br>(William de Rosset)<br>APG, MD 21005                                            | 410-306-0816                                                                                                                                 | <a href="mailto:derosset@arl.army.mil">derosset@arl.army.mil</a>                                                                                                                                                                                                                                                                                                                                                                                                                                                                                                                                                                                                       |
| US Army Research Lab          | Dr. Joe Wells                                                                                                                                                                                                                              | AMSRL-WM-MC<br>Bldg 4600/MS N208<br>APG, MD 21005-5069<br>Aberdeen, MD                                           | 410-306-0752                                                                                                                                 | <a href="mailto:jwells@arl.army.mil">jwells@arl.army.mil</a>                                                                                                                                                                                                                                                                                                                                                                                                                                                                                                                                                                                                           |
| USATACOM                      | Don Ostberg, MS-255<br>Jamie Florence, MS-232<br>Scott Hodges, MS-257<br>Chip Filar, MS-256                                                                                                                                                | AMSTA-TR-D<br>6501 E. 11 Mile Rd.<br>Warren, MI 48397-5000                                                       | 586-574-8718<br>586-574-5755                                                                                                                 | <a href="mailto:OstbergD@tacom.army.mil">OstbergD@tacom.army.mil</a><br><a href="mailto:florencej@tacom.army.mil">florencej@tacom.army.mil</a><br><a href="mailto:hodgess@tacom.army.mil">hodgess@tacom.army.mil</a><br><a href="mailto:filarc@tacom.army.mil">filarc@tacom.army.mil</a>                                                                                                                                                                                                                                                                                                                                                                               |
| US DARPA                      | Dr. Leo Christodoulou                                                                                                                                                                                                                      | DARPA/DSO<br>3701 N. Fairfax Dr.<br>Arlington, VA 22203-1714                                                     | 703-696-2374                                                                                                                                 | <a href="mailto:lchristodoulou@darpa.mil">lchristodoulou@darpa.mil</a>                                                                                                                                                                                                                                                                                                                                                                                                                                                                                                                                                                                                 |
| US Dept. of Energy            | Robert S. Kirk, EE-2G<br>Thomas J. Gross, EE-11<br>Joseph A. Carpenter, EE-2G<br>Sidney Diamond, EE-2G<br>James J. Eberhardt, EE-2G<br>Pat Flaherty, EE-2G<br>Rogelio Sullivan, EE-2G<br>Kenneth C. Howden, EE-2G<br>Gurpreet Singh, EE-2G | 1000 Independence Ave.,<br>S.W.<br>Washington, DC 20585                                                          | 202-586-8055<br>202-586-8027<br>202-586-1022<br>202-586-8032<br>202-586-9827<br>202-586-6794<br>202-586-8042<br>202-586-3631<br>202-586-2333 | <a href="mailto:Robert.kirk@ee.doe.gov">Robert.kirk@ee.doe.gov</a><br><a href="mailto:Tom.gross@ee.doe.gov">Tom.gross@ee.doe.gov</a><br><a href="mailto:Joseph.carpenter@ee.doe.gov">Joseph.carpenter@ee.doe.gov</a><br><a href="mailto:Sid.diamond@ee.doe.gov">Sid.diamond@ee.doe.gov</a><br><a href="mailto:James.eberhardt@ee.doe.gov">James.eberhardt@ee.doe.gov</a><br><a href="mailto:PAFlaherty@aol.com">PAFlaherty@aol.com</a><br><a href="mailto:Rogelio.Sullivan@ee.doe.gov">Rogelio.Sullivan@ee.doe.gov</a><br><a href="mailto:Ken.howden@ee.doe.gov">Ken.howden@ee.doe.gov</a><br><a href="mailto:Gurpreet.singh@ee.doe.gov">Gurpreet.singh@ee.doe.gov</a> |

|                                                        |                                              |                                                                                            |                                              |                                                                                                                                                                                                                    |
|--------------------------------------------------------|----------------------------------------------|--------------------------------------------------------------------------------------------|----------------------------------------------|--------------------------------------------------------------------------------------------------------------------------------------------------------------------------------------------------------------------|
| US Dept. of Transportation                             | Bob Clark                                    | 400 7 <sup>th</sup> Street, NW<br>Washington, DC 20590                                     | 202-366-6167                                 |                                                                                                                                                                                                                    |
| US Geological Survey                                   | Joseph Gambogi                               | 983 National Center<br>Reston, VA 20192                                                    | 703-648-7718                                 | <a href="mailto:jgambogi@usgs.gov">jgambogi@usgs.gov</a>                                                                                                                                                           |
| US National Aeronautics<br>and<br>Space Administration | Dennis L. Dicus                              | Mail Stop 188A<br>2 West Reid Street<br>NASA Langley Res. Center<br>Hampton, VA 23681-2199 | 757-864-3137                                 |                                                                                                                                                                                                                    |
| US Naval Sea Systems<br>Command                        | William A. Palko                             | NSWC Carderock Division<br>9500 MacArthur Blvd.<br>West Bethesda, MD 20817                 | 301-227-4968                                 | <a href="mailto:palkoWA@nswccd.navy.mil">palkoWA@nswccd.navy.mil</a>                                                                                                                                               |
| US Naval Surface Warfare<br>Center                     | Bill Messick                                 | NSWC Carderock Division<br>9500 MacArthur Blvd.<br>West Bethesda, MD 20817                 | 301-227-4811                                 | <a href="mailto:messickwt@nswccd.navy.mil">messickwt@nswccd.navy.mil</a>                                                                                                                                           |
| Valtimet, Inc.                                         | Wendy McGowan                                | 5501 Air Park Blvd.<br>Morristown, TN 37813                                                | 423-585-4235                                 | <a href="mailto:Wendy.McGowan@valtimet.com">Wendy.McGowan@valtimet.com</a>                                                                                                                                         |
| VES Incorporated                                       | Al Lesesky                                   | P.O. Box 10880<br>Rock Hill, SC 29731                                                      | 803-366-7170                                 |                                                                                                                                                                                                                    |
| Visteon Automotive<br>Systems                          | Nick Gianaris                                | 6100 Mercury Drive<br>SW61-020 Dearborn, MI<br>48126                                       | 313 755-4706                                 |                                                                                                                                                                                                                    |
| Volvo Trucks North<br>America                          | Greg Gentle<br>Stefan Jansson<br>Skip Yeakel | TC1/35<br>P.O. Box 26115<br>Greensboro, NC 27402-<br>6115                                  | 336-393-3058<br>336-393-3622<br>336-393-2825 | <a href="mailto:Greg.gentle@volvo.com">Greg.gentle@volvo.com</a><br><a href="mailto:Stefan.b.jansson@volvo.com">Stefan.b.jansson@volvo.com</a><br><a href="mailto:Skip.yeakel@volvo.com">Skip.yeakel@volvo.com</a> |
| Wabash National<br>(also Fruehauf) (trailers)          | Rod Ehrlich<br>Frank Smidler                 | PO Box 6129<br>Lafayette, IN 47903                                                         | 765-771-5300<br>765-771-5440                 | <a href="mailto:rod.ehrlich@wabashnational.com">rod.ehrlich@wabashnational.com</a><br><a href="mailto:fsmidler@wabashnational.com">fsmidler@wabashnational.com</a>                                                 |
| West Virginia University                               | Jacky Prucz                                  | Mechanical & Aerospace<br>Dept<br>P.O Box 6106<br>Morgantown, WV 26506-<br>6106            | 304-293-3111<br>ext. 2314                    | <a href="mailto:jcprucz@mail.wvu.edu">jcprucz@mail.wvu.edu</a>                                                                                                                                                     |
| West Virginia University                               | Samir Shoukry                                | 517 Engineering Sciences<br>Bldg.<br>Morgantown, WV 26505                                  | 304-293-3111<br>Ext. 2367                    | <a href="mailto:Samir.Shoukry@mail.wvu.edu">Samir.Shoukry@mail.wvu.edu</a>                                                                                                                                         |
| XTRA Lease                                             | John Sullivan                                | XTRA Lease<br>1801 Park 270 Drive<br>Suite 400<br>St. Louis, MO 63146                      | 314-579-9300                                 |                                                                                                                                                                                                                    |



|        |                 |                                                             |              |                                                            |
|--------|-----------------|-------------------------------------------------------------|--------------|------------------------------------------------------------|
| Zoltek | Phillip Johnson | 3594 Vineyard Springs<br>Court<br>Rochester Hills, MI 48306 | 248-276-2418 | <a href="mailto:PJohn10007@aol.com">PJohn10007@aol.com</a> |
|--------|-----------------|-------------------------------------------------------------|--------------|------------------------------------------------------------|