



ORNL/TM-13315

**OAK RIDGE
NATIONAL
LABORATORY**



Validation of SCALE (SAS2H) Isotopic Predictions for BWR Spent Fuel

**O. W. Hermann
M. D. DeHart**

MANAGED AND OPERATED BY
LOCKHEED MARTIN ENERGY RESEARCH CORPORATION
FOR THE UNITED STATES
DEPARTMENT OF ENERGY

ORNL-27 (3-96)

This report has been reproduced directly from the best available copy.

Available to DOE and DOE contractors from the Office of Scientific and Technical Information, P.O. Box 62, Oak Ridge, TN 37831; prices available from (615) 576-8401.

Available to the public from the National Technical Information Service, U.S. Department of Commerce, 5285 Port Royal Rd., Springfield, VA 22161.

This report was prepared as an account of work sponsored by an agency of the United States Government. Neither the United States nor any agency thereof, nor any of their employees, makes any warranty, express or implied, or assumes any legal liability or responsibility for the accuracy, completeness, or usefulness of any information, apparatus, product, or process disclosed, or represents that its use would not infringe privately owned rights. Reference herein to any specific commercial product, process, or service by trade name, trademark, manufacturer, or otherwise, does not necessarily constitute or imply its endorsement, recommendation, or favoring by the United States Government or any agency thereof. The views and opinions of authors expressed herein do not necessarily state or reflect those of the United States Government or any agency thereof.

Computational Physics and Engineering Division

**VALIDATION OF SCALE (SAS2H) ISOTOPIC
PREDICTIONS FOR BWR SPENT FUEL**

O. W. Hermann and M. D. DeHart

Date Published: September 1998

Prepared by the
OAK RIDGE NATIONAL LABORATORY
managed by
LOCKHEED MARTIN ENERGY RESEARCH CORP.
for the
U.S. DEPARTMENT OF ENERGY
under contract DE-AC05-96OR22464

CONTENTS

	<u>Page</u>
LIST OF FIGURES	v
LIST OF TABLES	vii
ABSTRACT	xi
1. INTRODUCTION	1
2. BWR FUEL ASSEMBLY DATA FOR DEPLETION ANALYSES	3
2.1 COOPER BWR SPENT FUEL DESIGN AND OPERATION DATA	5
2.2 GUNDREMMINGEN BWR SPENT FUEL DESIGN AND OPERATING DATA ..	10
2.3 JPDR SPENT FUEL DESIGN AND OPERATING DATA	14
3. PREDICTED AND MEASURED ISOTOPIC COMPOSITIONS	23
3.1 COOPER BWR ISOTOPIC RESULTS	23
3.2 GUNDREMMINGEN BWR ISOTOPIC RESULTS	27
3.3 JPDR ISOTOPIC RESULTS	27
3.4 SUMMARY OF ISOTOPIC COMPARISON RESULTS	36
4. SUMMARY	41
5. REFERENCES	43
APPENDIX A – DESCRIPTION OF THE SCALE SAS2H DEPLETION APPROACH	47
A.1 References	51
APPENDIX B– INPUT LISTINGS FOR COOPER BWR SAS2H DEPLETION CALCULATIONS	53
APPENDIX C – INPUT LISTINGS FOR GUNDREMMINGEN BWR SAS2H DEPLETION CALCULATIONS	63
APPENDIX D – INPUT LISTINGS FOR JPDR BWR SAS2H DEPLETION CALCULATIONS	77
APPENDIX E – MEASURED AND COMPUTED ISOTOPIC CONCENTRATIONS FOR COOPER BWR FUEL SAMPLES	105

	<u>Page</u>
APPENDIX F – MEASURED AND COMPUTED ISOTOPIC CONCENTRATIONS FOR GUNDREMMINGEN BWR FUEL SAMPLES	109
APPENDIX G – MEASURED AND COMPUTED ISOTOPIC CONCENTRATIONS FOR JPDR BWR FUEL SAMPLES	113
APPENDIX H – SENSITIVITY OF CALCULATED CONCENTRATIONS TO ASSUMED MODERATOR DENSITY	121

LIST OF FIGURES

<u>Figure</u>	<u>Page</u>
1. Location of different type fuel rods in Assembly CZ346 of Cooper BWR.	7
2. Loading diagram of Assembly CZ346 showing fuel rods analyzed.	7
3. Locations of fuel rods analyzed in Assembly B23 of Gundremmingen BWR.	12
4. Locations of fuel rods analyzed in Assembly C16 of Gundremmingen BWR.	12
5. Locations of fuel rods analyzed in Assembly A-20 of JPDR.	16
6. Percentage differences between measured and calculated results for Cooper fuel samples.	26
7. Percentage differences between measured and calculated results for Gundremmingen fuel samples	30
8. Percentage differences between measured and calculated results for JPDR fuel samples.	35
9. Percentage differences between measured and calculated results for all fuel samples.	38
10. Standard deviation of isotopic prediction results by reactor type	39
A.1. Flow path invoked in SAS2H depletion and decay sequences.	49

LIST OF TABLES

<u>Table</u>	<u>Page</u>
1. Basic parameters of the measured spent fuel	4
2. Design and temperature data for Cooper BWR fuel assemblies	6
3. Initial uranium composition of Cooper BWR fuel samples	8
4. Operating data for Cooper BWR Assembly CZ346 and fuel pellet samples	9
5. Effective geometry for Cooper assembly model	10
6. Design and temperature data for Gundremmingen BWR fuel assemblies	11
7. Initial uranium composition of Gundremmingen BWR fuel samples	13
8. Operating data for Gundremmingen BWR Assemblies B23 and C16 and fuel pellet samples	13
9. Effective geometry for Gundremmingen assembly model	14
10. Design and temperature data for JPDR fuel assemblies	15
11. Initial uranium composition of JPDR fuel samples	17
12. Operating data for JPDR fuel samples from Assemblies A-14, A-18, and A-20 and total assembly data	18
13. Example of power history applied in SAS2H depletion model of Assembly A-14, node 2	19
14. Exposure uptimes and downtimes of power history in ORIGEN-S depletion model	20
15. Effective geometry for JPDR assembly model	21
16. Measured irradiation composition, in g/g UO ₂ , of Cooper BWR fuel	24
17. Measured irradiation composition, in Ci/g UO ₂ , of Cooper BWR fuel	24

	<u>Page</u>
18. Percentage difference between measured and computed nuclide compositions for Cooper BWR samples and averages from Assembly CZ346	25
19. Average measured irradiation composition of Gundremmingen BWR fuel	28
20. Percentage difference between measured and computed nuclide compositions for Gundremmingen BWR samples and averages from Assemblies B23 and C16	29
21. Measured irradiation composition of JPDR spent fuel from eight samples	31
22. Measured irradiation composition of JPDR spent fuel from eight additional samples ...	32
23. Percentage difference between measured and computed nuclide composition for JPDR samples and averages from Assemblies A-14, A-18, and A-20	33
24. Summary of percentage differences between measured and computed composition in this BWR validation study as averages and spreads	36
A.1. Nuclides updated by SAS2H	49
A.2. Element contents from clad, structure, and moderator for a generic BWR	51
H.1. Sensitivity of predicted concentrations to moderator density for a low-average-density Cooper fuel sample	123
H.2. Sensitivity of predicted concentrations to moderator density for a high-average-density Cooper fuel sample	124
H.3. Sensitivity of predicted concentrations to moderator density for a low-average-density Gundremmingen fuel sample	125
H.4. Sensitivity of predicted concentrations to moderator density for a high-average-density Gundremmingen fuel sample	126
H.5. Sensitivity of predicted-to-measured ratios to moderator density for a low-average-density Cooper fuel sample	127
H.6. Sensitivity of predicted-to-measured ratios to moderator density for a high-average-density Cooper fuel sample	128

	<u>Page</u>
H.7. Sensitivity of predicted-to-measured ratios to moderator density for a low-average-density Gundremmingen fuel sample	129
H.8. Sensitivity of predicted-to-measured ratios to moderator density for a high-average-density Gundremmingen fuel sample	130

ABSTRACT

Thirty spent fuel samples obtained from boiling-water-reactor (BWR) fuel pins have been modeled at Oak Ridge National Laboratory using the SAS2H sequence of the SCALE code system. The SAS2H sequence uses transport methods combined with the depletion and decay capabilities of the ORIGEN-S code to estimate the isotopic composition of fuel as a function of its burnup history. Results of these calculations are compared with chemical assay measurements of spent fuel inventories for each sample. Results show reasonable agreement between measured and predicted isotopic concentrations for important actinides; however, little data are available for most fission products considered to be important for spent fuel concerns (e.g., burnup credit, shielding, source-term calculations, etc.).

This work is a follow-up to earlier works that studied the ability to predict spent fuel compositions in pressurized-water-reactor (PWR) fuel pins. Biases and uncertainties associated with BWR isotopic predictions are found to be larger than those of PWR calculations. Such behavior is expected, as the operation of a BWR is significantly more complex than that of a PWR plant, and in general the design of a BWR has a more heterogeneous configuration than that of a PWR. Nevertheless, this work shows that the simple models employed using SAS2H to represent such complexities result in agreement to within 5% (and often less than 1%) or less for most nuclides important for spent fuel applications. On the other hand, however, the set of fuel samples analyzed represent a small subset of the BWR fuel population, and results reported herein may not be representative of the full population of BWR spent fuel.

1. INTRODUCTION

Accurate prediction of the isotopic composition of light-water-reactor (LWR) spent fuel is essential in the design, licensing, and operation of radioactive waste transportation systems, interim storage, and a permanent repository. An accurate determination of the time-dependent isotopic concentrations in spent fuel is required in evaluating (1) neutron multiplication for criticality safety, (2) neutron and gamma-ray source terms for shielding analyses, (3) decay-heat source terms for safety regarding temperature or heat transfer, and (4) radiological and chemical toxicity terms for environmental considerations. One of the functions of the SCALE (Standardized Computer Analyses for Licensing Evaluation) code system¹ is the capability to predict the isotopic composition of LWR spent fuel. Recent applications of nuclide depletion and production computations for LWR fuel include criticality safety analyses for investigation of storage or shipment of spent fuel.²⁻⁵ The ANSI/ANS-8.1 criticality standard⁶ requires the validation of the analytical methods used in these spent fuel criticality analyses. The purpose of this report is to describe efforts to validate the capability of the SCALE system, Version 4.3, to predict the isotopic composition of boiling-water-reactor (BWR) spent fuel. Complementary reports⁷⁻⁹ describe similar efforts to validate the use of the SCALE depletion analysis for the prediction of nuclide inventory of pressurized-water-reactor (PWR) spent fuel.

The 30 fuel samples analyzed in this study were taken from six separate fuel assemblies of three different BWRs: the Cooper Nuclear Power Plant (USA), the Gundremmingen Nuclear Power Plant (Germany), and the Japan Power Demonstration Reactor (JPDR). Radiochemical analyses¹⁰ of six Cooper fuel samples were conducted by the Material Characteristics Center (MCC) at Pacific Northwest Laboratory (PNL). The eight Gundremmingen fuel samples included in this work were analyzed by the European Joint Research Center (EJRC) at both the Ispra (Italy) and Karlsruhe (Germany) facilities.^{11,12} Sixteen fuel samples from the JPDR were selected and were analyzed by the Japanese Atomic Energy Research Institute (JAERI).¹¹ Even though not representative of most modern commercial BWR fuel designs and operating conditions, these data represent the majority of published and readily available BWR fuel assay data.

The major parameters characterizing the fuels analyzed in this project cover a relatively wide range. The fuel burnups extend from 2.16 to 33.94 GWd/MTU. The initial fuel enrichments of the samples vary from 2.53 to 2.94 wt % ^{235}U . The BWR designs include both 6×6 and 7×7 assembly lattices, and the active fuel lengths vary from 146.6 to 370.8 cm. The sample fuel pellets were burned with specific powers ranging from 3.74 to 25.34 MW/MTU, and were selected from a range of axial positions in the fuel such that average moderator densities ranged from 0.31 to 0.77 g/cm³.

The calculated (predicted) isotopic concentrations reported herein were produced by the SAS2H control module in Version 4.3 of the SCALE code system.¹ This control module produces burnup-dependent cross sections using the one-dimensional (1-D) neutronics model processing in SCALE and the fuel-depletion analysis of the ORIGEN-S code. Details of the procedure are described in Appendix A.

The cross-section library applied in these analyses was the SCALE 44-group library, produced from Evaluated Nuclear Data Files (ENDF).¹³ The 44-group library¹⁴ was derived from ENDF/B-V data, with the exception of three nuclides. The cross sections for ^{16}O , ^{154}Eu , and ^{155}Eu in this library were obtained from ENDF/B-VI files. The ENDF/B-VI files provided data with a significant change to resonance region cross sections for ^{154}Eu and ^{155}Eu (ref. 15). The newer ^{154}Eu evaluation results in better estimates of source terms for shielding calculations. The revised ^{155}Eu evaluation provides a better estimate of post-shutdown ^{155}Gd buildup from ^{155}Eu decay. The ^{16}O change involved improvements in the scattering kernel and is insignificant in the analyses described in this report.

The remainder of this report is divided into three sections: Sect. 2 furnishes a detailed description of the SAS2H fuel assembly models used to represent each fuel sample studied. In Sect. 3, results of comparisons of the predicted and measured isotopic composition are presented. Finally, the significance and limitations of these analyses are discussed in Sect. 4, together with recommendations for future work.

2. BWR FUEL ASSEMBLY DATA FOR DEPLETION ANALYSES

The 30 spent fuel cases selected as a basis for the SCALE-4.3 depletion analyses in this validation study were selected from radioactive assay data for spent fuel samples from the Cooper, Gundremmingen, and JPDR BWRs. The primary parameters that characterize spent fuel samples are initial ^{235}U enrichment, accumulated burnup, axial location or height, and moderator density at the fuel sample height. Table 1 summarizes the values of each of these parameters for the six samples from the Cooper BWR, the eight samples from two Gundremmingen assemblies, and the 16 fuel pellets from three assemblies of the JPDR. Although certainly not all-inclusive, these parameters bound operational parameters for a large fraction of BWR spent fuel. The low-to-reasonably-high burnups of the samples are considered to be adequate for statistical evaluation. Note, however, that the design of the fuel assemblies is generally atypical of the population of BWR fuel designs (e.g., the assemblies used axially uniform fuel enrichments, both Cooper and JPDR used uniform fuel loadings across the assembly, none of the fuel assemblies had water holes, and all were operated differently than most modern BWR fuel assemblies).

Because of several significantly different design and operational aspects of a BWR relative to PWR designs, other core parameters must be considered in BWR assembly models that have not been necessary in PWR models. Specifically, BWR models must accommodate assembly cross-plane (x-y) nonuniformities, control rod insertion, and moderator density variations due to assembly flow channels.

The coolant density at the axial height of the pellet sample is a required input parameter for the depletion calculation. However, the explicit coolant density data required for the calculation are seldom available in the open literature. In order to be consistent within this validation study, a method for estimating the coolant density was developed that applies design and operating parameters that were included in each set of data. Essentially, a correlation between power and moderator density as a function of height was developed. Water densities assumed for each axial location, calculated using this method, are listed in Table 1 for each fuel sample.

Table 1. Basic parameters of the measured spent fuel

No.	Unit name	Test assembly (pin No.)	Initial enrichment (wt % ²³⁵ U)	Axial level or node No.	Axial height ^a (cm)	Burnup (GWd/MTU)	Moderator density (g/cm ³)			
1	Cooper	CZ346(B3)	2.939	Cut B	351.7	18.96	0.3446			
2				Cut K	186.9	33.07	0.4705			
3				Cut T	131.0	33.94	0.5736			
4		CZ346(C3)		Cut B	350.1	17.84	0.3452			
5				Cut J	290.7	29.23	0.3723			
6				Cut U	114.7	31.04	0.6124			
7	Gundremmingen	B23(A1)	2.530	Low	44.0	25.73	0.7378			
8				High	268.0	27.40	0.3145			
9		B23(B3)		High	268.0	21.24	0.3145			
10		B23(E3)		High	268.0	23.51	0.3145			
11		Gundremmingen		C16(A1)	2.530	Low	44.0	20.30	0.7460	
12	High		268.0			19.85	0.3849			
13	C16(B3)		High			268.0	14.39	0.3849		
14		C16(E5)		High	268.0	17.49	0.3849			
15				JPDR	A-14 ^b	2.596	2	129.6	3.30	0.6075
16							9	44.0	4.04	0.7541
17	JPDR	A-18 ^b	2.596	2	129.6	2.71	0.5629			
18				6	80.7	4.25	0.6708			
19	JPDR	A-20(A1)	2.596	3	117.4	7.01	0.6719			
20		A-20(A3)		10	31.8	6.15	0.7642			
21		A-20(A6)		3	117.4	6.95	0.6719			
22				9	44.0	6.51	0.7600			
23		A-20(C3)		1	141.8	2.65	0.5232			
24				3	117.4	5.09	0.5688			
25				5	92.9	6.08	0.6276			
26				8	56.2	6.04	0.7305			
27				10	31.8	5.06	0.7534			
28				12	7.3	2.16	0.7701			
29		A-20(E2)		3	117.4	5.60	0.5688			
30				10	31.8	5.38	0.7534			

^a Height of sample above bottom of fuel.

^b Pin identified only as one of rods in the center part of assembly.

Although BWR designs tend to be more inhomogeneous and asymmetric than PWR designs, the 1-D XSDRNPM assembly model used for transport solutions and cross-section weighting, combined with the point depletion approach of ORIGEN-S (based on an assembly-averaged model), requires geometric simplifications and assumptions similar to those applied in PWR depletion modeling. Each fuel assembly was therefore modeled as a set of concentric rings, using engineering judgement in representing key features of the specific assembly design. Special treatment of control rod insertion is also necessary to properly account for system reactivity. Partial (usually small) control rod insertion is common in BWRs, especially early in a fuel cycle. Unfortunately, rod-positioning data are rarely available in documentation of fuel- assay data, nor is SAS2H designed to explicitly model partial control rod insertion. In an earlier validation effort for BWR decay heat estimates,¹⁶ a procedure was developed where an assembly-averaged model was set up, and boron was added to the moderator material at a concentration such that the average of all values of k_{eff} calculated for each cycle was close to unity. Hence the soluble boron was in effect matching the reactivity of control rod insertion in maintaining a critical system. This approach was used in the Gundremmigen analyses, but was not deemed necessary for the other reactor fuel assemblies.

The approximations made to represent absorber rods and general assembly design characteristics varied for each assembly type and are detailed in the following subsections, which describe the specific attributes of each assembly design. Other design-specific modeling assumptions or approximations are also detailed for each assembly design.

2.1 COOPER BWR SPENT FUEL DESIGN AND OPERATION DATA

The Cooper Nuclear Power Plant, operated by the Nebraska Public Power District, used General Electric BWR fuel assemblies with a 7×7 pin lattice for the fuel cycles analyzed in this report. The fuel rod lattice data and other fuel assembly design and operating characteristics, obtained from refs. 10 and 16–19, are listed in Table 2. A fuel bundle map and a partial loading diagram of assembly CZ346 are shown in Figs. 1 and 2, respectively. Three sample pellets from each of two rods were used in the radiochemical analyses.

Table 2. Design and temperature data for Cooper BWR fuel assemblies

Parameter	Data
Assembly general data	
Designer	General Electric
Lattice, version	7 × 7, GE-3b
Equivalent core diameter, cm (in.)	402(158)
Number of fuel rods	49
Number with 2.939 wt % ²³⁵ U	30
Number with 1.94 wt % ²³⁵ U	12
Number with 1.69 wt % ²³⁵ U	6
Number with 1.33 wt % ²³⁵ U	1
Number of rods containing Gd	5
Number with 3.0 wt % Gd ₂ O ₃	3
Number with 4.0 wt % Gd ₂ O ₃	2
Channel tube thickness, cm (in.)	0.20(0.08)
Assembly pitch, cm (in.)	15.24(6.0)
Coolant inlet temperature, K	546 ^a
Coolant average temperature, K	558 ^b
Channel temperature, K	552 ^b
Channel tube material	Zircaloy-4
Channel tube temperature, K	558 ^b
Assembly fuel, kg U	190.71 ^c
Fuel rod data	
Type fuel pellet	UO ₂
Hot pellet density, ^d g/cm ³	9.73
Rod pitch, cm (in.)	1.875(0.738)
Rod OD, cm (in.)	1.430(0.563)
Rod ID, cm (in.)	1.242(0.489)
Hot pellet diameter, cm (in.)	1.242(0.489)
Active fuel length, cm (in.)	370.84(146)
Effective fuel temperature, K	840 ^b
Clad temperature, K	620 ^b
Clad material	Zircaloy-2

^aObtained using a linear extrapolation of the average and maximum inlet temperatures in generic BWR data from ref. 19.

^bFuel, coolant, and clad temperatures were not available in the literature. Temperatures given in generic BWR data from refs. 16 and 19 were applied.

^cComputed from other data in this table.

^dAssumed 1% dishing of pellet. Applied hot fuel diameter equal to rod ID.

Sources: Refs. 10, 16–19.

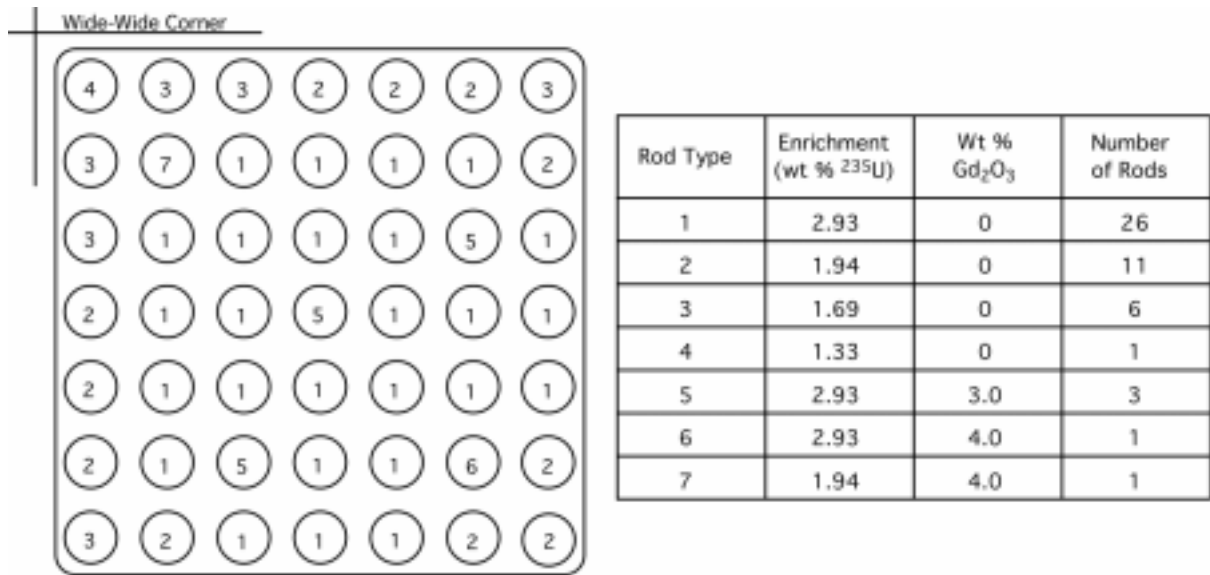

Fig. 1. Location of different type fuel rods in Assembly CZ346 of Cooper BWR.

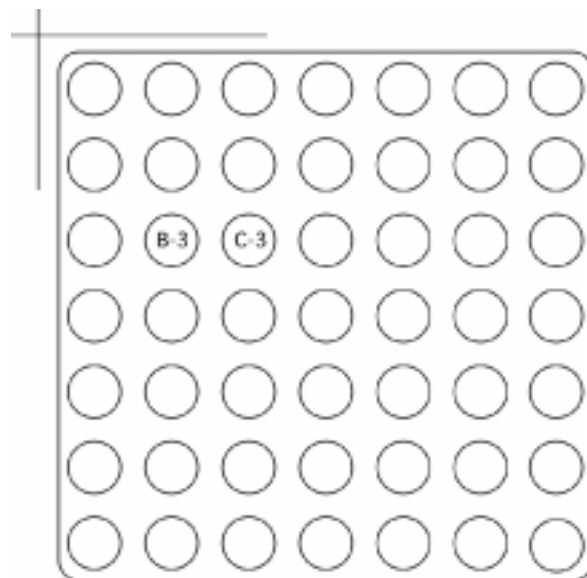

Fig. 2. Loading diagram of Assembly CZ346 showing fuel rods analyzed.

The initial uranium isotopic composition of the sample fuel rods is listed in Table 3. The initial weight fraction of ^{235}U was obtained from ref. 10; the fractions of the remaining uranium isotopes were estimated from the wt % ^{235}U value by empirical relationships developed in earlier ion validation work.¹⁶ Although the Cooper design (like most BWR fuel assemblies) contained multiple enrichments, the depletion calculational procedure in the SAS2H control module does not accommodate more than a single initial composition. Therefore, it was also assumed that the assembly contained a uniform loading corresponding to the enrichment of the sample pin. Although this approximation may not produce accurate assembly-averaged flux spectra, the depletion solution is primarily driven by initial conditions. Hence to estimate the time-dependent composition of a specific fuel sample, it is imperative to begin calculations with the correct initial composition of that sample.

Table 3. Initial uranium composition of Cooper BWR fuel samples

Uranium isotope	Assembly CZ346, rods at B3 and C3 (wt %)
^{235}U	2.939
^{234}U	0.026
^{236}U	0.014
^{238}U	97.021

The operating histories of Assembly CZ346¹⁰ and each fuel sample are shown in Table 4. Reference data provided cumulative burnup per cycle of the assembly and the estimated final burnup of each sample. Cycle burnups for each sample were estimated assuming each sample was burned at the same relative rate as the full assembly. Thus pin burnups per cycle were obtained by normalizing the assembly burnup history and multiplying by the final sample burnup. The cycle-averaged power in each pin was then obtained by dividing the pin burnup by the cycle length for each cycle. The values in Table 4 are not meant to indicate a precision of three significant digits for burnups; they simply indicate the number of digits retained in local burnup estimates.

Table 4. Operating data for Cooper BWR Assembly CZ346 and fuel pellet samples

Cycle No.	1	2	3	6	7
Startup date	7/4/74	11/16/76	10/18/77	6/8/80	6/8/81
Shutdown date	9/17/76	9/17/77	3/31/78	4/20/81	5/21/82
Cycle length, d	806	306	165	317	347
Downtime, d	60	31	800	49	0
Assembly burnup, GWd/MTU					
Cumulative	13.90	19.14	21.92	25.20	28.05
Increment/cycle	13.90	5.24	2.78	3.28	2.85
Cycle burnup, GWd/MTU					
Rod ADD2966(B3), 351.7 cm	9.396	3.542	1.879	2.217	1.926
Rod ADD2966(B3), 186.9 cm	16.388	6.178	3.278	3.867	3.360
Rod ADD2966(B3), 131.0 cm	16.819	6.34	3.364	3.969	3.448
Rod ADD2974(C3), 350.1 cm	8.840	3.333	1.768	2.086	1.813
Rod ADD2574(C3), 290.7 cm	14.485	5.460	2.897	3.418	2.970
Rod ADD2974(C3), 114.7 cm	15.382	5.799	3.076	3.630	3.154
Cycle average power, MW/MTUO ₂					
Assembly CZ346 (full)	17.246	17.124	16.848	10.347	8.213
Rod ADD2966(B3), 351.7 cm	10.275	10.203	10.039	6.165	4.894
Rod ADD2966(B3), 186.9 cm	17.922	17.796	17.509	10.753	8.535
Rod ADD2966(B3), 131.0 cm	18.394	18.264	17.970	11.036	8.760
Rod ADD2974(C3), 350.1 cm	9.668	9.600	9.446	5.801	4.605
Rod ADD2974(C3), 290.7 cm	15.841	15.729	15.476	9.504	7.544
Rod ADD2974(C3), 114.7 cm	16.822	16.703	16.435	10.093	8.011

Source: Ref. 10.

A model of the full assembly CZ346 was developed to determine the soluble boron concentration necessary to create a system operated at a k_{eff} value near unity. An average moderator density of 0.5151 g/cm³ and an average assembly enrichment of 2.5086 wt % were derived from available data. The specific powers listed in Table 4 for the full assembly were applied. The resulting calculations showed that k_{eff} was sufficiently close to unity (within a few percent); thus, a soluble boron addition was not deemed necessary for Cooper models.

The assembly unit cell model used in Path B of SAS2H applied an average Gd₂O₃-UO₂ fuel pin at the center of the model. One-fifth of the assembly and associated channel were used per cell because there were five gadolinium rods in the assembly design. Applying one-fifth of the cross-sectional area of all materials of the assembly and channel, the zone radii of the assembly model were determined, as listed in Table 5. SAS2H case inputs for the Cooper BWR models are provided in Appendix B.

Table 5. Effective geometry for Cooper assembly model

Radial zone	Material	Radius, cm
1	Gd ₂ O ₃ -UO ₂ fuel	0.621
2	Clad of fuel rod	0.715
3	Moderator outside Gd rod in unit cell	1.058
4	Homogenized fuel, clad and moderator (of Path A)	3.311
5	Channel tube	3.412
6	Moderator outside of channel tube	3.845

2.2 GUNDREMMINGEN BWR SPENT FUEL DESIGN AND OPERATING DATA

The Gundremmingen Nuclear Power Plant, operated by Kenkraftwerk RWE-Bayernwerk GmbH (KRB), uses fuel assemblies with a 6 × 6 lattice. Data characterizing the assembly design and operating conditions for the Gundremmingen BWR^{11,12,16} are listed in Table 6. Assembly loading diagrams, depicting the selected sample rods for Assemblies B23 and C16, are shown in Figs. 3 and 4, respectively. Four sample pellets from each of two assemblies were used in this study.

The initial ²³⁵U enrichment¹¹ and the calculated¹⁶ concentrations of the other uranium isotopes are listed in Table 7. Operating power history data for the Assemblies B23 and C16 are given in Table 8. The cycle powers shown in the table for each sample were derived by a procedure similar to that used for the Cooper BWR power histories.

A full-assembly model of Assembly B23, using a volume-weighted moderator density of 0.5378 g/cm³, the average enrichment of 2.402 wt % ²³⁵U and the power history for the B23 burnup, was used to estimate the ¹⁰B concentration of the channel moderator that would produce an average k_{eff} of approximately unity. A ¹⁰B concentration of 4×10^{-5} atoms/barn-cm (860 ppm ¹⁰B) was

Table 6. Design and temperature data for Gundremmingen BWR fuel assemblies

Parameter	Data
Assembly general data	
Lattice	6 × 6
Equivalent core diameter, cm (in.)	274.8 (108.2)
Number of fuel rods	36
Number with 2.53 wt % ²³⁵ U	29
Number with 1.87 wt % ²³⁵ U	7
Channel tube thickness, cm (in.)	0.15(0.059)
Outer tube flat-to-flat, cm (in.)	11.352(4.469)
Assembly pitch, cm (in.)	13.098(5.157)
Coolant inlet temperature, K	539
Coolant average temperature, K	549
Channel temperature, K	539
Channel tube material	Zircaloy-4
Channel tube temperature, K	549
Assembly (dished) fuel, kg UO ₂ (kg U)	144 (126.93)
Fuel rod data	
Type fuel pellet	UO ₂
Hot pellet density, g/cm ³	
Assembly B23 (undished ^a)	10.068
Assembly C16 (dished ^b)	9.866 ^c
Rod pitch, cm (in.)	1.780(0.7008)
Rod OD, cm (in.)	1.428(0.5622)
Rod ID, cm (in.)	1.250(0.4922)
Hot pellet diameter, cm (in.)	1.250(0.4922)
Active fuel length, cm (in.)	330.2(130.0)
Effective fuel temperature, K	923
Clad temperature, K	620 ^d
Clad material	Zircaloy-2

^aReported as “undished.”

^bReported as “dished.” It is approximately 2% dishing.

^cComputed from fuel mass and volume dimensions listed in this table.

^dClad temperature given in generic BWR data from ref. 19 was applied.

Sources: Refs. 11, 12, and 19.

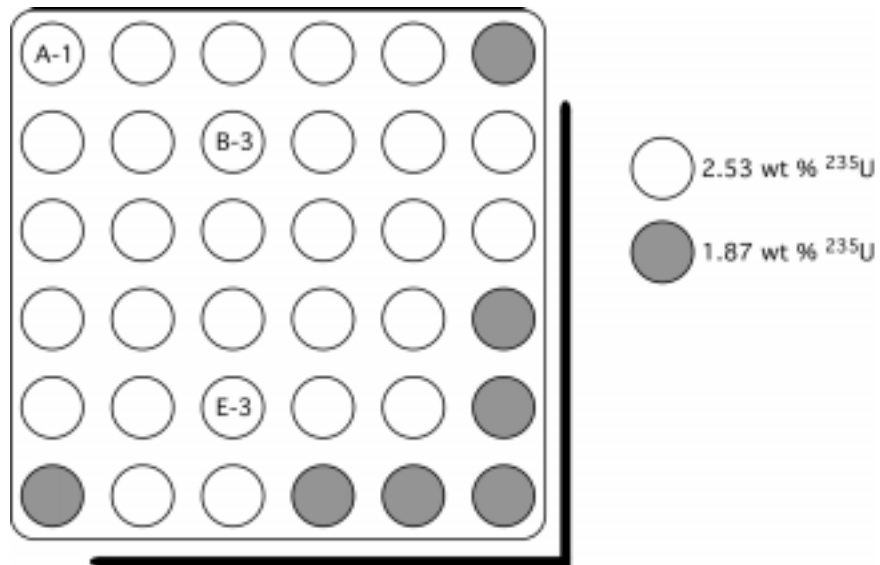

Fig. 3. Locations of fuel rods analyzed in Assembly B23 of Gundremmingen BWR.

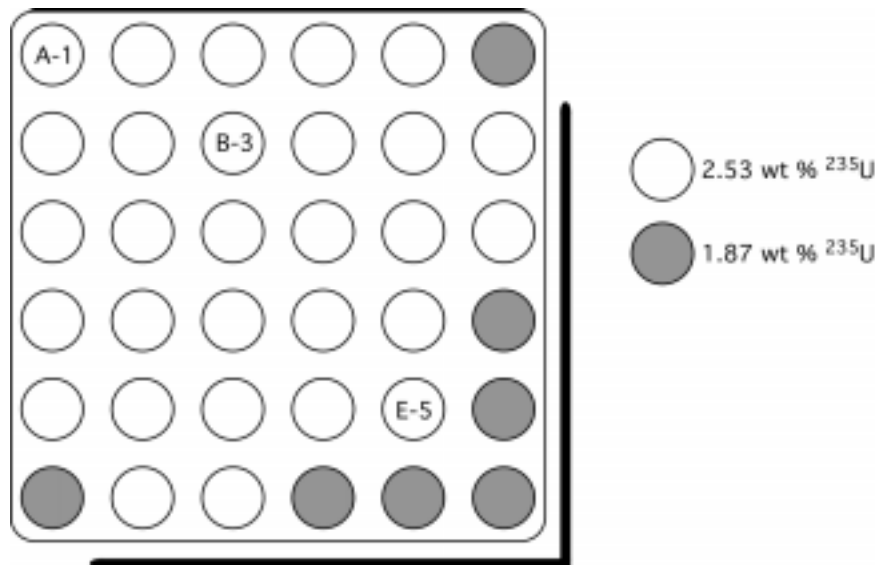

Fig. 4. Locations of fuel rods analyzed in Assembly C16 of Gundremmingen BWR.

Table 7. Initial uranium composition of Gundremmingen BWR fuel samples

Uranium isotope	Assembly ID	
	B23 (wt %)	C16 (wt %)
²³⁵ U	2.530	2.530
²³⁴ U	0.023	0.023
²³⁶ U	0.012	0.012
²³⁸ U	97.435	97.435

Table 8. Operating data for Gundremmingen BWR
Assemblies B23 and C16 and fuel pellet samples

Cycle No.	2	3	4	5
Cycle length, d	279	323	290	309
Shutdown, d	56	33	61	0
Cycle burnup, GWd/MTU				
Assembly B23	5.839	6.131	5.483	5.174
Assembly C16	– ^a	5.959	5.083	6.026
Cycle burnup, GWd/MTU				
B23(A1), 44 cm	6.640	6.972	6.235	5.884
B23(A1), 268 cm	7.071	7.424	6.640	6.265
B23(B3), 268 cm	5.481	5.755	5.147	4.857
B23(E3), 268 cm	6.067	6.370	5.697	5.376
C16(A1), 44 cm	–	7.087	6.046	7.167
C16(A1), 268 cm	–	6.930	5.912	7.008
C16(B3), 268 cm	–	5.024	4.285	5.081
C16(E5), 268 cm	–	6.106	5.209	6.175
Cycle average power, MW/MTU				
Assembly B23 (full)	20.928	18.981	18.907	16.744
B23(A1), 44 cm	23.798	21.584	21.500	19.041
B23(A1), 268 cm	25.343	22.985	22.895	20.276
B23(B3), 268 cm	19.645	17.818	17.748	15.718
B23(E3), 268 cm	21.745	19.722	19.645	17.398
C16(A1), 44 cm	–	21.942	20.847	23.194
C16(A1), 268 cm	–	21.456	20.384	22.680
C16(B3), 268 cm	–	15.554	14.777	16.442
C16(E5), 268 cm	–	18.905	17.961	19.984

^aNot present in core during cycle 2.

applied for the initial (fresh fuel) pass, and a concentration of 6×10^{-6} atoms/barn-cm was applied for the remaining depletion passes.

The assembly unit cell model used in Path B of SAS2H applied 2.530 wt % ^{235}U to the 36 fuel rods in the entire assembly because that was the initial enrichment of the fuel samples. The material and radius of each zone in the assembly model, given in Table 9, were calculated by conserving material mass for assembly dimensions (Table 6). SAS2H case inputs for the Gundremmingen BWR are listed in Appendix C.

Table 9. Effective geometry for Gundremmingen assembly model

Radial zone	Material	Radius (cm)
1	UO ₂ fuel	0.6250
2	Clad of fuel rod	0.7140
3	Moderator outside control rod of unit cell	1.0043
4	Homogenized fuel, clad and moderator (of Path A)	6.026
5	Low-density moderator	6.235
6	Channel tube	6.405
7	Borated moderator outside of channel tube	7.390

2.3 JPDR SPENT FUEL DESIGN AND OPERATING DATA

The JPDR, located at Tokai-mura, Ibaraki-ken, was the first nuclear power facility in Japan. JPDR measurement data, measured by JAERI, were taken from BWR fuel assemblies with a 6×6 pin lattice. The fuel rod lattice data and other fuel assembly design and operating characteristics¹¹ are listed in Table 10. The locations of fuel rods selected for analyses are shown in Fig. 5 for assembly A-20. One rod out of the four rods in the center (i.e., C3, C4, D3, or D4) was selected for the measurements of Assemblies A-14 and A-18.

Table 10. Design and temperature data for JPDR fuel assemblies

Parameter	Data
Assembly general data	
Lattice	6 × 6
Number of fuel rods	36
Equivalent core diameter, cm (in.)	127(50)
Number of fuel assemblies/core	72
Channel tube thickness, cm (in.)	0.15(0.059) ^a
Outer tube flat-to-flat, cm (in.)	12.445(4.90) ^a
Assembly pitch, cm (in.)	13.26(5.22) ^b
Coolant average temperature, K	550
Channel temperature, K	539 ^c
Channel tube material	Zircaloy ^c
Channel tube temperature, K	550 ^c
Assembly fuel, kg U	58.807 ^b
Fuel rod data	
Type fuel pellet	UO ₂
Hot pellet density, g/cm ³	10.13 ^d
Rod pitch, cm (in.)	1.956(0.770)
Rod OD, cm (in.)	1.412(0.556)
Rod ID, cm (in.)	1.260(0.496)
Hot pellet diameter, cm (in.)	1.260(0.496)
Active fuel length, cm (in.)	146.67(57.744)
Effective fuel temperature, K	840 ^e
Clad temperature, K	620 ^e
Clad material	Zircaloy-2

^aNot available in the literature. Data were assumed to be similar to data for Gundremmingen BWR.

^bCalculated from other values listed in this table.

^cNot available in the literature. Assumed the data.

^dAssumed 1% pellet volume dishing and hot pellet diameter.

^eFuel and clad temperatures were not available in the literature. Temperatures given in generic BWR data from ref. 19 were applied.

Sources: Refs. 11 and 19.

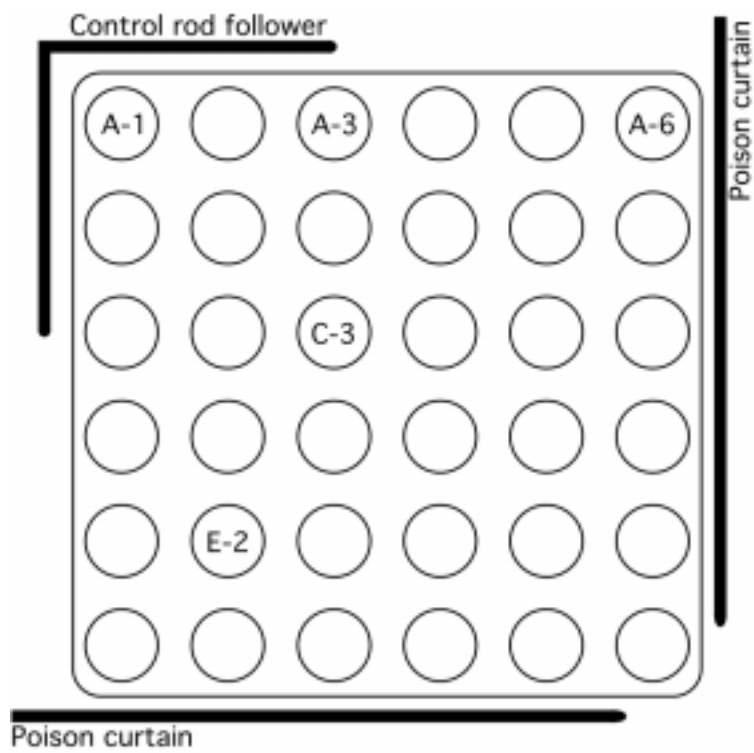

Fig. 5. Locations of fuel rods analyzed in Assembly A-20 of JPDR.

The initial uranium isotopic composition of the fuel in Assemblies A-14, A-18, and A-20 are listed in Table 11. The isotopic contents were specified in at. % and converted to wt % for model input.

Table 11. Initial uranium composition^a of JPDR fuel samples

Uranium isotope	Assemblies A-14, A-18, and A-20	
	At. %	Wt %
²³⁵ U	2.629	2.5966
²³⁴ U	0.0156	0.0153
²³⁶ U	0.0162	0.0161
²³⁸ U	97.339	97.372

^aData were reported¹¹ in at. % for each isotope. Data were converted to wt % for required SAS2H input units.

The JPDR was an exceptionally small reactor. Both the equivalent core diameter and the core height of the JPDR are less than one-half the corresponding dimensions of the other two BWRs. The significance of the reactor core size was investigated by a set of trial cases: one case applied a buckling correction in the transport calculation, reducing k_{eff} to approximately unity; the other case was tried without the buckling option, but with adequate boron content in the channel moderator to decrease the k_{eff} to unity (simulating control rods). Significant differences were noted between concentrations of similar isotopes for some of the nuclide results between the two cases. The analyzed assemblies were located either midway between the core center and the core edge or adjacent to the core edge. Also, documentation indicates that control rods in the vicinity of these assemblies had been fully withdrawn. Thus, it was decided to use the buckling option rather than adding boron to the channel moderator. The detailed model input, which applies the core dimensions taken from Table 10, is listed in Appendix D.

Rather than reporting an estimated burnup for each sample, JPDR fuel depletion was reported in terms of the percent of atoms fissioned (derived from ¹⁴⁸Nd concentrations). For this work, the fission fraction was converted to a burnup by assuming an energy release rate of 200 MeV/fission.

Both the fission fraction and calculated burnup are listed in Table 12. Average specific powers for each sample were calculated from the sample burnup and the total uptime.

Table 12. Operating data for JPDR fuel samples from Assemblies A-14, A-18, and A-20 and total assembly data

Assembly ID	Pin No.	Sample node No.	At. % ^a fissions	Burnup, ^b GWd/MTU	Total uptime, d	Power, MW/MTU
A-14	–	2	0.352	3.0032	577.31	5.7217
A-14	–	9	0.430	4.0351	577.31	6.9895
A-18	–	2	0.289	2.7120	577.31	4.6976
A-18	–	6	0.453	4.2510	577.31	7.3634
A-20	A1	3	0.747	7.0098	577.31	12.1423
A-20	A3	10	0.655	6.1465	577.31	10.6468
A-20	A6	3	0.741	6.9535	577.31	12.0447
A-20	A6	9	0.694	6.5125	577.31	11.2808
A-20	C3	1	0.282	2.6463	577.31	4.5838
A-20	C3	3	0.542	5.0861	577.31	8.8100
A-20	C3	5	0.648	6.0808	577.31	10.5330
A-20	C3	8	0.644	6.0433	577.31	10.4680
A-20	C3	10	0.539	5.0580	577.31	8.7613
A-20	C3	12	0.230	2.1583	577.31	3.7386
A-20	E2	3	0.597	5.6022	577.31	9.7041
A-20	E2	10	0.573	5.3770	577.31	9.3139
A-14	–	–	–	5.570	577.31	9.6482
A-18	–	–	–	5.015	577.31	8.6868
A-20	–	–	–	3.707	577.31	6.4212

^aReported as part of radiochemical analyses data (derived by applying the ¹⁴⁸Nd burnup method).

^bApplied the factor 9.384 times the at. % fissions to convert to burnup as GWd/MTU, assuming 200 MeV/fission (the energy/fission computed by the ORIGEN-S code).

The JPDR was operated at low specific powers and burnups relative to typical commercial BWRs. In addition, JPDR was not a commercial reactor; and is not representative of commercial fuel either in terms of operation or assembly design. These data are considered valuable, however, because they characterize the relatively low burnup and high leakage of fuel located near the ends of typical spent fuel and one of the few sources of BWR data. The operating history of the analyzed assemblies consisted of 38 exposure periods, having an average length of about 2 weeks, and followed by an average downtime of about 6 weeks. This type of exposure history is

unconventional and considerably different from typical exposure histories in commercial BWRs. Although minor variations within operating histories in a reactor fuel cycle are usually ignored in depletion calculations, the short operational periods and relatively long downtimes between power operations for JPDR warranted further study. Based on the exposure history of the Node 2 sample of JDPR assembly A-14, a SAS2H model was developed in which the numerous uptimes and downtimes were represented, assuming four exposure periods and four intervening downtimes, as given in Table 13, in which actual exposure and downtimes were consistent with actual operation. These values were compared with an ORIGEN-S model developed based on a series of 40 exposure periods and 39 downtimes (no downtime preceded the first exposure period); this assumed power history is given in Table 14.

Table 13. Example of power history applied in SAS2H depletion model of Assembly A-14, node 2

Exposure period or SAS2H cycle	Power (MW/MTU)	Uptime (d)	Downtime (d)
1	5.7217	144.33	534.7
2	5.7217	144.33	534.7
3	5.7217	144.33	534.7
4	5.7217	144.33	0
Totals		577.33	1604.1

Note that in general it can be difficult to model a large number of exposure periods using SAS2H, because this sequence creates a burnup-dependent cross-section library for each exposure step. The size of these libraries, combined with the number required, can present filesystem (disk space) problems on most computers. In the confirmatory ORIGEN-S calculations mentioned above, burnup-dependent cross-section libraries created by SAS2H for each of the four SAS2H exposure steps were used by ORIGEN-S (as indicated in the first column of Table 14). Although isotopic predictions can be sensitive to relative up- and downtimes, the cross sections used to generate fluxes for ORIGEN-S are far less sensitive to burnup effects. Thus the use of four SAS2H-prepared cross-section libraries in a tandem with 40 exposure periods in an ORIGEN-S is considered to be a close approximation.

Table 14. Exposure uptimes and downtimes of power history in ORIGEN-S depletion model

SAS2H library No.	Interval uptime, (d)	No. of uptime intervals	Uptimes per library (d)	Interval downtime (d)	No. of downtime intervals	Downtime per library (d)
1	14.433	10	144.33	41.131	9	370.179
2	14.433	10	144.33	41.131	10	411.310
3	14.433	10	144.33	41.131	10	411.310
4	14.433	10	144.33	41.131	10	411.310
Totals			577.32			1604.109

A comparison of results for the detailed ORIGEN-S model and the more coarse SAS2H model showed significant disagreement between results for short-lived (less than 1 year) nuclides. This disagreement would be expected, since such nuclides are known to be sensitive to operating history. However, the results also showed a good agreement in concentration of long-lived (greater than 1 year) or stable nuclides, which are only loosely coupled to operating history effects.³ This study indicated that the use of the four-cycle SAS2H depletion approximation was adequate for applications that require more than 1 year of cooling (e.g., transportation and disposal). Hence this depletion model was applied for all JPDR fuel samples.

Also in departure from commercial reactor design, the JPDR fuel assemblies contained no water holes or poison rods. In other words, all 36 positions in the 6×6 lattice were occupied by fuel rods. The Path B (full-assembly) portion of SAS2H models includes a nonfuel material (e.g., water hole or absorber rod) in the center of the 1-D radial model, representing interstitial nonfuel rods in an assembly. Placement of the homogenized pin-cell materials (mixture 500 from Path A) in the central region of the Path B model results in incorrect fuel depletion. Hence for the Path B SAS2H JPDR models, a very small central zone of ^{14}N was created (zone 1), which was surrounded by the homogenized Path A mixture. The neutronic effect of this approximation is insignificant. Beyond this approximation, however, the methods employed in the development of the SAS2H models for JPDR fuel assemblies are identical to other SAS2H models. Assembly lattice, channel tube, and outer moderator volumes were conserved in developing equivalent radii for the 1-D Path B model. Zone 2 represents the smeared contents of the 6×6 fuel lattice. Zone 3 in the model represents low-

density moderator outside the simple lattice but interior to the channel tube. Zones 4 and 5 represent the channel tube and exterior moderator, respectively. The radii for each zone are given in Table 15. Full SAS2H input listings are provided in Appendix D for all JPDR fuel samples.

Table 15. Effective geometry for JPDR assembly model

Radial zone	Material	Radius (cm)
1	^{14}N	0.0010
2	Homogenized fuel, clad and moderator (from Path A)	6.6213
3	Low-density moderator	6.8521
4	Channel tube	7.0213
5	Moderator outside of channel tube	7.4812

3. PREDICTED AND MEASURED ISOTOPIC COMPOSITIONS

Comparisons of spent PWR fuel isotopic compositions predicted by SCALE-4.3 calculations with those measured by radiochemical assay analyses are provided in this section. Percentage differences between the computed and measured values for isotopes selected for assay analysis are given for each sample. Also included in this section are average percentage differences for each of the three reactors in this validation analysis and for the entire set of analyses included in this study. Additional comparisons listing measurements, computed predictions, and percentage differences for each isotope of each sample are included in Appendixes E, F, and G for Cooper, Gundremmingen, and JPDR, respectively. Some of the measured data were converted from the reported units to units of either milligrams/gram (mg/g) UO_2 (stable/long-lived nuclides) or curies/gram (Ci/g) UO_2 (shorter-lived nuclides).

3.1 COOPER BWR ISOTOPIC RESULTS

Radiochemical isotopic analyses of the Cooper BWR spent fuel were conducted by the MCC at PNL. Isotopic composition measurements of the Cooper spent fuel from two different fuel pins are listed in Tables 16 and 17. The axial locations and burnups of the six fuel specimens analyzed, included in the tables, are two of the major characteristics describing the samples.

The percentage differences between measured and calculated isotopic compositions of each fuel specimen are given in Table 18. This table also provides the average percentage difference of the Cooper BWR samples for each isotope. Percentage differences by sample are also plotted in Fig. 6.

Table 16. Measured irradiation composition, in g/g UO₂, of Cooper BWR fuel

Nuclide	Pin ID and axial location, cm from bottom of fuel (Burnup, ^a GWd/MTU)					
	Pin B3 ^b 351.7 cm (18.96)	Pin B3 ^b 186.9 cm (30.07)	Pin B3 ^b 131.0 cm (33.94)	Pin C3 ^c 350.1 cm (17.84)	Pin C3 ^c 290.7 cm (29.23)	Pin C3 ^c 114.7 cm (31.04)
²³⁴ U	1.7 × 10 ⁻⁴	1.35 × 10 ⁻⁴	1.44 × 10 ⁻⁴	1.74 × 10 ⁻⁴	1.46 × 10 ⁻⁴	1.54 × 10 ⁻⁴
²³⁵ U	1.191 × 10 ⁻²	5.34 × 10 ⁻³	4.83 × 10 ⁻³	1.30 × 10 ⁻²	7.76 × 10 ⁻³	6.28 × 10 ⁻³
²³⁶ U	2.63 × 10 ⁻³	3.53 × 10 ⁻³	3.62 × 10 ⁻³	2.48 × 10 ⁻³	3.36 × 10 ⁻³	3.48 × 10 ⁻³
²³⁸ U	8.437 × 10 ⁻¹	8.346 × 10 ⁻¹	8.391 × 10 ⁻¹	8.545 × 10 ⁻¹	8.490 × 10 ⁻¹	8.455 × 10 ⁻¹
²³⁸ Pu	5.35 × 10 ⁻⁵	1.743 × 10 ⁻⁴	1.706 × 10 ⁻⁴	5.21 × 10 ⁻⁵	1.64 × 10 ⁻⁴	1.389 × 10 ⁻⁴
²³⁹ Pu	3.738 × 10 ⁻³	3.579 × 10 ⁻³	3.336 × 10 ⁻³	4.056 × 10 ⁻³	4.526 × 10 ⁻³	3.668 × 10 ⁻³
²⁴⁰ Pu	1.220 × 10 ⁻³	2.216 × 10 ⁻³	2.190 × 10 ⁻³	1.184 × 10 ⁻³	2.164 × 10 ⁻³	2.082 × 10 ⁻³
²⁴¹ Pu	3.403 × 10 ⁻⁴	6.390 × 10 ⁻⁴	6.201 × 10 ⁻⁴	3.415 × 10 ⁻⁴	6.649 × 10 ⁻⁴	6.139 × 10 ⁻⁴
²⁴² Pu	9.892 × 10 ⁻⁷	4.407 × 10 ⁻⁴	4.737 × 10 ⁻⁴	8.742 × 10 ⁻⁵	3.247 × 10 ⁻⁴	3.823 × 10 ⁻⁴

^aBased on measured ¹⁴⁸Nd concentration.

^bRadiochemical analyses conducted at a cooling time of 5.35 years, or 1954 days.

^cRadiochemical analyses conducted at a cooling time of 5.28 years, or 1929 days.

Source: Ref. 10.

Table 17. Measured irradiation composition, in Ci/g UO₂, of Cooper BWR fuel

Nuclide	Pin ID and axial location, cm from bottom of fuel (Burnup, GWd/MTU)					
	Pin B3 351.7 cm (18.96)	Pin B3 186.9 cm (30.07)	Pin B3 131.0 cm (33.94)	Pin C3 350.1 cm (17.84)	Pin C3 290.7 cm (29.23)	Pin C3 114.7 cm (31.04)
²³⁷ Np	1.11 × 10 ⁻⁷	2.54 × 10 ⁻⁷	2.46 × 10 ⁻⁷	1.09 × 10 ⁻⁷	2.35 × 10 ⁻⁷	2.36 × 10 ⁻⁷
²⁴¹ Am	5.18 × 10 ⁻⁴	8.78 × 10 ⁻⁴	8.38 × 10 ⁻⁴	5.23 × 10 ⁻⁴	9.46 × 10 ⁻⁴	8.69 × 10 ⁻⁴
²⁴³ Cm + ²⁴⁴ Cm	1.10 × 10 ⁻⁴	1.45 × 10 ⁻³	1.50 × 10 ⁻³	1.14 × 10 ⁻⁴	1.10 × 10 ⁻³	1.07 × 10 ⁻³
⁷⁹ Se	2.77 × 10 ⁻⁸	4.59 × 10 ⁻⁸	4.96 × 10 ⁻⁸	2.70 × 10 ⁻⁸	4.26 × 10 ⁻⁸	4.50 × 10 ⁻⁸
⁹⁰ Sr	3.21 × 10 ⁻²	4.86 × 10 ⁻²	5.09 × 10 ⁻²	2.92 × 10 ⁻²	4.38 × 10 ⁻²	4.82 × 10 ⁻²
⁹⁹ Tc	6.26 × 10 ⁻⁶	1.03 × 10 ⁻⁵	1.06 × 10 ⁻⁵	6.17 × 10 ⁻⁶	9.86 × 10 ⁻⁶	1.00 × 10 ⁻⁵
¹²⁶ Sn	7.79 × 10 ⁻⁸	1.52 × 10 ⁻⁷	1.60 × 10 ⁻⁷	7.34 × 10 ⁻⁸	1.41 × 10 ⁻⁷	1.46 × 10 ⁻⁷
¹³⁵ Cs	3.74 × 10 ⁻⁷	4.46 × 10 ⁻⁷	4.29 × 10 ⁻⁷	3.83 × 10 ⁻⁷	5.23 × 10 ⁻⁷	4.31 × 10 ⁻⁷
¹³⁷ Cs	4.27 × 10 ⁻²	7.48 × 10 ⁻²	7.70 × 10 ⁻²	4.05 × 10 ⁻²	7.25 × 10 ⁻²	6.85 × 10 ⁻²

Source: Ref. 10.

Table 18. Percentage difference^a between measured and computed^b nuclide compositions for Cooper BWR samples and averages from Assembly CZ346

Pin	B3	B3	B3	C3	C3	C3		
Axial height, cm	351.7	186.9	131.0	350.1	290.7	114.7		
Burnup, GWd/MTU	18.96	30.07	33.94	17.84	29.23	31.04		
Initial wt % ²³⁵ U	2.939	2.939	2.939	2.939	2.939	2.939		
Nuclide							Average	Std. Deviation
²³⁴ U	-0.3	3.1	-4.1	-0.9	-0.1	-6.1	-1.4	3.2
²³⁵ U	-1.3	-0.1	-2.6	-4.9	-9.5	-11.7	-5.0	4.7
²³⁶ U	-0.7	-1.6	-3.1	1.3	-1.9	-2.0	-1.3	1.5
²³⁸ U	-0.1	-0.1	-0.5	-1.2	-1.5	-1.1	-0.7	0.6
²³⁸ Pu	-1.0	-7.0	-6.8	-11.9	-7.0	-6.9	-6.8	3.5
²³⁹ Pu	6.3	8.8	7.7	-3.9	-6.9	-4.3	1.3	7.0
²⁴⁰ Pu	2.1	-6.0	-5.0	-1.9	-11.1	-7.6	-4.9	4.6
²⁴¹ Pu	17.1	7.5	5.9	7.4	-1.1	-2.6	5.7	7.1
²⁴² Pu	22.7	5.5	4.8	18.5	7.4	5.4	10.7	7.8
²³⁷ Np	17.3	-4.2	-3.2	10.1	-5.6	-10.8	0.6	10.7
²⁴¹ Am	28.4	20.3	18.9	16.5	8.9	5.1	16.3	8.4
²⁴⁴ Cm	41.4	18.1	15.5	2.0	1.0	2.8	13.5	15.5
⁷⁹ Se	24.9	28.1	21.7	20.8	22.8	23.6	23.6	2.6
⁹⁰ Sr	5.9	10.2	8.2	10.8	10.4	7.7	8.9	1.9
⁹⁹ Tc	14.1	14.6	14.5	9.5	7.0	12.6	12.1	3.1
¹²⁶ Sn	206.1	218.4	210.0	200.2	195.3	200.9	205.2	8.2
¹³⁵ Cs	10.4	8.7	8.7	4.5	-6.5	4.6	5.1	6.2
¹³⁷ Cs	3.6	3.3	3.1	3.0	-5.7	6.2	2.3	4.1

^a(Calculated/measured – 1) × 100%.

^bUsing SAS2H/ORIGEN-S analysis sequence and the 44-group cross-section library of SCALE-4.3.

- | | |
|------------------------------|------------------------------|
| ○ B3, 351.7cm, 18.96 GWd/MTU | × C3, 350.1cm, 17.84 GWd/MTU |
| □ B3, 186.9cm, 30.07 GWd/MTU | + C3, 290.7cm, 29.23 GWd/MTU |
| ◇ B3, 131cm, 33.94 GWd/MTU | △ C3, 114.7cm, 31.04 GWd/MTU |

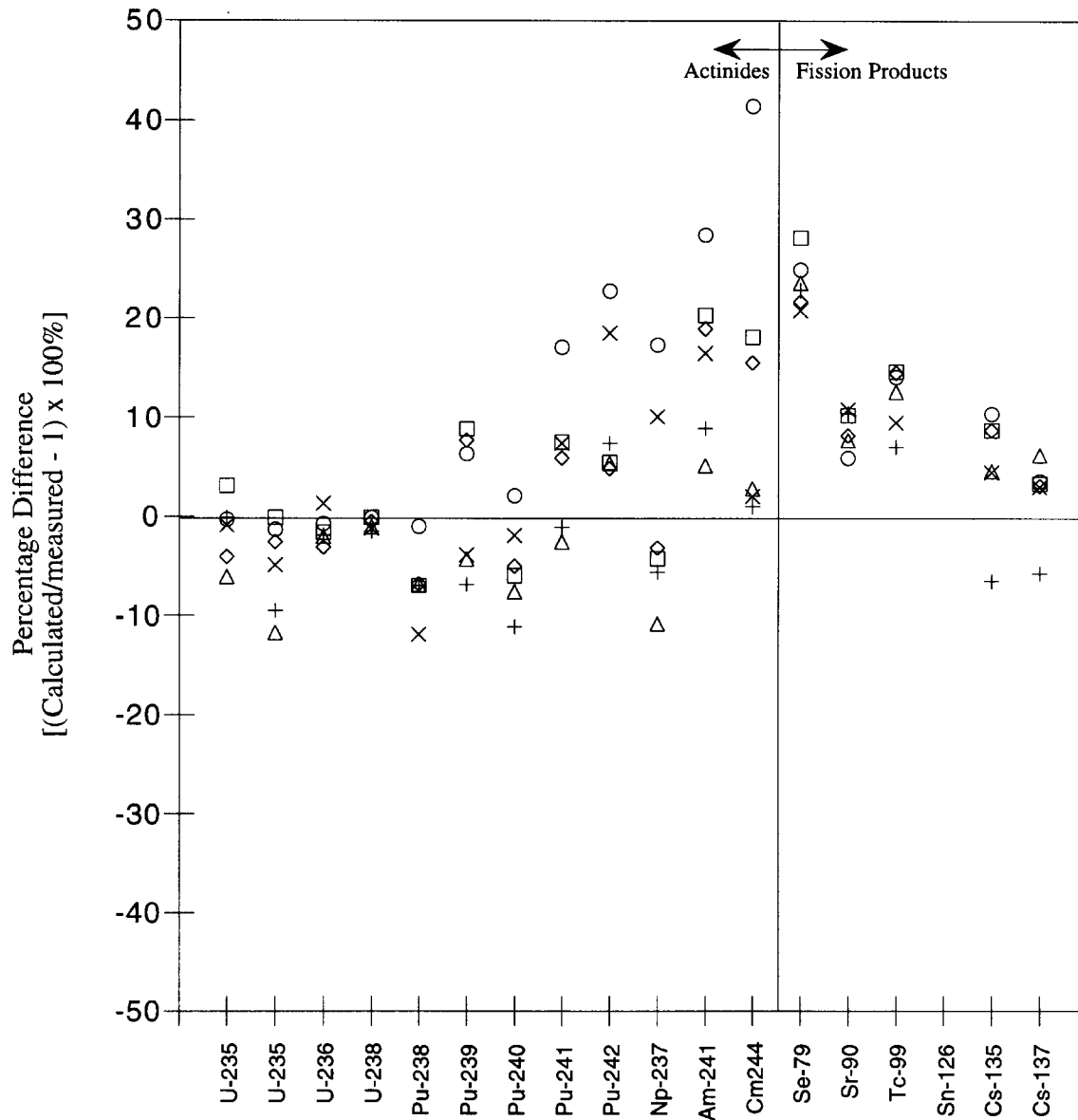

Fig. 6. Percentage differences between measured and calculated results for Cooper fuel samples.

3.2 GUNDREMMINGEN BWR ISOTOPIC RESULTS

Radiochemical isotopic analyses of Gundremmingen BWR spent fuel were conducted by the Ispra and Karlsruhe facilities of EJRC. The spent fuel specimens taken from pin A1 of Assemblies B23 and C16 were analyzed at Ispra only; all other sample analyses were performed at both the Karlsruhe and the Ispra establishments. For twice-measured samples, the average of the two measurements was reported. Isotopic composition measurements from six different pins (from two fuel assemblies) are listed in Table 19. The compositions were reported in several types of units; each type of reported measurement is specified in the table. However, all data were converted to units of milligrams per initial gram of uranium or curies per initial gram of uranium (shown in Appendix F) for consistency with previous validation studies. Axial locations and burnups characterizing the samples are listed with the same measurements in Table 19. The percentage differences between measured and SCALE-predicted isotopic compositions are presented in Table 20 and are plotted as a function of isotope in Fig. 7.

3.3 JPDR ISOTOPIC RESULTS

Radiochemical analyses of the JPDR spent BWR fuel were performed at JAERI. Isotopic composition measurements of 16 pellet samples from several fuel pins of three different fuel assemblies are listed in Tables 21 and 22. The compositions are given in several different units, as reported. All data were subsequently converted into units of milligram per gram of initial uranium (shown in Appendix G) for consistency with previous studies. Axial locations and burnups of the samples are listed with the associated measurements in the tables. The percentage differences between measured and predicted concentrations are listed in Table 23. Figure 8 illustrates these percentage differences for each sample as a function of a nuclide.

Table 19. Average measured irradiation composition of Gundremmingen BWR fuel

Assembly ID	B23 A1	B23 A1	B23 A1	B23 E3	C16 A1	C16 A1	C16 A1	C16 B3	C16 E5
Fuel pin ID	44	268	268	268	268	268	268	268	268
Axial height, cm	27.40	27.40	21.24	23.51	19.85	19.85	14.39	17.49	17.49
Burnup, ^a GWd/MTU	1047	1053	1010	1244	1244	1244	1060.5	1004	1004
Cooling time to Pu analyses, ^b d									
Nuclide	Units of reported analyses								
²³⁵ U	1.923	1.879	1.567	1.689	1.692	1.569	1.234	1.504	1.504
²³⁶ U	3.46 × 10 ⁻³	3.49 × 10 ⁻³	3.115 × 10 ⁻³	3.31 × 10 ⁻³	3.23 × 10 ⁻³	3.05 × 10 ⁻³	2.57 × 10 ⁻³	2.875 × 10 ⁻³	2.875 × 10 ⁻³
²³⁸ U	1.828	2.241	1.8485	1.969	1.363	1.523	1.2225	1.310	1.310
²³⁸ Pu	6.8 × 10 ⁻²	1.08 × 10 ⁻¹	8.3 × 10 ⁻²	8.4 × 10 ⁻²	3.6 × 10 ⁻²	4.8 × 10 ⁻²	3.3 × 10 ⁻²	4.1 × 10 ⁻²	4.1 × 10 ⁻²
²³⁹ Pu	3.72	4.78	5.35	4.80	3.62	4.40	4.675	4.14	4.14
²⁴⁰ Pu	1.80	2.15	1.84	1.83	1.46	1.52	1.16	1.43	1.43
²⁴¹ Pu	1.872 × 10 ⁻¹	1.971 × 10 ⁻¹	1.45 × 10 ⁻¹	1.497 × 10 ⁻¹	1.42 × 10 ⁻¹	1.459 × 10 ⁻¹	1.0155 × 10 ⁻¹	1.271 × 10 ⁻¹	1.271 × 10 ⁻¹
²⁴² Pu	3.25 × 10 ⁻¹	4.42 × 10 ⁻¹	2.195 × 10 ⁻¹	2.42 × 10 ⁻¹	1.79 × 10 ⁻¹	1.98 × 10 ⁻¹	8.75 × 10 ⁻²	1.475 × 10 ⁻¹	1.475 × 10 ⁻¹
²⁴⁴ Cm	8.65	1.928 × 10 ¹	8.41	8.95	2.55	4.37	1.53	2.725	2.725
¹³⁴ Cs	3.49 × 10 ⁹	3.28 × 10 ⁹	2.57 × 10 ⁹	3.00 × 10 ⁹	2.26 × 10 ⁹	2.85 × 10 ⁹	1.45 × 10 ⁹	1.63 × 10 ⁹	1.63 × 10 ⁹
¹³⁷ Cs	3.66 × 10 ⁹	2.89 × 10 ⁹	2.64 × 10 ⁹	2.75 × 10 ⁹	2.55 × 10 ⁹	2.69 × 10 ⁹	1.87 × 10 ⁹	2.12 × 10 ⁹	2.12 × 10 ⁹
¹⁴⁸ Nd	4.88 × 10 ⁻⁴	5.22 × 10 ⁻⁴	4.03 × 10 ⁻⁴	4.58 × 10 ⁻⁴	3.80 × 10 ⁻⁴	3.72 × 10 ⁻⁴	2.73 × 10 ⁻⁴	3.33 × 10 ⁻⁴	3.33 × 10 ⁻⁴
¹⁵⁴ Eu	1.79 × 10 ⁸	1.80 × 10 ⁸	1.55 × 10 ⁸	1.53 × 10 ⁸	8.9 × 10 ⁷	1.09 × 10 ⁸	7.5 × 10 ⁷	8.4 × 10 ⁷	8.4 × 10 ⁷

^aBased on measured ¹⁴⁸Nd concentration.

^bCooling times at dates of Pu mass spectrometer ratio analyses. Assumed the same time for other analyses unless stated otherwise.

^cMeasurements converted to disintegrations per second at reactor shutdown.

Source: Ref. 11.

Table 20. Percentage difference^a between measured and computed^b nuclide compositions for Gundremmingen BWR samples and averages from Assemblies B23 and C16

Assembly ID	B23 A1	B23 A1	B23 E3	B23 B3	B23 E3	C16 A1	C16 A1	C16 A1	C16 B3	C16 E5	Average	Std. Deviation
Fuel pin ID	44	268	268	268	268	268	268	268	268	268		
Axial height, cm	25.7	27.4	21.2	21.2	23.5	20.3	19.8	14.4	17.5			
Burnup, GWd/MTU												
Nuclide												
²³⁵ U	-4.7	-4.0	-7.6	-7.0	-7.0	-2.5	0.2	-2.6	4.0	-3.0	3.8	
²³⁶ U	-1.4	-2.5	-2.4	-3.1	-3.1	-4.3	-7.8	-7.0	-5.9	-4.3	2.4	
²³⁸ U	0.1	0.0	0.2	0.2	0.2	0.0	0.0	0.1	0.0	0.1	0.1	
²³⁸ Pu	8.2	19.5	-18.3	0.4	0.4	8.7	22.8	-24.0	-4.1	1.6	16.7	
²³⁹ Pu	-1.4	1.5	-15.6	-4.0	-4.0	-3.3	1.0	-17.3	-0.5	-4.9	7.4	
²⁴⁰ Pu	0.7	6.9	-7.9	2.6	2.6	1.2	3.1	-7.8	-6.2	-0.9	5.6	
²⁴¹ Pu	-9.9	-2.9	-16.0	-1.4	-1.4	-9.5	0.7	-19.7	-3.3	-7.7	7.3	
²⁴² Pu	12.3	5.9	-2.2	12.9	12.9	-7.2	5.4	-9.4	-9.8	-2.1	9.4	
²⁴⁴ Cm	-8.4	4.1	-33.2	-2.4	-2.4	-16.8	5.5	-49.4	-25.5	-15.8	19.3	
¹³⁴ Cs	15.3	-12.3	-10.7	-6.5	-6.5	-23.4	-7.7	-20.6	4.0	-7.7	12.6	
¹³⁷ Cs	17.3	-13.1	-1.2	5.3	5.3	-8.5	-1.0	-5.2	2.0	-0.5	9.3	
¹⁴⁸ Nd	-2.1	-2.0	-1.8	-4.4	-4.4	-0.7	-0.8	-2.1	-2.4	-2.0	1.1	
¹⁵⁴ Eu	-0.3	-27.7	-27.1	-10.8	-10.8	-12.4	-6.1	-32.3	-11.0	-15.9	11.6	

^a(Calculated/measured - 1) × 100%.

^bUsing SAS2H/ORIGEN-S analysis sequence and the 44-group cross-section library of SCALE-4.3.

- B23/A1, 44cm, 25.7 GWd/MTU
- B23/A1, 268cm, 27.4 GWd/MTU
- ◇ B23/B3, 268cm, 21.2 GWd/MTU
- × B23/E3, 268cm, 23.5 GWd/MTU
- + C16/A1, 44cm, 20.3 GWd/MTU
- △ C16/A1, 268cm, 19.8 GWd/MTU
- C16/B3, 268cm, 14.4 GWd/MTU
- C16/E5, 268cm, 17.5 GWd/MTU

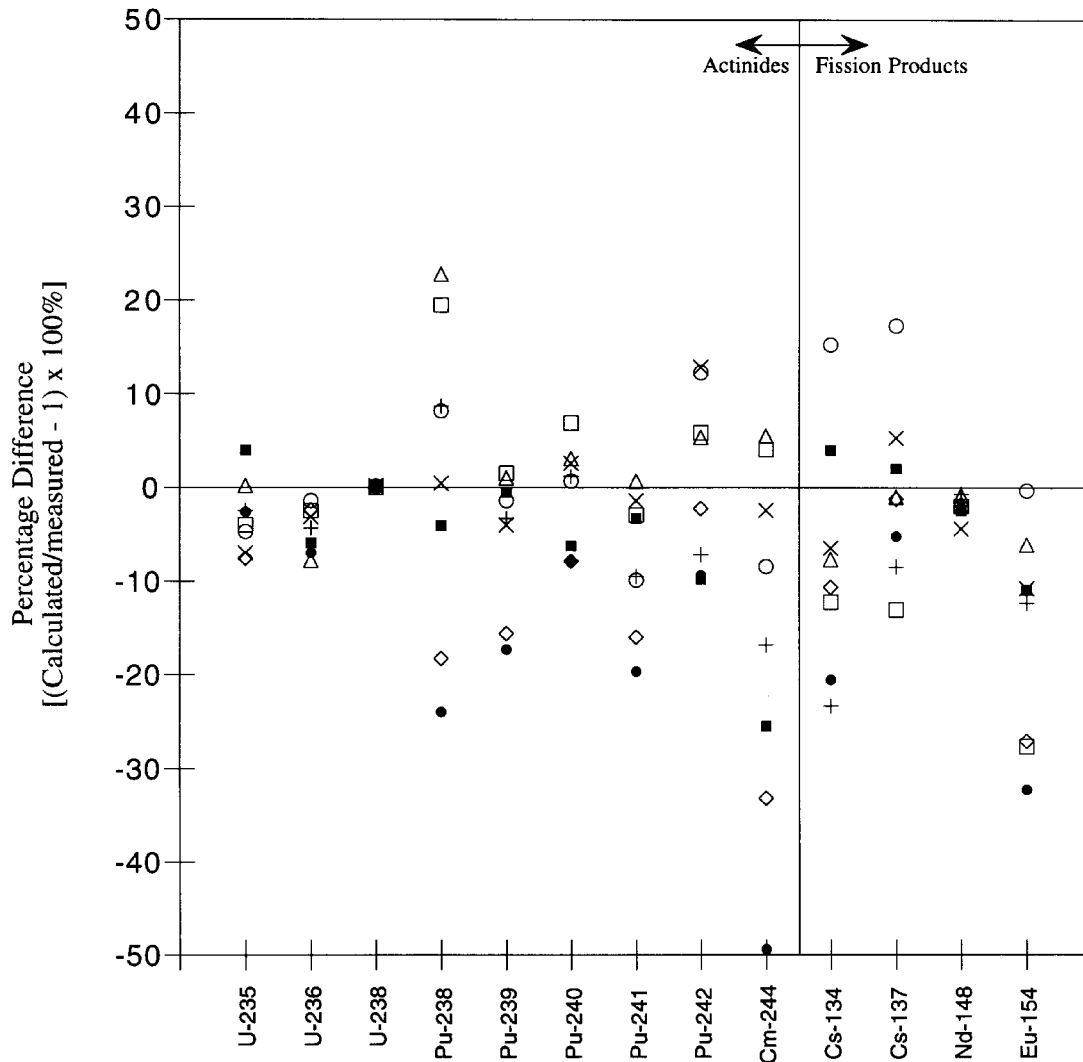

Fig. 7. Percentage differences between measured and calculated results for Gundremmingen fuel samples.

Table 21. Measured irradiation composition^a of JPDR spent fuel from eight samples

Assembly ID	A-14	A-14	A-18	A-18	A-20	A-20	A-20	A-20	A-20
Fuel pin ID or position	mid-rod	mid-rod	mid-rod	mid-rod	A1	A3	A6	A6	A6
Axial height, cm	129.6	129.6	129.6	80.7	117.4	31.8	117.4	117.4	117.4
Burnup, ^b GWd/MTU	3.30	4.04	2.71	4.25	7.01	6.15	6.95	6.95	6.51
Cooling time to Pu analyses, d	1092	1039	1089	1038	1296	1387	1296	1296	1380
Nuclide or element									
U									
atoms final U/sample	1.528×10^{22}	1.382×10^{22}	1.477×10^{22}	1.365×10^{22}	1.280×10^{22}	1.395×10^{22}	1.214×10^{22}	1.214×10^{22}	1.144×10^{22}
atoms Pu/sample	2.540×10^{19}	2.520×10^{19}	1.940×10^{19}	2.580×10^{19}	3.600×10^{19}	3.280×10^{19}	3.520×10^{19}	3.520×10^{19}	2.930×10^{19}
atoms ¹⁴⁸ Nd/sample	0.909×10^{18}	1.005×10^{18}	0.716×10^{18}	1.046×10^{18}	1.634×10^{18}	1.559×10^{18}	1.537×10^{18}	1.537×10^{18}	1.356×10^{18}
at. % of final U	0.0150	0.0145	0.0150	0.0149	0.0139	0.0147	0.0138	0.0138	0.0140
at. % of final U	2.292	2.194	2.334	2.194	1.931	1.933	1.918	1.918	1.951
at. % of final U	0.0808	0.0925	0.0699	0.0940	0.1416	0.1232	0.1401	0.1401	0.1337
at. % of final U	97.16	97.699	97.581	97.697	97.914	97.929	97.928	97.928	97.901
at. % of Pu	0.051	0.060	0.023	0.066	0.128	0.103	0.135	0.135	0.117
at. % of Pu	92.16	90.45	93.54	90.16	84.39	86.11	84.37	84.37	85.28
at. % of Pu	6.81	8.26	5.78	8.44	12.53	11.58	12.41	12.41	12.06
at. % of Pu	0.94	1.18	0.64	1.27	2.71	2.05	2.84	2.84	2.34
at. % of Pu	0.034	0.055	0.0145	0.063	0.238	0.164	0.246	0.246	0.201
at. % of Nd	27.50	27.29	27.67	27.24	26.29	26.60	26.34	26.34	26.52
at. % of Nd	26.94	27.28	26.82	27.25	28.16	27.98	28.11	28.11	28.10
at. % of Nd	18.78	18.74	18.82	18.74	18.47	18.59	18.52	18.52	18.55
at. % of Nd	14.87	14.85	14.83	14.90	15.08	14.95	15.04	15.04	14.96
at. % of Nd	8.37	8.33	8.34	8.34	8.43	8.37	8.45	8.45	8.36
at. % of Nd	3.54	3.52	3.52	3.52	3.57	3.51	3.55	3.55	3.53
atoms/sample	–	–	–	–	5.12×10^{17}	4.43×10^{17}	5.10×10^{17}	5.10×10^{17}	4.09×10^{17}
atoms/sample	0.509×10^{17}	0.677×10^{17}	0.266×10^{17}	0.806×10^{17}	2.33×10^{17}	1.822×10^{17}	2.56×10^{17}	2.56×10^{17}	1.835×10^{17}
atoms/sample	–	–	–	–	9.50×10^{14}	6.50×10^{14}	12.10×10^{14}	12.10×10^{14}	7.90×10^{14}
atoms/sample	3.95×10^{12}	5.45×10^{12}	1.65×10^{12}	7.23×10^{12}	1.14×10^{13}	7.80×10^{12}	13.20×10^{12}	13.20×10^{12}	8.60×10^{12}
atoms/sample	0.33×10^{13}	0.59×10^{13}	8.40×10^{11}	0.85×10^{13}	9.90×10^{13}	4.10×10^{13}	11.90×10^{13}	11.90×10^{13}	5.90×10^{13}
atoms/final U atom ^c	–	–	–	–	2.910×10^{-6}	2.155×10^{-6}	3.094×10^{-6}	3.094×10^{-6}	2.424×10^{-6}
atoms/final U atom ^c	–	–	–	–	2.707×10^{-6}	1.848×10^{-6}	2.875×10^{-6}	2.875×10^{-6}	2.206×10^{-6}
atoms/final U atom ^c	2.134×10^{-4}	2.612×10^{-4}	1.679×10^{-4}	2.659×10^{-4}	4.037×10^{-4}	3.495×10^{-4}	4.042×10^{-4}	4.042×10^{-4}	3.733×10^{-4}
atoms/final U atom ^c	–	–	–	–	4.546×10^{-6}	3.829×10^{-6}	4.811×10^{-6}	4.811×10^{-6}	4.075×10^{-6}
atoms/final U atom ^c	–	–	–	–	1.119×10^{-6}	8.045×10^{-7}	1.184×10^{-6}	1.184×10^{-6}	9.260×10^{-7}
atoms/final U atom ^c	–	–	–	–	1.172×10^{-6}	9.805×10^{-7}	1.205×10^{-6}	1.205×10^{-6}	1.112×10^{-6}

^aBased on measured ¹⁴⁸Nd concentration.

^bCooling times at dates of Pu mass spectrometer ratio analyses. Assumed the same time for other analyses unless stated otherwise.

^cMeasurements converted to disintegrations per second at reactor shutdown.

Source: Ref. 11.

Table 22. Measured irradiation composition^a of JPDR spent fuel from eight additional samples

Assembly ID	A-20	A-20	A-20	A-20	A-20	A-20	A-20	A-20	A-20	A-20	A-20
Fuel pin ID or position	C3	C3	C3	C3	C3	C3	C3	C3	C3	C3	E2
Axial height, cm	141.8	117.4	92.9	56.2	31.8	31.8	56.2	31.8	7.3	117.4	E2
Burnup, ^b GWd/MTU	2.65	5.09	6.08	6.04	5.06	5.06	6.04	5.06	2.16	5.60	5.38
Cooling time to Pu analyses, d	1215	1219	1221	1235	1226	1226	1235	1226	1216	1320	1331
Nuclide or element											
U											
atoms final U/sample	1.165×10^{22}	1.010×10^{22}	0.882×10^{22}	1.338×10^{22}	1.429×10^{22}	1.332×10^{22}	1.338×10^{22}	1.429×10^{22}	1.332×10^{22}	1.727×10^{22}	0.945×10^{22}
atoms Pu/sample	1.570×10^{19}	2.570×10^{19}	2.540×10^{19}	3.670×10^{19}	3.170×10^{19}	1.342×10^{19}	3.670×10^{19}	3.170×10^{19}	1.342×10^{19}	4.480×10^{19}	2.130×10^{19}
atoms ¹⁴⁸ Nd/sample	0.557×10^{18}	0.933×10^{18}	0.976×10^{18}	1.471×10^{18}	1.314×10^{18}	0.520×10^{18}	1.471×10^{18}	1.314×10^{18}	0.520×10^{18}	1.758×10^{18}	0.924×10^{18}
at. % of final U	0.0149	0.0140	0.0137	0.0148	0.0149	0.0154	0.0148	0.0149	0.0154	0.0144	0.0145
at. % of final U	2.357	2.112	2.032	2.004	2.096	2.391	2.004	2.096	2.391	2.062	2.056
at. % of final U	0.0699	0.1115	0.1288	0.1282	0.1111	0.0591	0.1282	0.1111	0.0591	0.1197	0.1181
at. % of final U	97.558	97.762	97.826	97.853	97.777	97.534	97.853	97.777	97.534	97.804	97.811
at. % of Pu	0.039	0.101	0.130	0.121	0.086	0.025	0.121	0.086	0.025	0.108	0.094
at. % of Pu	93.51	88.34	86.24	86.20	88.22	94.71	86.20	88.22	94.71	87.36	87.45
at. % of Pu	5.76	9.44	10.92	11.08	9.80	4.85	11.08	9.80	4.85	10.19	10.43
at. % of Pu	0.67	2.00	2.53	2.42	1.78	0.40	2.42	1.78	0.40	2.19	1.90
at. % of Pu	0.020	0.120	0.183	0.180	0.109	0.010	0.180	0.109	0.010	0.145	0.126
at. % of Nd	27.72	26.95	26.59	26.63	26.94	27.93	26.63	26.94	27.93	26.75	26.85
at. % of Nd	26.82	27.37	27.61	27.71	27.52	26.82	27.71	27.52	26.82	27.57	27.77
at. % of Nd	18.81	18.60	18.58	18.58	18.68	18.89	18.58	18.68	18.89	18.57	18.57
at. % of Nd	14.81	15.03	15.10	15.05	14.94	14.66	15.05	14.94	14.66	15.03	14.92
at. % of Nd	8.33	8.42	8.46	8.41	8.39	8.28	8.41	8.39	8.28	8.42	8.36
at. % of Nd	3.50	3.63	3.65	3.61	3.54	3.42	3.61	3.54	3.42	3.60	3.53
atoms/sample	1.68×10^{17}	3.56×10^{17}	3.67×10^{17}	5.15×10^{17}	3.97×10^{17}	1.29×10^{17}	5.15×10^{17}	3.97×10^{17}	1.29×10^{17}	6.26×10^{17}	2.89×10^{17}
atoms/sample	0.259×10^{17}	1.276×10^{17}	1.608×10^{17}	2.190×10^{17}	1.440×10^{17}	0.135×10^{17}	2.190×10^{17}	1.440×10^{17}	0.135×10^{17}	2.45×10^{17}	1.057×10^{17}
atoms/sample	0.61×10^{14}	2.00×10^{14}	5.60×10^{14}	10.40×10^{14}	3.50×10^{14}	0.34×10^{14}	10.40×10^{14}	3.50×10^{14}	0.34×10^{14}	6.30×10^{14}	3.10×10^{14}
atoms/sample	0.55×10^{12}	5.10×10^{12}	7.70×10^{12}	10.10×10^{12}	5.50×10^{12}	0.21×10^{12}	10.10×10^{12}	5.50×10^{12}	0.21×10^{12}	10.2×10^{12}	4.10×10^{12}
atoms/sample	8.80×10^{11}	3.40×10^{13}	6.30×10^{13}	7.10×10^{13}	2.30×10^{13}	2.50×10^{11}	7.10×10^{13}	2.30×10^{13}	2.50×10^{11}	6.90×10^{13}	2.10×10^{13}
atoms/final U atom ^c	8.359×10^7	2.064×10^6	2.577×10^6	2.389×10^6	1.691×10^6	5.430×10^7	2.389×10^6	1.691×10^6	5.430×10^7	2.279×10^6	1.853×10^6
atoms/final U atom ^c	4.294×10^7	1.695×10^6	2.358×10^6	2.082×10^6	1.364×10^6	2.464×10^7	2.082×10^6	1.364×10^6	2.464×10^7	1.944×10^6	1.551×10^6
atoms/final U atom ^c	1.485×10^4	2.879×10^4	3.466×10^4	3.387×10^4	2.826×10^4	1.222×10^4	3.387×10^4	2.826×10^4	1.222×10^4	3.206×10^4	3.079×10^4
atoms/final U atom ^c	1.869×10^6	3.309×10^6	3.993×10^6	3.756×10^6	2.968×10^6	1.340×10^6	3.756×10^6	2.968×10^6	1.340×10^6	3.725×10^6	3.318×10^6
atoms/final U atom ^c	1.781×10^7	7.450×10^7	1.049×10^6	9.145×10^7	6.035×10^7	1.065×10^7	9.145×10^7	6.035×10^7	1.065×10^7	8.502×10^7	6.749×10^7
atoms/final U atom ^c	—	—	—	—	—	—	—	—	—	9.789×10^7	9.257×10^7

^aBased on measured ¹⁴⁸Nd concentration.

^bCooling times at dates of Pu mass spectrometer ratio analyses. Assumed the same time for other analyses unless stated otherwise.

^cMeasurements converted to disintegrations per second at reactor shutdown.

Source: Ref. 11.

Table 23. Percentage difference^a between measured and computed^b nuclide composition for JPDR samples and averages from Assemblies A-14, A-18, and A-20

Assembly ID Fuel pin ID or positions Axial height, cm Burnup, GWd/MTU	A-14 mid-rod 129.6 3.30	A-14 mid-rod 44.0 4.04	A-18 mid-rod 129.6 2.71	A-18 mid-rod 80.7 4.25	A-20 A1 117.4 7.01	A-20 A3 31.8 6.15	A-20 A6 117.4 6.95	A-20 A6 44.0 6.51
Nuclide								
²³⁴ U	-0.9	1.8	-0.2	-1.4	1.7	-2.4	2.6	2.0
²³⁵ U	-1.1	-0.3	-0.2	-1.1	-1.1	2.5	-0.2	-0.2
²³⁶ U	-0.2	0.8	0.1	3.4	0.7	4.5	1.2	0.6
²³⁸ U	0.0	0.0	0.0	0.0	0.0	-0.1	0.0	0.0
²³⁸ Pu	-23.1	-19.6	45.3	-12.2	4.0	0.4	-6.3	-5.8
²³⁹ Pu	-5.1	-4.5	3.2	0.4	2.8	5.3	-0.8	1.7
²⁴⁰ Pu	-1.7	-2.8	6.7	3.7	4.5	6.8	1.1	3.3
²⁴¹ Pu	-10.8	-7.6	4.7	3.2	2.1	8.7	-7.1	0.3
²⁴² Pu	-5.6	-5.6	42.9	4.4	6.1	8.8	-3.1	-0.1
²³⁷ Np	-	-	-	-	11.5	9.1	5.0	5.4
²⁴¹ Am	-4.8	-8.3	10.9	-	18.5	12.2	0.5	4.8
^{242m} Am	-	-	-	-	8.0	5.7	-21.3	-15.5
²⁴² Cm	21.2	34.5	46.3	34.5	34.8	25.0	8.0	13.4
²⁴⁴ Cm	-30.2	-23.4	-3.8	-13.0	14.4	16.3	-13.7	-7.2
¹⁰⁶ Ru	-	-	-	-	49.7	61.9	39.1	56.9
¹³⁴ Cs	-	-	-	-	10.4	18.5	2.3	11.8
¹³⁷ Cs	-6.4	-6.4	-2.5	-3.1	3.6	4.9	2.6	4.1
¹⁴⁴ Ce	-	-	-	-	90.7	100.6	78.8	99.2
¹⁴³ Nd	1.3	0.8	1.8	0.6	0.1	-0.1	0.3	-0.6
¹⁴⁴ Nd	0.2	-0.6	0.5	-0.6	-1.2	-1.3	-0.8	-1.7
¹⁴⁵ Nd	1.1	0.7	1.6	0.4	0.2	-0.2	0.3	-0.4
¹⁴⁶ Nd	0.8	0.6	1.4	0.4	-0.3	-0.1	0.3	-0.3
¹⁴⁸ Nd	0.8	0.7	1.5	0.7	-0.1	0.0	-0.1	-0.1
¹⁵⁰ Nd	-0.6	-0.7	0.0	-0.1	0.7	0.7	1.5	0.2
¹⁵⁴ Eu	-	-	-	-	6.0	6.9	-1.4	4.7
¹⁵⁵ Eu	-	-	-	-	-42.4	-39.3	-44.4	-43.6

Table 23 (continued)

Assembly ID Fuel pin ID or positions Axial height, cm Burnup, GWd/MTU	A-20 C3 141.8 2.65	A-20 C3 117.4 5.09	A-20 C3 92.9 6.08	A-20 C3 56.2 6.04	A-20 C3 31.8 5.06	A-20 C3 7.3 2.16	A-20 E2 117.4 5.60	A-20 E2 31.8 5.38	Average	Std. Deviation
²³⁴ U	0.5	3.4	4.4	-2.9	-2.3	-1.8	-0.2	0.0	0.3	2.2
²³⁵ U	-0.8	-0.8	-1.7	-0.5	-0.4	-0.3	-0.7	0.0	-0.4	0.9
²³⁶ U	-1.4	0.4	-0.6	-0.8	-0.3	-0.2	0.6	-1.7	0.5	1.6
²³⁸ U	0.0	0.0	0.0	0.0	0.0	0.0	0.0	0.0	0.0	0.0
²³⁸ Pu	-16.8	-25.4	-26.2	-27.3	-20.6	-19.7	-13.2	-16.9	-11.5	17.8
²³⁹ Pu	1.2	-7.4	-8.3	-9.3	-4.5	-2.6	-1.5	-0.9	-1.9	4.3
²⁴⁰ Pu	2.4	-3.3	-4.4	-5.8	-1.9	-1.0	2.4	0.2	0.6	3.8
²⁴¹ Pu	-5.1	-17.3	-18.0	-20.1	-13.8	-10.6	-8.3	-9.1	-6.8	8.6
²⁴² Pu	-2.9	-14.5	-13.5	-17.5	-11.6	-10.6	-3.1	-6.6	-2.0	14.1
²³⁷ Np	-3.6	-11.2	-8.8	-9.9	-3.9	-9.7	-1.5	-5.1	-1.9	7.8
²⁴¹ Am	4.9	-8.6	-10.1	-11.1	-7.7	-3.8	2.2	-3.5	-0.6	8.8
^{242m} Am	-7.7	88.1	-9.5	-36.9	14.8	-37.5	36.0	3.0	2.3	34.3
²⁴² Cm	8.1	-5.8	-8.8	-9.0	-5.0	4.1	11.4	3.8	13.5	17.5
²⁴⁴ Cm	-31.1	-43.0	-37.6	-36.7	-28.1	-57.9	-17.4	-26.1	-21.2	19.8
¹⁰⁶ Ru	39.6	37.6	39.4	44.0	56.2	50.9	43.1	55.7	47.8	8.4
¹³⁴ Cs	7.9	-1.8	-2.4	3.4	8.9	8.0	4.0	8.4	6.6	5.9
¹³⁷ Cs	5.4	5.0	4.5	6.4	6.5	4.7	3.9	4.0	2.3	4.3
¹⁴⁴ Ce	80.4	92.0	89.3	101.0	114.7	108.1	87.0	103.6	95.5	10.9
¹⁴⁵ Nd	0.4	0.3	0.7	0.3	0.4	0.4	0.3	-0.1	0.4	0.6
¹⁴⁴ Nd	0.0	0.1	0.3	-0.1	-0.1	-0.1	-0.4	-1.2	-0.4	0.7
¹⁴⁵ Nd	0.4	0.5	0.5	0.3	0.2	0.2	0.3	0.2	0.4	0.5
¹⁴⁶ Nd	0.3	-0.2	-0.2	-0.3	0.0	0.6	-0.2	-0.1	0.2	0.5
¹⁴⁸ Nd	0.5	0.1	-0.1	-0.1	0.1	0.3	0.1	-0.1	0.3	0.5
¹⁵⁰ Nd	-0.3	-1.6	-1.5	-1.5	0.6	-0.5	-0.4	-0.5	-0.3	0.9
¹⁵⁴ Eu	1.5	-11.7	-13.1	-7.5	-3.7	-2.0	-5.7	-2.5	-2.4	6.5
¹⁵⁵ Eu	-	-	-	-	-	-	-43.3	-42.7	-42.6	0.4

^a(Calculated/measured - 1) × 100%.

^bUsing SAS2H/ORIGEN-S analysis sequence and the 44-group cross-section library of SCALE-4.3.

- A-14/mid, 129.6cm, 3.30 GWd/MTU
- A-14/mid, 44.0cm, 4.04 GWd/MTU
- ◇ A-18/mid, 129.6cm, 2.71 GWd/MTU
- × A-18/mid, 80.7cm, 4.25 GWd/MTU
- + A-20/A1, 117.4cm, 7.01 GWd/MTU
- △ A-20/A3, 31.8cm, 6.15 GWd/MTU
- A-20/A6, 117.4cm, 6.95 GWd/MTU
- A-20/A6, 44.0cm, 6.51 GWd/MTU
- ◆ A-20/C3, 141.8cm, 2.65 GWd/MTU
- ▲ A-20/C3, 117.4cm, 5.09 GWd/MTU
- ▼ A-20/C3, 92.9cm, 6.08 GWd/MTU
- ⊞ A-20/C3, 56.2cm, 6.04 GWd/MTU
- ⊠ A-20/C3, 31.8cm, 5.06 GWd/MTU
- ⊞ A-20/C3, 7.3cm, 2.16 GWd/MTU
- A-20/E2, 117.4cm, 5.60 GWd/MTU
- ▽ A-20/E2, 31.8cm, 5.38 GWd/MTU

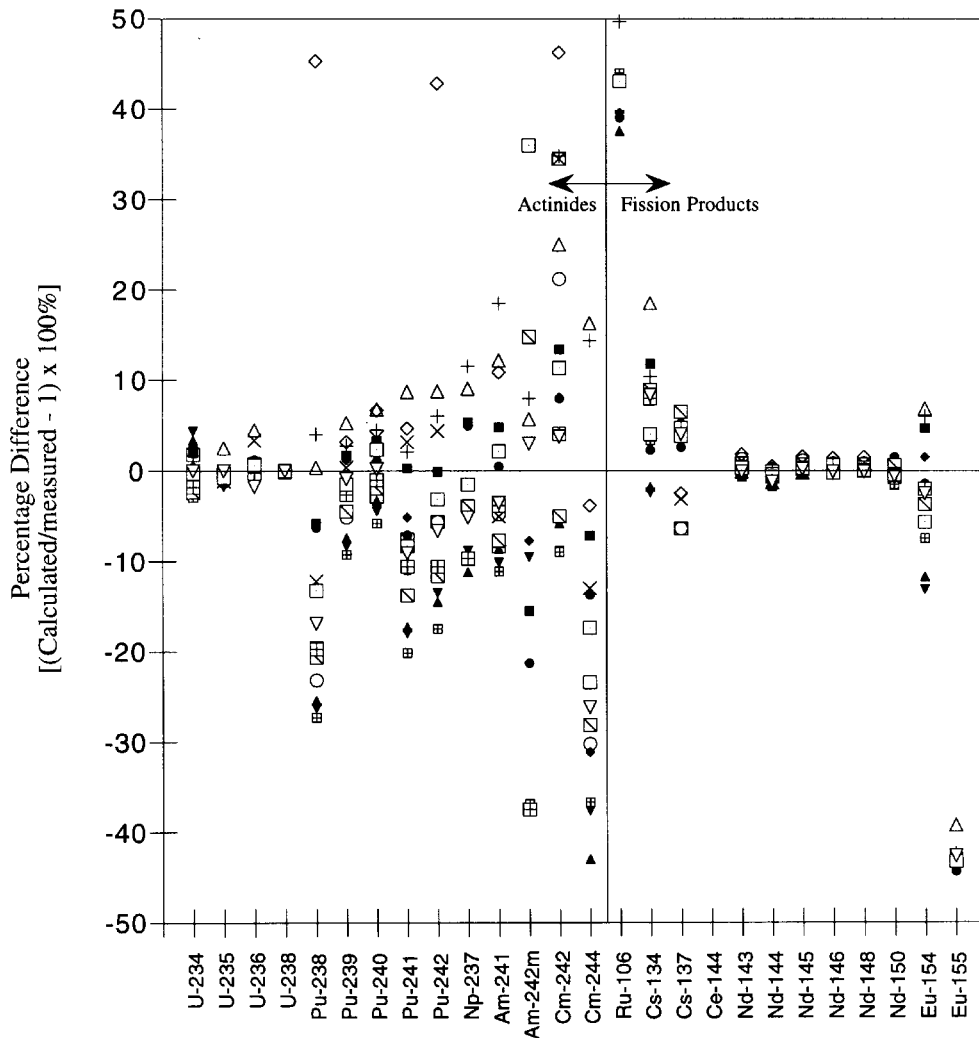

Fig. 8. Percentage differences between measured and calculated results for JPDR fuel samples.

3.4 SUMMARY OF ISOTOPIC COMPARISON RESULTS

Average percentage differences between measured and computed isotopic concentrations combined for all three of the reactors (Cooper, Gundremmingen, and JPDR) are presented in Table 24. This table also provides the number of samples used to calculate the average for each isotopic and the minimum and maximum percentage differences of the cases. These results are also illustrated in Fig. 9. This figure shows all the percentage differences determined for each of the three reactors. All data points from Tables 18, 20, and 23 are shown but are not identified by specific sample. Instead, data points are represented by unique symbols for each reactor type to highlight any differences that might occur as a function of reactor design or operation. Results for ^{126}Sn are not shown in this figure because the magnitude of the error places it off the plot scale.

Statistical estimates of the standard deviation of the sample set of calculated results are given in Table 24 for each nuclide. However, the appropriateness of this statistic requires a normal distribution of results, which was not tested here. However, to test the consistency of the standard deviations calculated for each reactor type, the standard deviations are plotted in bar format for each of the three reactors in Fig. 10. Comparisons are made only for those nuclides for which assays were performed in more than one reactor type. This figure indicates that, for the most part, deviations in the calculated-to-measured ratios are consistent among the three reactor types. This in turn indicates that the three sets of results are statistically similar, and may be grouped together into a single set.

Table 24. Summary of percentage differences^a between measured and computed composition in this BWR validation study as averages and spreads

No.	Nuclide	No. of cases	44GROUPNDF5 data			Standard deviation
			Average	Max	Min	
1	⁷⁹ Se	6	23.6	28.1	20.8	2.6
2	⁹⁰ Sr	6	8.9	10.8	5.9	1.9
3	⁹⁹ Tc	6	12.1	14.6	7.0	3.1
4	¹⁰⁶ Ru	12	47.8	61.9	37.6	8.4
5	¹²⁶ Sn	6	205.2	218.4	195.4	8.2
6	¹³⁴ Cs	20	0.9	18.5	-23.4	11.4
7	¹³⁵ Cs	6	5.1	10.4	-6.5	6.2
8	¹³⁷ Cs	30	1.5	17.3	-13.1	5.9
9	¹⁴⁴ Ce	12	95.5	114.7	78.8	10.9
10	¹⁴³ Nd	16	0.4	1.8	-0.6	0.6
11	¹⁴⁴ Nd	16	-0.4	0.5	-1.7	0.7
12	¹⁴⁵ Nd	16	0.4	1.6	-0.4	0.5
13	¹⁴⁶ Nd	16	0.2	1.4	-0.3	0.5
14	¹⁴⁸ Nd	24	-0.5	1.5	-4.4	1.3
15	¹⁵⁰ Nd	16	-0.3	1.5	-1.6	0.9
16	¹⁵⁴ Eu	20	-7.8	6.9	-32.3	11.0
17	¹⁵⁵ Eu	6	-42.6	-39.3	-44.4	1.8
18	²³⁴ U	22	-0.2	4.4	-6.1	2.6
19	²³⁵ U	30	-2.0	4.0	-11.7	3.3
20	²³⁶ U	30	-1.2	4.5	-7.8	2.7
21	²³⁸ U	30	-0.1	0.2	-1.5	0.4
22	²³⁷ Np	18	-1.1	17.3	-11.2	8.7
23	²³⁸ Pu	30	-7.0	45.3	-27.3	16.3
24	²³⁹ Pu	30	-2.1	8.8	-17.3	6.0
25	²⁴⁰ Pu	30	-0.9	6.9	-11.1	4.8
26	²⁴¹ Pu	30	-4.5	17.1	-20.1	9.3
27	²⁴² Pu	30	0.5	42.9	-17.5	12.6
28	²⁴¹ Am	22	4.1	28.4	-11.1	11.5
29	^{242m} Am	12	2.3	88.1	-37.5	34.3
30	²⁴² Cm	16	13.5	46.3	-9.0	17.5
31	²⁴³ Cm.. ²⁴⁴ Cm	6	13.5	41.4	1.0	19.4
32	²⁴⁴ Cm	24	-19.4	16.3	-57.9	15.5

^a(Calculated/measured – 1) × 100%.

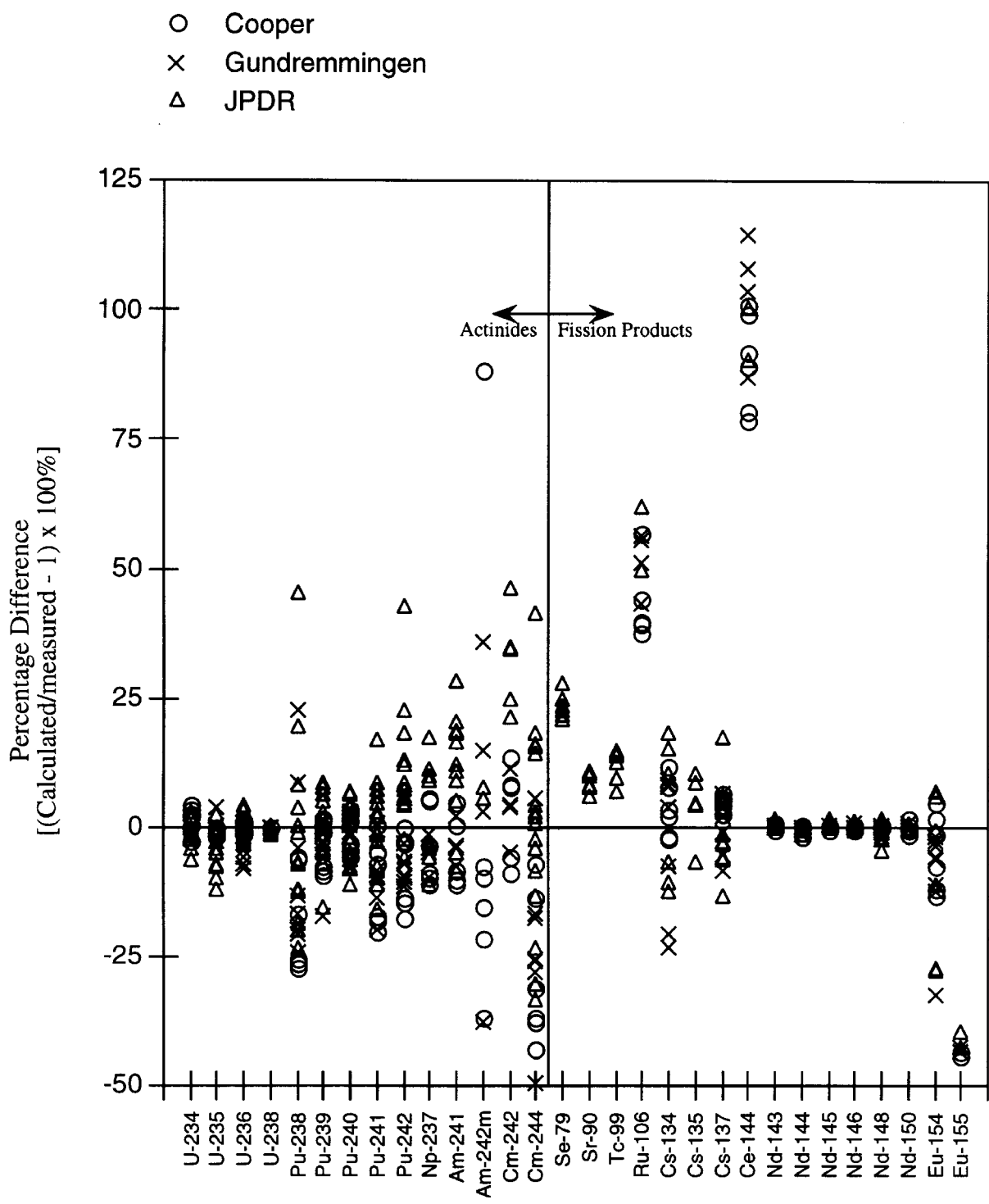

Fig. 9. Percentage differences between measured and calculated results for all fuel samples.

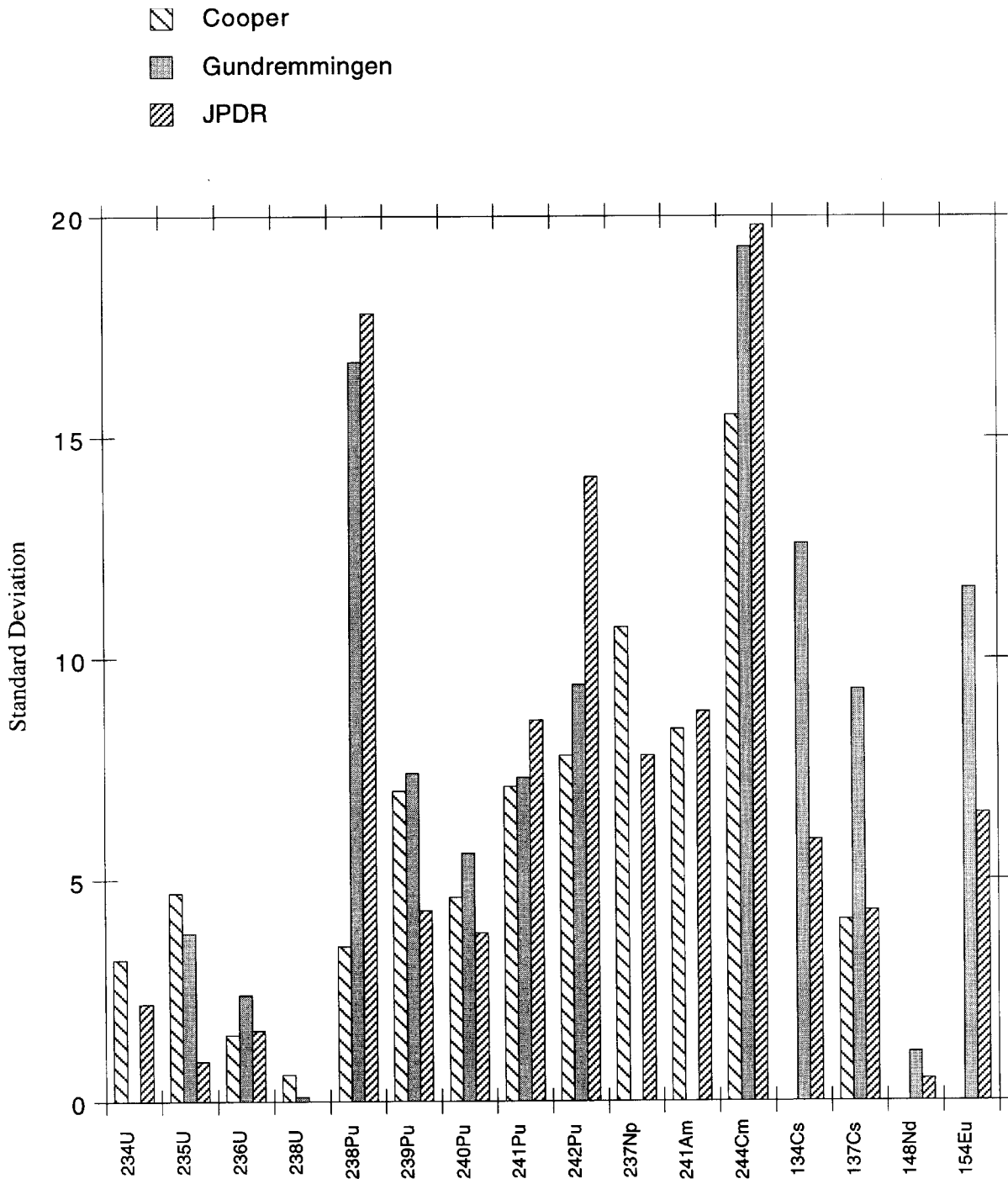

Fig. 10. Standard deviation of isotopic prediction results by reactor type.

4. SUMMARY

Because of the complexity of BWR core dynamics relative to PWR operation, it is generally accepted that isotopic predictions for BWR spent fuel will generally have greater associated uncertainties than for PWR spent fuel. Not only are BWR assembly and core layouts more heterogeneous in terms of material content both radially and axially, but other control procedures generally employed in BWR operation result in variable axial power and neutron spectrum profiles.

Results presented herein demonstrate that isotopic concentrations can be predicted by SAS2H with reasonable accuracy relative to measured data, even with the complexities of the BWR design and operation, for the classes of reactor fuel analyzed. It may be possible to improve estimates of BWR spent fuel contents by refining the modeling approach. For example, to address the effect of variable enrichments within an assembly design, it would be necessary to repeat these analyses using more detailed multidimensional transport methods to obtain a better estimate of the local neutron flux at the location of the fuel sample. A set of scoping calculations were performed to estimate the effect of variations in moderator density on depletion calculations. The results are summarized in Appendix H. To address the effect of moderator density variations more fully, it would be necessary to use more refined methods to estimate the axial moderator density.

More important than the need to refine the current computational approach is the need to extend the set of computational comparisons to measured data. Not only are there few if any measurements for important fission product nuclides, but also the number of different reactor designs and operational patterns are poorly represented by the small subset of measurements presented in this report. Furthermore, although the measured data from JPDR have value, especially for low-burnup fuel located near the ends of reactor fuel rods, the number of measurements of JPDR fuel samples relative to the other samples may introduce a bias in results due to conditions unique in the JPDR design. Finally, from a statistical point of view, it is desirable to use as many data points as possible to ensure the best possible estimate of bias and uncertainty for predicted spent fuel isotopic concentrations.

5. REFERENCES

1. *SCALE. A Modular Code System for Performing Standardized Computer Analyses for Licensing Evaluation*, NUREG/CR-0200, Rev. 5 (ORNL/NUREG/CSD-2/R5), Vols. I–III, (March 1997). Available from Radiation Safety Information Computational Center, Oak Ridge National Laboratory, as CCC-545.
2. T. L. Sanders and R. M. Westfall, “Feasibility and Incentives for Burnup Credit in Spent Fuel Transport Casks,” *Nucl. Sci. Eng.* **104** (1990).
3. M. D. DeHart, *Sensitivity and Parametric Evaluations of Significant Aspects of Burnup Credit for PWR Spent Fuel Packages*, ORNL/TM-12973, Lockheed Martin Energy Research Corp., Oak Ridge Natl. Lab., May 1996.
4. S. M. Bowman, M. D. DeHart, and C. V. Parks, "Validation of SCALE-4 for Burnup Credit Applications," *Nucl. Tech.* **110** (1995).
5. M. D. DeHart and C. V. Parks, “Issues Related to Criticality Safety Analysis for Burnup Credit,” *Fifth International Conference on Nuclear Criticality Safety*, Albuquerque, N.M., September 17–21, 1995.
6. “American National Standard for Nuclear Criticality Safety in Operations with Fissionable Materials Outside Reactors,” ANSI/ANS-8.1-1983, American Nuclear Society, 1983.
7. M. D. DeHart, O. W. Hermann, and C. V. Parks, “Validation of a Method for Prediction of Isotopic Concentrations in Burnup Credit Applications,” *Fifth International Conference on Nuclear Criticality Safety*, Albuquerque, N.M., September 17–21, 1995.

8. O. W. Hermann, S. M. Bowman, M. C. Brady, and C. V. Parks, *Validation of the SCALE System for PWR Spent Fuel Isotopic Composition Analyses*, ORNL/TM-12667, Martin Marietta Energy Systems, Inc., Oak Ridge Natl. Lab., 1995.
9. M. D. DeHart and O. W. Hermann, *An Extension of the Validation of SCALE (SAS2H) Isotopic Predictions for PWR Spent Fuel*, ORNL/TM-13317, Lockheed Martin Energy Research Corp., Oak Ridge Natl. Lab., September 1996.
10. R. J. Guenther et al., *Characterization of Spent Fuel Approved Testing Material - ATM-105*, PNL-5109-105, Pacific Northwest Laboratory, 1991.
11. Y. Naito, M. Kurosawa, and T. Kaneko, *Data Book of the Isotopic Composition of Spent Fuel in Light Water Reactors*, JAERI-M 94-034, Japan Atomic Energy Research Institute, 1994.
12. P. Barbero et al., *Post-Irradiation Analysis of the Gundremmingen BWR Spent Fuel*, EUR6301en, Joint Research Center Ispra and Karlsruhe Establishments, 1979.
13. *The Evaluated Nuclear Data File, Versions IV, V, and VI (ENDF/B-IV, V, and VI)*, maintained by the National Data Center at Brookhaven National Laboratory.
14. M. D. DeHart and S. M. Bowman, *Validation of the SCALE Broad Structure 44-Group ENDF/B-V Cross-Section Library for Use in Criticality Safety Analyses*, NUREG/CR-6102 (ORNL/TM-12460), U.S. Nuclear Regulatory Commission, 1994.
15. R. Q. Wright, "Fission Product Evaluations for ENDF/B-VI," *Trans. Am. Nucl. Soc.* **61**, 398–99 (1990).

16. O. W. Hermann, C. V. Parks, and J. P. Renier, *Technical Support for a Proposed Decay Heat Guide Using SAS2H/ORIGEN-S Data*, NUREG/CR-5625 (ORNL-6698), U.S. Nuclear Regulatory Commission, 1994.
17. U.S. Department of Energy, *Characteristics of Potential Repository Wastes*, DOE/RW-0184-R1, Vol. 1, Oak Ridge Natl. Lab., July 1992.
18. M. A. McKinnon, C. M. Heeb, and J. M. Creen, *Decay Heat Measurements and Predictions of BWR Spent Fuel*, EPRI NP-4619, Electric Power Research Institute, June 1986.
19. O. W. Hermann et al., *Multicode Comparison of Selected Source Term Computer Codes*, ORNL/CSD/TM-251, Martin Marietta Energy Systems, Inc., Oak Ridge Natl. Lab., April 1989.

APPENDIX A

DESCRIPTION OF THE SCALE SAS2H DEPLETION APPROACH

SCALE is a well-established code system that has been widely used in away-from-reactor (AFR) applications for spent fuel characterization via the SAS2H analysis sequence.^{A.1} SAS2H is a multicode sequence that determines the isotopic composition of spent fuel using the ORIGEN-S code^{A.2} for depletion and decay calculations and a 1-D neutronics model of a fuel assembly to prepare burnup-dependent cross sections for ORIGEN-S. Isotopic concentrations used in the subsequent spent fuel criticality calculations are based on the results of SAS2H calculations.

The SAS2H control module was originally developed for the SCALE code system to provide a sequence that generated radiation source terms for spent fuel and subsequently to utilize these sources with a 1-D shielding analysis of a shipping cask. However, in addition to the calculation of radiation source terms, SAS2H is now often used to obtain decay heat and depleted fuel isotopics. Within the scope of validation activities described in this report, SAS2H is used solely for the prediction of burnup-depleted isotopics in spent fuel.

Six different modules are invoked by the SAS2H sequence for performing a complete fuel depletion analysis. The SCALE-4 system driver provides automated data handling and code execution for each step of the process. This procedure begins with the SCALE Material Information Processor,^{A.3} which generates number densities and related information, prepares geometry data for resonance self-shielding and flux-weighting cell calculations, and creates data input files for the cross-section processing codes. BONAMI^{A.4} applies the Bondarenko method of resonance self-shielding for nuclides which have Bondarenko data included in the cross-section library. NITAWL-II^{A.5} performs Nordheim resonance self-shielding corrections for nuclides that have resonance parameters included with their cross-section data. XSDRNPM^{A.6} is a 1-D discrete-ordinates code that performs radiation transport calculations based on geometric data passed to it by SAS2H and produces cell-weighted cross sections for fuel depletion calculations. The COUPLE code^{A.7} updates cross-section constants included on the ORIGEN-S nuclear data library with data from the cell-weighted cross-section library produced by XSDRNPM. COUPLE also uses the XSDRNPM-computed weighting spectrum to update nuclide cross sections for remaining nuclides. Finally, the

ORIGEN-S code is used to perform nuclide generation and depletion calculations for a specified reactor fuel history.

The process used by SAS2H in calculation of spent fuel isotopics is illustrated schematically in Fig. A.1. The calculation starts with input-specified data that describe a fuel assembly as it is initially loaded into a reactor. The initial composition, average temperatures, geometry, and time-dependent specific power of the fuel assembly are required. The SAS2H sequence performs 1-D neutron transport analysis of the reactor fuel assembly using XSDRNPM and a two-part procedure with two separate unit-cell-lattice models. The first model (Path A of Fig. A.1) is a unit fuel-pin cell from which cell-weighted cross sections are obtained. The second model (Path B of Fig. A.1) represents a larger unit cell (e.g., an assembly) within an infinite lattice. The larger unit cell zones can be structured for different assembly designs to account for assembly-specific attributes (i.e., water holes, burnable poison rods, etc.). Problem-dependent resonance self-shielding of cross sections is performed prior to each XSDRNPM calculation using the BONAMI and NITAWL-II codes. The neutron flux spectrum obtained from the second (assembly) unit-cell model is used to determine the appropriate nuclide cross sections for the burnup-dependent fuel composition. The cross sections derived from XSDRNPM calculations at each time step are used in an ORIGEN-S point-depletion computation that produces the burnup-dependent fuel compositions to be used in the next spectrum calculation. This sequence is repeated in user-specified burnup steps for a complete assembly operating history. The buildup and decay of nuclides in the fuel assembly is then computed by ORIGEN-S in a final pass based on the cooling time (i.e., the period of time after final exposure time) of the assembly. Note that ORIGEN-S calculations have no spatial dependence. The neutron flux used to produce the ORIGEN-S cross sections is based on a radial average of an infinitely long uniform assembly with characteristics per input specifications. These specifications (e.g., burnup, specific power, moderator temperature, etc.) can be representative of any axial location along the fuel assembly or an axial average of the fuel assembly.

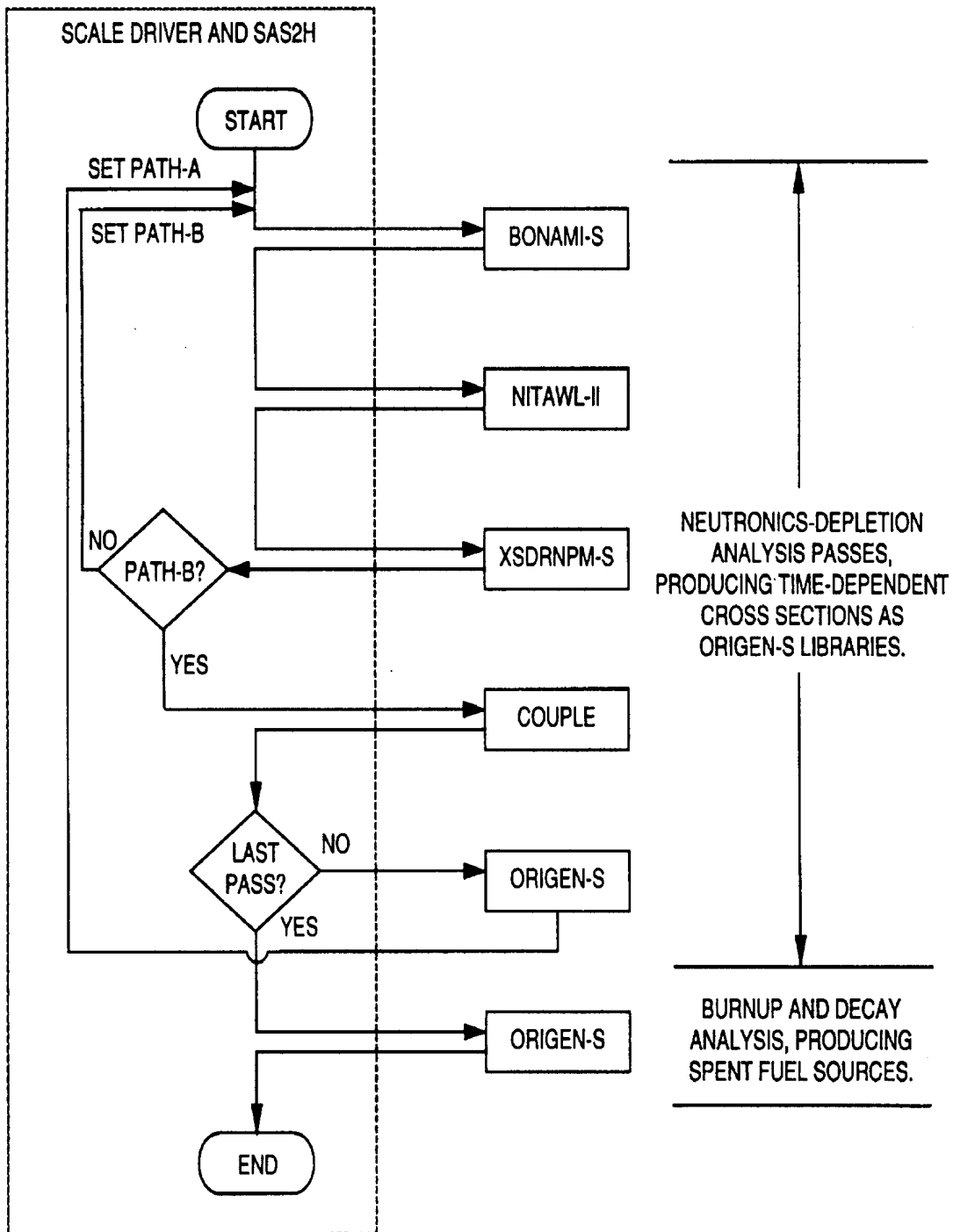

Fig. A.1. Flow path invoked in SAS2H depletion and decay sequences.

More than 1000 nuclides are tracked by ORIGEN-S during depletion and decay calculations. (Note that ORIGEN-S tracks all decay chains but does not account for the loss of volatile isotopes; however, any released nuclides represent an insignificant fraction of the total fission-product inventory, and their inclusion should have an insignificant effect on the isotopic calculations.) In the current work, burnup-dependent cross sections were processed by SAS2H only for the select set of user-specified nuclides listed in Table A.1. These nuclides are consistent with the set of nuclides found to be significant to the depletion analyses in prior studies^{A.8,A.9} for validation of the use of SCALE/SAS2H to predict isotopic compositions of PWR spent fuel. Cross sections for remaining isotopes are obtained from the ORIGEN-S one-group LWR library and are adjusted with burnup using ORIGEN-S spectral parameters (THERM, RES, and FAST)^{A.2} calculated using fluxes determined by XSDRNPM. The ORIGEN-S one-group LWR library available in SCALE-4.3 has been updated to use cross sections from the SCALE-4.3 27-group burnup library for all of the approximately 200 nuclides in that library. The update was performed by extracting one-group cross sections from the output of a low-burnup LWR-type fuel.

Table A.1. Nuclides updated by SAS2H

²³⁴ U ^a	²³⁵ U ^a	²³⁶ U ^a	²³⁸ U ^a	²³⁷ Np ^a
²³⁸ Pu ^a	²³⁹ Pu ^a	²⁴⁰ Pu ^a	²⁴¹ Pu ^a	²⁴² Pu ^a
²⁴¹ Am ^a	^{242m} Am ^{a,b}	²⁴³ Am ^a	²⁴² Cm ^{a,b}	²⁴³ Cm ^{a,b}
²⁴⁴ Cm ^a	¹⁰ B	¹¹ B	¹⁶ O	⁹⁴ Zr
⁹⁵ Nb	⁹⁵ Mo	⁹⁹ Tc	¹⁰⁶ Ru	¹⁰³ Rh
¹⁰⁵ Rh	¹²⁶ Sn	¹³¹ Xe	¹³⁵ Xe ^a	¹³³ Cs ^a
¹³⁴ Cs	¹³⁵ Cs	¹³⁷ Cs	¹⁴⁴ Ce	¹⁴³ Pr
¹⁴³ Nd	¹⁴⁴ Nd	¹⁴⁵ Nd	¹⁴⁶ Nd	¹⁴⁷ Nd
¹⁴⁸ Nd	¹⁵⁰ Nd	¹⁴⁷ Pm	¹⁴⁸ Pm	¹⁴⁹ Pm
¹⁴⁷ Sm	¹⁴⁸ Sm	¹⁴⁹ Sm	¹⁵⁰ Sm	¹⁵¹ Sm
¹⁵² Sm	¹⁵¹ Eu	¹⁵³ Eu	¹⁵⁴ Eu	¹⁵⁵ Eu

^aAutomatically updated by SAS2H if nuclide cross sections are in the SCALE master library requested.

^bNuclide included in the 44-group library but not in the 27-group burnup library.

The quantity of a light element contained in the fuel assembly, if not included in the model as a material in a mixture input to SAS2H, may be input as kilograms of the element per assembly, per metric ton U (MTU), or per metric ton UO₂ (MT UO₂). The units should correspond to the type of units used in the radiochemical assay measurements (i.e., either per gram U, or per gram UO₂). The generic quantities of significant light elements for BWR fuel^{A.10} used in this study are given in Table A.2.

Table A.2. Element contents^a from clad, structure, and moderator for a generic BWR

Element	kg/MTU	kg/MT UO ₂
H	16.4	14.5
O	265.0	236.0
Cr	2.4	2.1
Mn	0.15	0.13
Fe	6.6	5.8
Ni	2.4	2.1
Zr	516.0	455.0
Sn	8.7	7.7

^aCalculated from data and factors in ref. A.10.

A.1 References

- A.1 O. W. Hermann and C. V. Parks, "SAS2H: A Coupled One-Dimensional Depletion and Shielding Analysis Code," Sect. S2 of *SCALE: A Modular Code System for Performing Standardized Computer Analyses for Licensing Evaluation*, NUREG/CR-0200, Rev. 4 (ORNL/NUREG/CSD-2/R4), Vols. I, II, and III (April 1995). Available from Radiation Shielding Information Center as CCC-545.
- A.2 O. W. Hermann and R. M. Westfall, "ORIGEN-S: A SCALE System Module to Calculate Fuel-Depletion, Actinide Transmutation, Fission Product Buildup and Decay, and Associated Radiation Source Terms," Sect. F7 of *SCALE: A Modular Code System for Performing Standardized Computer Analyses for Licensing Evaluation*, NUREG/CR-0200, Rev. 4 (ORNL/NUREG/CSD-2/R4), Vols. I, II, and III (April 1995). Available from Radiation Shielding Information Center as CCC-545.

- A.3 N. F. Landers et al., “The Material Information Processor for SCALE,” Sect. M7 of *SCALE: A Modular Code System for Performing Standardized Computer Analyses for Licensing Evaluation*, NUREG/CR-0200, Rev. 4 (ORNL/NUREG/CSD-2/R4), Vols. I, II, and III (April 1995). Available from Radiation Shielding Information Center as CCC-545.
- A.4 N. M. Greene, “BONAMI: Resonance Self-Shielding by the Bondarenko Method,” Sect. F1 of *SCALE: A Modular Code System for Performing Standardized Computer Analyses for Licensing Evaluation*, NUREG/CR-0200, Rev. 4 (ORNL/NUREG/CSD-2/R4), Vols. I, II, and III (April 1995). Available from Radiation Shielding Information Center as CCC-545.
- A.5 N. M. Greene, “NITAWL-II: SCALE System Module for Performing Resonance Shielding and Working Library Production,” Sect. F2 of *SCALE: A Modular Code System for Performing Standardized Computer Analyses for Licensing Evaluation*, NUREG/CR-0200, Rev. 4 (ORNL/NUREG/CSD-2/R4), Vols. I, II, and III (April 1995). Available from Radiation Shielding Information Center as CCC-545.
- A.6 N. M. Greene and L. M. Petrie, “XSDRNPM: A One-Dimensional Discrete-Ordinates Code for Transport Analysis,” Sect. F3 of *SCALE: A Modular Code System for Performing Standardized Computer Analyses for Licensing Evaluation*, NUREG/CR-0200, Rev. 4 (ORNL/NUREG/CSD-2/R4), Vols. I, II, and III (April 1995). Available from Radiation Shielding Information Center as CCC-545.
- A.7 O. W. Hermann, “COUPLE: SCALE System Module to Process Problem-Dependent Cross Sections and Neutron Spectral Data for ORIGEN-S Analyses,” Sect. F6 of *SCALE: A Modular Code System for Performing Standardized Computer Analyses for Licensing Evaluation*, NUREG/CR-0200, Rev. 4 (ORNL/NUREG/CSD-2/R4), Vols. I, II, and III (April 1995). Available from Radiation Shielding Information Center as CCC-545.
- A.8 O. W. Hermann, S. M. Bowman, M. C. Brady, and C. V. Parks, *Validation of the SCALE System for PWR Spent Fuel Isotopic Composition Analyses*, ORNL/TM-12667, Martin Marietta Energy Systems, Inc., Oak Ridge Natl. Lab., 1995.
- A.9 M. D. DeHart and O. W. Hermann, *An Extension of the Validation of SCALE (SAS2H) Isotopic Predictions for PWR Spent Fuel*, ORNL/TM-12496, Lockheed Martin Energy Research Corp., Oak Ridge Natl. Lab. (to be published).
- A.10 A. G. Croff et al., *Revised Uranium-Plutonium Cycle PWR and BWR Models for the ORIGEN Computer Code*, ORNL/TM-6051, Union Carbide Corp., Nucl. Div., Oak Ridge Natl. Lab., 1978.

APPENDIX B

INPUT LISTINGS FOR COOPER BWR SAS2H DEPLETION CALCULATIONS

```
=sas2      parm='halt07,skipshipdata'
sas2 cooper bwr, assy cz346, rod add2966 cut-b, 18.96 gwd/mtu b5 7/97 4.3r
'
'-----
'
'   mixtures of fuel-pin-unit-cell:
'
44group      latticecell
uo2  1 den=9.73      1  840  92234  0.026  92235  2.939  92236  0.014
      92238 97.021      end
co-59  3 0 1-20 558  end
zr-94  1 0 1-20 840  end
nb-95  1 0 1-20 840  end
mo-95  1 0 1-20 840  end
tc-99  1 0 1-20 840  end
rh-103 1 0 1-20 840  end
rh-105 1 0 1-20 840  end
ru-106 1 0 1-20 840  end
sn-126 1 0 1-20 840  end
xe-131 1 0 1-20 840  end
cs-134 1 0 1-20 840  end
cs-135 1 0 1-20 840  end
cs-137 1 0 1-20 840  end
pr-143 1 0 1-20 840  end
nd-143 1 0 1-20 840  end
ce-144 1 0 1-20 840  end
nd-144 1 0 1-20 840  end
nd-145 1 0 1-20 840  end
nd-146 1 0 1-20 840  end
nd-147 1 0 1-20 840  end
pm-147 1 0 1-20 840  end
sm-147 1 0 1-20 840  end
nd-148 1 0 1-20 840  end
pm-148 1 0 1-20 840  end
sm-148 1 0 1-20 840  end
pm-149 1 0 1-20 840  end
sm-149 1 0 1-20 840  end
nd-150 1 0 1-20 840  end
sm-150 1 0 1-20 840  end
sm-151 1 0 1-20 840  end
eu-151 1 0 1-20 840  end
sm-152 1 0 1-20 840  end
eu-153 1 0 1-20 840  end
eu-154 1 0 1-20 840  end
eu-155 1 0 1-20 840  end
'   need the following to use endf/b5 library:
zirc2  2 1 620  end
'
h2o  3 den=0.3446      1  558  end
'
'-----
'
'   mixtures of larger-unit-cell:
'
uo2  5 den=9.73      1  840  92234  0.026  92235  2.939  92236  0.014
      92238 97.021      end
arbm-gdburn  9.73      7 0 1 1
              64154  2.18  64155 14.80  64156 20.47
```

```

        64157 15.65  64158 24.84  64160 21.86
        8016 150.0  5   0.034  840  end
        ....above is 3.4 wt % gadolinium (as gd2-ox3) in the
        burnable poison pins of bwr assembly....
'
'   need the following to use endf/b5 library:
zirc2  7 1 558  end
'
'   ....above is zircalloy casing around assembly
h2o    11  den=0.7627  1   552  end
'
'   ....above is channel moderator at higher density
end comp
'
' -----
'
'   fuel-pin-cell geometry:
'
squarepitch  1.875  1.242  1 3  1.430  2  end
'
' -----
'
'   assembly and cycle parameters:
'
'   printlevel=4  lightel=8  inplevel=2  numzones=4  end
npin/assm=49  fuelngth=1731.1  ncycles=7  nlib/cyc=1
printlevel=4  lightel=8  inplevel=2  numzones=6  end
5  0.621  2  0.715  3  1.058
500 3.311  7 3.412  11 3.845
power=10.275 burn=268.67  down=0.0  end
power=10.275 burn=268.67  down=0.0  end
power=10.275 burn=268.67  down=60.0  end
power=10.203 burn=306.0  down=31.0  end
power=10.039 burn=165.0  down=800.0  end
power= 6.165 burn=317.0  down=49.0  end
power= 4.894 burn=347.0  down=1954.0  end
    h  14.5    o  236    cr  2.1
    mn  0.13   fe  5.8    ni  2.1
    zr  455    sn  7.7
'
' -----
end

=sas2      parm='halt07,skipshipdata'
sas2 cooper bwr, assy cz346, rod add2966 cut-k, 33.07 gwd/mtu b5 7/97 4.3r
'
' -----
'
'   mixtures of fuel-pin-unit-cell:
'
44group      latticecell
uo2  1  den=9.73    1  840  92234  0.026  92235  2.939  92236  0.014
      92238  97.021  end
co-59  3 0 1-20 558  end
zr-94  1 0 1-20 840  end
nb-95  1 0 1-20 840  end
mo-95  1 0 1-20 840  end
tc-99  1 0 1-20 840  end
rh-103 1 0 1-20 840  end
rh-105 1 0 1-20 840  end
ru-106 1 0 1-20 840  end
sn-126 1 0 1-20 840  end
xe-131 1 0 1-20 840  end
cs-134 1 0 1-20 840  end

```

```

cs-135 1 0 1-20 840 end
cs-137 1 0 1-20 840 end
pr-143 1 0 1-20 840 end
nd-143 1 0 1-20 840 end
ce-144 1 0 1-20 840 end
nd-144 1 0 1-20 840 end
nd-145 1 0 1-20 840 end
nd-146 1 0 1-20 840 end
nd-147 1 0 1-20 840 end
pm-147 1 0 1-20 840 end
sm-147 1 0 1-20 840 end
nd-148 1 0 1-20 840 end
pm-148 1 0 1-20 840 end
sm-148 1 0 1-20 840 end
pm-149 1 0 1-20 840 end
sm-149 1 0 1-20 840 end
nd-150 1 0 1-20 840 end
sm-150 1 0 1-20 840 end
sm-151 1 0 1-20 840 end
eu-151 1 0 1-20 840 end
sm-152 1 0 1-20 840 end
eu-153 1 0 1-20 840 end
eu-154 1 0 1-20 840 end
eu-155 1 0 1-20 840 end
' need the following to use endf/b5 library:
zirc2 2 1 620 end
'
h2o 3 den=0.4705 1 558 end
'
' -----
'
' mixtures of larger-unit-cell:
'
uo2 5 den=9.73 1 840 92234 0.026 92235 2.939 92236 0.014
      92238 97.021 end
arbm-gdburn 9.73 7 0 1 1
      64154 2.18 64155 14.80 64156 20.47
      64157 15.65 64158 24.84 64160 21.86
      8016 150.0 5 0.034 840 end
'
' ....above is 3.4 wt % gadolinium (as gd2-ox3) in the
' burnable poison pins of bwr assembly....
'
' need the following to use endf/b5 library:
zirc2 7 1 558 end
'
' ....above is zircalloy casing around assembly
h2o 11 den=0.7627 1 552 end
'
' ....above is channel moderator at higher density
end comp
'
' -----
'
' fuel-pin-cell geometry:
'
squarepitch 1.875 1.242 1 3 1.430 2 end
'
' -----
'
' assembly and cycle parameters:
'
printlevel=4 lightel=8 inplevel=2 numzones=4 end
npin/assm=49 fuelngth=1731.1 ncycles=7 nlib/cyc=1
printlevel=4 lightel=8 inplevel=2 numzones=6 end
5 0.621 2 0.715 3 1.058
500 3.311 7 3.412 11 3.845

```

```

power=17.922 burn=268.67 down=0.0 end
power=17.922 burn=268.67 down=0.0 end
power=17.922 burn=268.67 down=60.0 end
power=17.796 burn=306.0 down=31.0 end
power=17.509 burn=165.0 down=800.0 end
power=10.753 burn=317.0 down=49.0 end
power= 8.535 burn=347.0 down=1954.0 end
      h  14.5      o  236      cr  2.1
      mn  0.13     fe  5.8      ni  2.1
      zr  455      sn  7.7
'
' -----
end

=sas2      parm='halt07,skipshipdata'
sas2 cooper bwr, assy cz346, rod add2966 cut-t, 33.94 gwd/mtu b5 7/97 4.3r
'
' -----
'
' mixtures of fuel-pin-unit-cell:
'
44group      latticecell
uo2  1 den=9.73      1  840  92234  0.026  92235  2.939  92236  0.014
                        92238  97.021      end
co-59  3 0 1-20 558 end
zr-94  1 0 1-20 840 end
nb-95  1 0 1-20 840 end
mo-95  1 0 1-20 840 end
tc-99  1 0 1-20 840 end
rh-103 1 0 1-20 840 end
rh-105 1 0 1-20 840 end
ru-106 1 0 1-20 840 end
sn-126 1 0 1-20 840 end
xe-131 1 0 1-20 840 end
cs-134 1 0 1-20 840 end
cs-135 1 0 1-20 840 end
cs-137 1 0 1-20 840 end
pr-143 1 0 1-20 840 end
nd-143 1 0 1-20 840 end
ce-144 1 0 1-20 840 end
nd-144 1 0 1-20 840 end
nd-145 1 0 1-20 840 end
nd-146 1 0 1-20 840 end
nd-147 1 0 1-20 840 end
pm-147 1 0 1-20 840 end
sm-147 1 0 1-20 840 end
nd-148 1 0 1-20 840 end
pm-148 1 0 1-20 840 end
sm-148 1 0 1-20 840 end
pm-149 1 0 1-20 840 end
sm-149 1 0 1-20 840 end
nd-150 1 0 1-20 840 end
sm-150 1 0 1-20 840 end
sm-151 1 0 1-20 840 end
eu-151 1 0 1-20 840 end
sm-152 1 0 1-20 840 end
eu-153 1 0 1-20 840 end
eu-154 1 0 1-20 840 end
eu-155 1 0 1-20 840 end
' need the following to use endf/b5 library:
zirc2  2 1 620 end
'

```

```

h2o 3 den=0.5736 1 558 end
'
' -----
'
' mixtures of larger-unit-cell:
'
uo2 5 den=9.73 1 840 92234 0.026 92235 2.939 92236 0.014
    92238 97.021 end
arbm-gdburn 9.73 7 0 1 1
    64154 2.18 64155 14.80 64156 20.47
    64157 15.65 64158 24.84 64160 21.86
    8016 150.0 5 0.034 840 end
'
' ....above is 3.4 wt % gadolinium (as gd2-ox3) in the
' burnable poison pins of bwr assembly....
'
' need the following to use endf/b5 library:
zirc2 7 1 558 end
'
' ....above is zircalloy casing around assembly
h2o 11 den=0.7627 1 552 end
'
' ....above is channel moderator at higher density
end comp
'
' -----
'
' fuel-pin-cell geometry:
'
squarepitch 1.875 1.242 1 3 1.430 2 end
'
' -----
'
' assembly and cycle parameters:
'
printlevel=4 lightel=8 inplevel=2 numzones=4 end
npin/assm=49 fuelngth=1731.1 ncycles=7 nlib/cyc=1
printlevel=4 lightel=8 inplevel=2 numzones=6 end
5 0.621 2 0.715 3 1.058
500 3.311 7 3.412 11 3.845
power=18.394 burn=268.67 down=0.0 end
power=18.394 burn=268.67 down=0.0 end
power=18.394 burn=268.67 down=60.0 end
power=18.264 burn=306.0 down=31.0 end
power=17.970 burn=165.0 down=800.0 end
power=11.036 burn=317.0 down=49.0 end
power=8.760 burn=347.0 down=1954.0 end
h 14.5 o 236 cr 2.1
mn 0.13 fe 5.8 ni 2.1
zr 455 sn 7.7
'
' -----
end

=sas2 parm='halt07,skipshipdata'
sas2 cooper bwr, assy cz346, rod add2974 cut-b, 17.84 gwd/mtu b5 7/97 4.3r
'
' -----
'
' mixtures of fuel-pin-unit-cell:
'
44group latticecell
uo2 1 den=9.73 1 840 92234 0.026 92235 2.939 92236 0.014
    92238 97.021 end
co-59 3 0 1-20 558 end

```

```

zr-94  1 0 1-20 840  end
nb-95  1 0 1-20 840  end
mo-95  1 0 1-20 840  end
tc-99  1 0 1-20 840  end
rh-103 1 0 1-20 840  end
rh-105 1 0 1-20 840  end
ru-106 1 0 1-20 840  end
sn-126 1 0 1-20 840  end
xe-131 1 0 1-20 840  end
cs-134 1 0 1-20 840  end
cs-135 1 0 1-20 840  end
cs-137 1 0 1-20 840  end
pr-143 1 0 1-20 840  end
nd-143 1 0 1-20 840  end
ce-144 1 0 1-20 840  end
nd-144 1 0 1-20 840  end
nd-145 1 0 1-20 840  end
nd-146 1 0 1-20 840  end
nd-147 1 0 1-20 840  end
pm-147 1 0 1-20 840  end
sm-147 1 0 1-20 840  end
nd-148 1 0 1-20 840  end
pm-148 1 0 1-20 840  end
sm-148 1 0 1-20 840  end
pm-149 1 0 1-20 840  end
sm-149 1 0 1-20 840  end
nd-150 1 0 1-20 840  end
sm-150 1 0 1-20 840  end
sm-151 1 0 1-20 840  end
eu-151 1 0 1-20 840  end
sm-152 1 0 1-20 840  end
eu-153 1 0 1-20 840  end
eu-154 1 0 1-20 840  end
eu-155 1 0 1-20 840  end
'   need the following to use endf/b5 library:
zirc2  2 1 620  end
'
h2o    3 den=0.3452   1  558 end
'
'   -----
'
'   mixtures of larger-unit-cell:
'
uo2    5 den=9.73     1  840  92234  0.026  92235  2.939   92236  0.014
          92238 97.021   end
arbm-gdburn  9.73     7 0 1 1
          64154  2.18  64155 14.80  64156 20.47
          64157 15.65  64158 24.84  64160 21.86
          8016 150.0  5   0.034  840  end
'
'   ....above is 3.4 wt % gadolinium (as gd2-ox3) in the
'   burnable poison pins of bwr assembly....
'
'   need the following to use endf/b5 library:
zirc2  7 1 558  end
'
'   ....above is zircalloy casing around assembly
h2o    11 den=0.7627   1  552  end
'
'   ....above is channel moderator at higher density
end comp
'
'   -----
'
'   fuel-pin-cell geometry:
'
squarepitch  1.875  1.242  1 3  1.430  2  end

```

```

'
' -----
'   assembly and cycle parameters:
'
'   printlevel=4 lightel=8 inplevel=2 numzones=4   end
npin/assm=49 fuelngth=1731.1 ncycles=7 nlib/cyc=1
printlevel=4 lightel=8 inplevel=2 numzones=6   end
5 0.621 2 0.715 3 1.058
500 3.311 7 3.412 11 3.845
power= 9.668 burn=268.67 down=0.0      end
power= 9.668 burn=268.67 down=0.0      end
power= 9.668 burn=268.67 down=60.0     end
power= 9.600 burn=306.0  down=31.0     end
power= 9.446 burn=165.0  down=800.0    end
power= 5.801 burn=317.0  down=49.0     end
power= 4.605 burn=347.0  down=1929.0   end
      h  14.5      o  236      cr  2.1
      mn  0.13     fe  5.8      ni  2.1
      zr  455      sn  7.7
'
' -----
end

=sas2      parm='halt07,skipshipdata'
sas2 cooper bwr, assy cz346, rod add2974 cut-j, 29.23 gwd/mtu b5 7/97 4.3r
'
' -----
'   mixtures of fuel-pin-unit-cell:
'
44group      latticecell
uo2 1 den=9.73 1 840 92234 0.026 92235 2.939 92236 0.014
      92238 97.021      end
co-59 3 0 1-20 558 end
zr-94 1 0 1-20 840 end
nb-95 1 0 1-20 840 end
mo-95 1 0 1-20 840 end
tc-99 1 0 1-20 840 end
rh-103 1 0 1-20 840 end
rh-105 1 0 1-20 840 end
ru-106 1 0 1-20 840 end
sn-126 1 0 1-20 840 end
xe-131 1 0 1-20 840 end
cs-134 1 0 1-20 840 end
cs-135 1 0 1-20 840 end
cs-137 1 0 1-20 840 end
pr-143 1 0 1-20 840 end
nd-143 1 0 1-20 840 end
ce-144 1 0 1-20 840 end
nd-144 1 0 1-20 840 end
nd-145 1 0 1-20 840 end
nd-146 1 0 1-20 840 end
nd-147 1 0 1-20 840 end
pm-147 1 0 1-20 840 end
sm-147 1 0 1-20 840 end
nd-148 1 0 1-20 840 end
pm-148 1 0 1-20 840 end
sm-148 1 0 1-20 840 end
pm-149 1 0 1-20 840 end
sm-149 1 0 1-20 840 end
nd-150 1 0 1-20 840 end

```



```

sm-150 1 0 1-20 840 end
sm-151 1 0 1-20 840 end
eu-151 1 0 1-20 840 end
sm-152 1 0 1-20 840 end
eu-153 1 0 1-20 840 end
eu-154 1 0 1-20 840 end
eu-155 1 0 1-20 840 end
' need the following to use endf/b5 library:
zirc2 2 1 620 end
'
h2o 3 den=0.3723 1 558 end
'
' -----
'
' mixtures of larger-unit-cell:
'
uo2 5 den=9.73 1 840 92234 0.026 92235 2.939 92236 0.014
92238 97.021 end
arbm-gdburn 9.73 7 0 1 1
64154 2.18 64155 14.80 64156 20.47
64157 15.65 64158 24.84 64160 21.86
8016 150.0 5 0.034 840 end
' ....above is 3.4 wt % gadolinium (as gd2-ox3) in the
' burnable poison pins of bwr assembly....
'
' need the following to use endf/b5 library:
zirc2 7 1 558 end
' ....above is zircalloy casing around assembly
h2o 11 den=0.7627 1 552 end
' ....above is channel moderator at higher density
end comp
'
' -----
'
' fuel-pin-cell geometry:
'
squarepitch 1.875 1.242 1 3 1.430 2 end
'
' -----
'
' assembly and cycle parameters:
'
printlevel=4 lightel=8 inplevel=2 numzones=4 end
npin/assm=49 fuelngth=1731.1 ncycles=7 nlib/cyc=1
printlevel=4 lightel=8 inplevel=2 numzones=6 end
5 0.621 2 0.715 3 1.058
500 3.311 7 3.412 11 3.845
power=15.841 burn=268.67 down=0.0 end
power=15.841 burn=268.67 down=0.0 end
power=15.841 burn=268.67 down=60.0 end
power=15.729 burn=306.0 down=31.0 end
power=15.476 burn=165.0 down=800.0 end
power= 9.504 burn=317.0 down=49.0 end
power= 7.544 burn=347.0 down=1929.0 end
h 14.5 o 236 cr 2.1
mn 0.13 fe 5.8 ni 2.1
zr 455 sn 7.7
'
' -----
end

=sas2 parm='halt07,skipshipdata'

```

sas2 cooper bwr, assy cz346, rod add2974 cut-u, 31.04 gwd/mtu b5 7/97 4.3r

```
'
' -----
'
'   mixtures of fuel-pin-unit-cell:
'
44group          latticecell
uo2  1 den=9.73    1  840  92234  0.026  92235  2.939   92236  0.014
      92238 97.021    end
co-59  3 0 1-20 558  end
zr-94  1 0 1-20 840  end
nb-95  1 0 1-20 840  end
mo-95  1 0 1-20 840  end
tc-99  1 0 1-20 840  end
rh-103 1 0 1-20 840  end
rh-105 1 0 1-20 840  end
ru-106 1 0 1-20 840  end
sn-126 1 0 1-20 840  end
xe-131 1 0 1-20 840  end
cs-134 1 0 1-20 840  end
cs-135 1 0 1-20 840  end
cs-137 1 0 1-20 840  end
pr-143 1 0 1-20 840  end
nd-143 1 0 1-20 840  end
ce-144 1 0 1-20 840  end
nd-144 1 0 1-20 840  end
nd-145 1 0 1-20 840  end
nd-146 1 0 1-20 840  end
nd-147 1 0 1-20 840  end
pm-147 1 0 1-20 840  end
sm-147 1 0 1-20 840  end
nd-148 1 0 1-20 840  end
pm-148 1 0 1-20 840  end
sm-148 1 0 1-20 840  end
pm-149 1 0 1-20 840  end
sm-149 1 0 1-20 840  end
nd-150 1 0 1-20 840  end
sm-150 1 0 1-20 840  end
sm-151 1 0 1-20 840  end
eu-151 1 0 1-20 840  end
sm-152 1 0 1-20 840  end
eu-153 1 0 1-20 840  end
eu-154 1 0 1-20 840  end
eu-155 1 0 1-20 840  end
'   need the following to use endf/b5 library:
zirc2  2 1 620  end
'
h2o   3 den=0.6124    1  558  end
'
' -----
'
'   mixtures of larger-unit-cell:
'
uo2  5 den=9.73    1  840  92234  0.026  92235  2.939   92236  0.014
      92238 97.021    end
arbm-gdburn  9.73    7 0 1 1
      64154  2.18  64155 14.80  64156 20.47
      64157 15.65  64158 24.84  64160 21.86
      8016 150.0  5  0.034  840  end
'   ....above is 3.4 wt % gadolinium (as gd2-ox3) in the
'   burnable poison pins of bwr assembly....
'
'   need the following to use endf/b5 library:
zirc2  7 1 558  end
```

```

'          ....above is zircalloy casing around assembly
h2o      11  den=0.7627  1  552  end
'          ....above is channel moderator at higher density
end comp
'
'-----
'          fuel-pin-cell geometry:
'
squarepitch  1.875  1.242  1 3  1.430  2  end
'
'-----
'          assembly and cycle parameters:
'
printlevel=4  lightel=8  inplevel=2  numzones=4  end
npin/assm=49  fuelngth=1731.1  ncycles=7  nlib/cyc=1
printlevel=4  lightel=8  inplevel=2  numzones=6  end
5  0.621  2  0.715  3  1.058
500 3.311  7 3.412  11 3.845
power=16.822 burn=268.67  down=0.0  end
power=16.822 burn=268.67  down=0.0  end
power=16.822 burn=268.67  down=60.0  end
power=16.703 burn=306.0  down=31.0  end
power=16.435 burn=165.0  down=800.0  end
power=10.093 burn=317.0  down=49.0  end
power= 8.011 burn=347.0  down=1929.0  end
      h  14.5  o  236  cr  2.1
      mn  0.13  fe  5.8  ni  2.1
      zr  455  sn  7.7
'
'-----
end

```

APPENDIX C
INPUT LISTINGS FOR GUNDREMMINGEN BWR
SAS2H DEPLETION CALCULATIONS

```
=sas2      parm='halt04,skipshipdata'
gundremmingen bwr, assy b23, rod a1, 44 cm, 25.730 gwd/mtu b5 7/97 4.3r
'
'-----
'
' mixtures of fuel-pin-unit-cell:
'
44group      latticecell
uo2  1 den=10.068 1 923 92234 0.023 92235 2.53 92236 0.012
      92238 97.435 end
co-59  3 0 1-20 549 end
zr-94  1 0 1-20 923 end
nb-95  1 0 1-20 923 end
mo-95  1 0 1-20 923 end
tc-99  1 0 1-20 923 end
rh-103 1 0 1-20 923 end
rh-105 1 0 1-20 923 end
ru-106 1 0 1-20 923 end
sn-126 1 0 1-20 923 end
xe-131 1 0 1-20 923 end
cs-134 1 0 1-20 923 end
cs-135 1 0 1-20 923 end
cs-137 1 0 1-20 923 end
pr-143 1 0 1-20 923 end
nd-143 1 0 1-20 923 end
ce-144 1 0 1-20 923 end
nd-144 1 0 1-20 923 end
nd-145 1 0 1-20 923 end
nd-146 1 0 1-20 923 end
nd-147 1 0 1-20 923 end
pm-147 1 0 1-20 923 end
sm-147 1 0 1-20 923 end
nd-148 1 0 1-20 923 end
pm-148 1 0 1-20 923 end
sm-148 1 0 1-20 923 end
pm-149 1 0 1-20 923 end
sm-149 1 0 1-20 923 end
nd-150 1 0 1-20 923 end
sm-150 1 0 1-20 923 end
sm-151 1 0 1-20 923 end
eu-151 1 0 1-20 923 end
sm-152 1 0 1-20 923 end
eu-153 1 0 1-20 923 end
eu-154 1 0 1-20 923 end
gd-154 1 0 1-20 923 end
eu-155 1 0 1-20 923 end
gd-155 1 0 1-20 923 end
gd-157 1 0 1-20 923 end
gd-158 1 0 1-20 923 end
gd-160 1 0 1-20 923 end
' need the following to use endf/b5 library:
zirc2  2 1 620 end
'
h2o  3 den=0.7378 1 549 end
'
```

```

' -----
'
' mixtures of larger-unit-cell:
'
' need the following to use endf/b5 library:
zirc2  7 1 549 end
'
'      ....above is zircalloy casing around assembly
h2o    8 den=0.7750 1 539 end
b-10   8 0 4.0-5 539 end
h2o    12 den=0.7750 1 539 end
b-10   12 0 6.0-6 539 end
'
'      ....above is channel moderator at higher density
uo2  9 den=10.068 1 923 92234 0.023 92235 2.53 92236 0.012
      92238 97.435 end
end comp
'

```

```

' -----
'
' fuel-pin-cell geometry:
squarepitch 1.780 1.250 1 3 1.428 2 end
'

```

```

' -----
'
' assembly and cycle parameters:
npin/assm=36 fuelngth=2550.5 ncycles=4 nlib/cyc=1
printlevel=4 lightel=8 inplevel=2 numzones=7
mxrepeats=0 end
9 0.625 2 0.714 3 1.0043
500 6.026 3 6.235 7 6.405 8 7.390
9 0.625 2 0.714 3 1.0043
500 6.026 3 6.235 7 6.405 12 7.390
9 0.625 2 0.714 3 1.0043
500 6.026 3 6.235 7 6.405 12 7.390
9 0.625 2 0.714 3 1.0043
500 6.026 3 6.235 7 6.405 12 7.390
power=23.798 burn=279 down=56 end
power=21.584 burn=323 down=33 end
power=21.500 burn=290 down=61 end
power=19.041 burn=309 down=1047 end
h 16.4 o 265.0 cr 2.4
mn 0.15 fe 6.6 ni 2.4
zr 516.0 sn 8.7
'

```

```

end

```

```

=sas2 parm='halt04,skipshipdata'
gundremmingen bwr, assy b23, rod a1, 268 cm, 27.400 gwd/mtu b5 7/97 4.3r
'

```

```

' -----
'
' mixtures of fuel-pin-unit-cell:
'
44group latticecell
uo2 1 den=10.068 1 923 92234 0.023 92235 2.53 92236 0.012
      92238 97.435 end
co-59 3 0 1-20 549 end
'

```

```

zr-94  1 0 1-20 923  end
nb-95  1 0 1-20 923  end
mo-95  1 0 1-20 923  end
tc-99  1 0 1-20 923  end
rh-103 1 0 1-20 923  end
rh-105 1 0 1-20 923  end
ru-106 1 0 1-20 923  end
sn-126 1 0 1-20 923  end
xe-131 1 0 1-20 923  end
cs-134 1 0 1-20 923  end
cs-135 1 0 1-20 923  end
cs-137 1 0 1-20 923  end
pr-143 1 0 1-20 923  end
nd-143 1 0 1-20 923  end
ce-144 1 0 1-20 923  end
nd-144 1 0 1-20 923  end
nd-145 1 0 1-20 923  end
nd-146 1 0 1-20 923  end
nd-147 1 0 1-20 923  end
pm-147 1 0 1-20 923  end
sm-147 1 0 1-20 923  end
nd-148 1 0 1-20 923  end
pm-148 1 0 1-20 923  end
sm-148 1 0 1-20 923  end
pm-149 1 0 1-20 923  end
sm-149 1 0 1-20 923  end
nd-150 1 0 1-20 923  end
sm-150 1 0 1-20 923  end
sm-151 1 0 1-20 923  end
eu-151 1 0 1-20 923  end
sm-152 1 0 1-20 923  end
eu-153 1 0 1-20 923  end
eu-154 1 0 1-20 923  end
gd-154 1 0 1-20 923  end
eu-155 1 0 1-20 923  end
gd-155 1 0 1-20 923  end
gd-157 1 0 1-20 923  end
gd-158 1 0 1-20 923  end
gd-160 1 0 1-20 923  end
'   need the following to use endf/b5 library:
zirc2  2 1  620  end
'
h2o  3 den=0.3145  1  549 end
'
' -----
'
'   mixtures of larger-unit-cell:
'
'   need the following to use endf/b5 library:
zirc2  7 1  549  end
'
'   ....above is zircalloy casing around assembly
h2o      8  den=0.7750  1  539 end
b-10     8  0  4.0-5  539 end
h2o     12  den=0.7750  1  539 end
b-10     12  0  6.0-6  539 end
'
'   ....above is channel moderator at higher density
uo2  9 den=10.068 1  923 92234 0.023 92235 2.53 92236 0.012
      92238 97.435  end
end comp
'
' -----
'
'   fuel-pin-cell geometry:

```

```

squarepitch  1.780  1.250  1 3  1.428  2  end
-----
assembly and cycle parameters:
npin/assm=36  fuelngth=2550.5  ncycles=4  nlib/cyc=1
printlevel=4  lightel=8  inplevel=2  numzones=7
mxrepeats=0  end
9  0.625  2  0.714  3  1.0043
  500 6.026  3  6.235  7  6.405  8  7.390
9  0.625  2  0.714  3  1.0043
  500 6.026  3  6.235  7  6.405  12  7.390
9  0.625  2  0.714  3  1.0043
  500 6.026  3  6.235  7  6.405  12  7.390
9  0.625  2  0.714  3  1.0043
  500 6.026  3  6.235  7  6.405  12  7.390
power=25.343  burn=279  down=56  end
power=22.985  burn=323  down=33  end
power=22.895  burn=290  down=61  end
power=20.276  burn=309  down=1053  end
  h  16.4  o  265.0  cr  2.4
  mn  0.15  fe  6.6  ni  2.4
  zr  516.0  sn  8.7
-----
end

=sas2  parm='halt04,skipshipdata'
gundremmingen bwr, assy b23, rod b3, 268 cm, 21.240 gwd/mtu b5 7/97 4.3r
-----
mixtures of fuel-pin-unit-cell:
44group  latticecell
uo2  1 den=10.068  1  923  92234  0.023  92235  2.53  92236  0.012
      92238  97.435  end
co-59  3 0 1-20 549  end
zr-94  1 0 1-20 923  end
nb-95  1 0 1-20 923  end
mo-95  1 0 1-20 923  end
tc-99  1 0 1-20 923  end
rh-103 1 0 1-20 923  end
rh-105 1 0 1-20 923  end
ru-106 1 0 1-20 923  end
sn-126 1 0 1-20 923  end
xe-131 1 0 1-20 923  end
cs-134 1 0 1-20 923  end
cs-135 1 0 1-20 923  end
cs-137 1 0 1-20 923  end
pr-143 1 0 1-20 923  end
nd-143 1 0 1-20 923  end
ce-144 1 0 1-20 923  end
nd-144 1 0 1-20 923  end
nd-145 1 0 1-20 923  end
nd-146 1 0 1-20 923  end
nd-147 1 0 1-20 923  end
pm-147 1 0 1-20 923  end

```

```

sm-147 1 0 1-20 923 end
nd-148 1 0 1-20 923 end
pm-148 1 0 1-20 923 end
sm-148 1 0 1-20 923 end
pm-149 1 0 1-20 923 end
sm-149 1 0 1-20 923 end
nd-150 1 0 1-20 923 end
sm-150 1 0 1-20 923 end
sm-151 1 0 1-20 923 end
eu-151 1 0 1-20 923 end
sm-152 1 0 1-20 923 end
eu-153 1 0 1-20 923 end
eu-154 1 0 1-20 923 end
gd-154 1 0 1-20 923 end
eu-155 1 0 1-20 923 end
gd-155 1 0 1-20 923 end
gd-157 1 0 1-20 923 end
gd-158 1 0 1-20 923 end
gd-160 1 0 1-20 923 end
' need the following to use endf/b5 library:
zirc2 2 1 620 end
'
h2o 3 den=0.3145 1 549 end
'
' -----
'
' mixtures of larger-unit-cell:
'
' need the following to use endf/b5 library:
zirc2 7 1 549 end
'
' ....above is zircalloy casing around assembly
h2o 8 den=0.7750 1 539 end
b-10 8 0 4.0-5 539 end
h2o 12 den=0.7750 1 539 end
b-10 12 0 6.0-6 539 end
'
' ....above is channel moderator at higher density
uo2 9 den=10.068 1 923 92234 0.023 92235 2.53 92236 0.012
92238 97.435 end
end comp
'
' -----
'
' fuel-pin-cell geometry:
'
squarepitch 1.780 1.250 1 3 1.428 2 end
'
' -----
'
' assembly and cycle parameters:
'
npin/assm=36 fuelngth=2550.5 ncycles=4 nlib/cyc=1
printlevel=4 lightel=8 inplevel=2 numzones=7
mxrepeats=0 end
9 0.625 2 0.714 3 1.0043
500 6.026 3 6.235 7 6.405 8 7.390
9 0.625 2 0.714 3 1.0043
500 6.026 3 6.235 7 6.405 12 7.390
9 0.625 2 0.714 3 1.0043
500 6.026 3 6.235 7 6.405 12 7.390
9 0.625 2 0.714 3 1.0043
500 6.026 3 6.235 7 6.405 12 7.390
power=19.645 burn=279 down=56 end
power=17.818 burn=323 down=33 end

```



```

power=17.748 burn=290 down=61 end
power=15.718 burn=309 down=1010 end
  h 16.4 o 265.0 cr 2.4
  mn 0.15 fe 6.6 ni 2.4
  zr 516.0 sn 8.7

```

```

' -----
end

```

```

=sas2      parm='halt04,skipshipdata'
gundremmingen bwr, assy b23, rod e3, 268 cm, 23.510 gwd/mtu b5 7/97 4.3r

```

```

' -----

```

```

' mixtures of fuel-pin-unit-cell:

```

```

44group      latticecell
uo2 1 den=10.068 1 923 92234 0.023 92235 2.53 92236 0.012
          92238 97.435 end
co-59 3 0 1-20 549 end
zr-94 1 0 1-20 923 end
nb-95 1 0 1-20 923 end
mo-95 1 0 1-20 923 end
tc-99 1 0 1-20 923 end
rh-103 1 0 1-20 923 end
rh-105 1 0 1-20 923 end
ru-106 1 0 1-20 923 end
sn-126 1 0 1-20 923 end
xe-131 1 0 1-20 923 end
cs-134 1 0 1-20 923 end
cs-135 1 0 1-20 923 end
cs-137 1 0 1-20 923 end
pr-143 1 0 1-20 923 end
nd-143 1 0 1-20 923 end
ce-144 1 0 1-20 923 end
nd-144 1 0 1-20 923 end
nd-145 1 0 1-20 923 end
nd-146 1 0 1-20 923 end
nd-147 1 0 1-20 923 end
pm-147 1 0 1-20 923 end
sm-147 1 0 1-20 923 end
nd-148 1 0 1-20 923 end
pm-148 1 0 1-20 923 end
sm-148 1 0 1-20 923 end
pm-149 1 0 1-20 923 end
sm-149 1 0 1-20 923 end
nd-150 1 0 1-20 923 end
sm-150 1 0 1-20 923 end
sm-151 1 0 1-20 923 end
eu-151 1 0 1-20 923 end
sm-152 1 0 1-20 923 end
eu-153 1 0 1-20 923 end
eu-154 1 0 1-20 923 end
gd-154 1 0 1-20 923 end
eu-155 1 0 1-20 923 end
gd-155 1 0 1-20 923 end
gd-157 1 0 1-20 923 end
gd-158 1 0 1-20 923 end
gd-160 1 0 1-20 923 end

```

```

' need the following to use endf/b5 library:

```

```

zirc2  2 1  620  end
|
h2o  3 den=0.3145  1  549 end
|
|-----|
|
|  mixtures of larger-unit-cell:
|
|  need the following to use endf/b5 library:
zirc2  7 1  549  end
|
|      ....above is zircalloy casing around assembly
h2o      8  den=0.7750  1  539 end
b-10     8  0  4.0-5  539 end
h2o     12  den=0.7750  1  539 end
b-10    12  0  6.0-6  539 end
|
|      ....above is channel moderator at higher density
uo2  9 den=10.068 1  923 92234 0.023 92235 2.53 92236 0.012
|      92238 97.435  end
end comp
|
|-----|
|
|      fuel-pin-cell geometry:
|
squarepitch  1.780  1.250  1 3  1.428  2  end
|
|-----|
|
|      assembly and cycle parameters:
|
npin/assm=36 fuelngth=2550.5 ncycles=4 nlib/cyc=1
printlevel=4 lightel=8 inplevel=2 numzones=7
mxrepeats=0  end
9 0.625  2 0.714  3 1.0043
 500 6.026  3 6.235  7 6.405  8 7.390
9 0.625  2 0.714  3 1.0043
 500 6.026  3 6.235  7 6.405  12 7.390
9 0.625  2 0.714  3 1.0043
 500 6.026  3 6.235  7 6.405  12 7.390
9 0.625  2 0.714  3 1.0043
 500 6.026  3 6.235  7 6.405  12 7.390
power=21.745  burn=279  down=56  end
power=19.722  burn=323  down=33  end
power=19.645  burn=290  down=61  end
power=17.398  burn=309  down=1244  end
      h  16.4  o  265.0  cr  2.4
      mn  0.15  fe  6.6  ni  2.4
      zr  516.0  sn  8.7
|
|-----|
end

=sas2  parm='halt03,skipshipdata'
gundremmingen bwr, assy cl6, rod a1, 44 cm, 20.300 gwd/mtu b5 7/97 4.3r
|
|-----|
|
|  mixtures of fuel-pin-unit-cell:
|

```

```

44group      latticecell
uo2  1 den=9.866 1 923 92234 0.023 92235 2.53 92236 0.012
      92238 97.435 end
co-59  3 0 1-20 549 end
zr-94  1 0 1-20 923 end
nb-95  1 0 1-20 923 end
mo-95  1 0 1-20 923 end
tc-99  1 0 1-20 923 end
rh-103 1 0 1-20 923 end
rh-105 1 0 1-20 923 end
ru-106 1 0 1-20 923 end
sn-126 1 0 1-20 923 end
xe-131 1 0 1-20 923 end
cs-134 1 0 1-20 923 end
cs-135 1 0 1-20 923 end
cs-137 1 0 1-20 923 end
pr-143 1 0 1-20 923 end
nd-143 1 0 1-20 923 end
ce-144 1 0 1-20 923 end
nd-144 1 0 1-20 923 end
nd-145 1 0 1-20 923 end
nd-146 1 0 1-20 923 end
nd-147 1 0 1-20 923 end
pm-147 1 0 1-20 923 end
sm-147 1 0 1-20 923 end
nd-148 1 0 1-20 923 end
pm-148 1 0 1-20 923 end
sm-148 1 0 1-20 923 end
pm-149 1 0 1-20 923 end
sm-149 1 0 1-20 923 end
nd-150 1 0 1-20 923 end
sm-150 1 0 1-20 923 end
sm-151 1 0 1-20 923 end
eu-151 1 0 1-20 923 end
sm-152 1 0 1-20 923 end
eu-153 1 0 1-20 923 end
eu-154 1 0 1-20 923 end
gd-154 1 0 1-20 923 end
eu-155 1 0 1-20 923 end
gd-155 1 0 1-20 923 end
gd-157 1 0 1-20 923 end
gd-158 1 0 1-20 923 end
gd-160 1 0 1-20 923 end
' need the following to use endf/b5 library:
zirc2  2 1 620 end
'
h2o  3 den=0.7460 1 549 end
'
' -----
'
' mixtures of larger-unit-cell:
'
' need the following to use endf/b5 library:
zirc2  7 1 549 end
'
' ....above is zircalloy casing around assembly
h2o  8 den=0.7750 1 539 end
b-10 8 0 4.0-5 539 end
h2o  12 den=0.7750 1 539 end
b-10 12 0 6.0-6 539 end
'
' ....above is channel moderator at higher density
uo2  9 den=9.866 1 923 92234 0.023 92235 2.53 92236 0.012
      92238 97.435 end
end comp

```

```

'
' -----
'
'      fuel-pin-cell geometry:
'
squarepitch  1.780  1.250  1 3  1.428  2  end
'
' -----
'
'      assembly and cycle parameters:
'
npin/assm=36  fuelngth=2601.4  ncycles=3  nlib/cyc=1
printlevel=4  lightel=8  inplevel=2  numzones=7
mxrepeats=0  end
9  0.625  2  0.714  3  1.0043
  500 6.026  3 6.235  7 6.405  8 7.390
9  0.625  2  0.714  3  1.0043
  500 6.026  3 6.235  7 6.405  12 7.390
9  0.625  2  0.714  3  1.0043
  500 6.026  3 6.235  7 6.405  12 7.390
power=21.942  burn=323  down=33  end
power=20.847  burn=290  down=61  end
power=23.194  burn=309  down=1242  end
      h  16.4      o  265.0      cr  2.4
      mn  0.15     fe  6.6       ni  2.4
      zr  516.0    sn  8.7
'
' -----
end

```

```

=sas2      parm='halt03,skipshipdata'
gundremmingen bwr, assy c16, rod a1, 268 cm, 19.850 gwd/mtu b5 7/97 4.3r
'
' -----
'

```

```

'      mixtures of fuel-pin-unit-cell:
'
44group      latticecell
uo2  1 den=9.866  1  923  92234  0.023  92235  2.53  92236  0.012
      92238  97.435  end
co-59  3 0 1-20 549  end
zr-94  1 0 1-20 923  end
nb-95  1 0 1-20 923  end
mo-95  1 0 1-20 923  end
tc-99  1 0 1-20 923  end
rh-103 1 0 1-20 923  end
rh-105 1 0 1-20 923  end
ru-106 1 0 1-20 923  end
sn-126 1 0 1-20 923  end
xe-131 1 0 1-20 923  end
cs-134 1 0 1-20 923  end
cs-135 1 0 1-20 923  end
cs-137 1 0 1-20 923  end
pr-143 1 0 1-20 923  end
nd-143 1 0 1-20 923  end
ce-144 1 0 1-20 923  end
nd-144 1 0 1-20 923  end
nd-145 1 0 1-20 923  end
nd-146 1 0 1-20 923  end
nd-147 1 0 1-20 923  end

```

```

pm-147 1 0 1-20 923 end
sm-147 1 0 1-20 923 end
nd-148 1 0 1-20 923 end
pm-148 1 0 1-20 923 end
sm-148 1 0 1-20 923 end
pm-149 1 0 1-20 923 end
sm-149 1 0 1-20 923 end
nd-150 1 0 1-20 923 end
sm-150 1 0 1-20 923 end
sm-151 1 0 1-20 923 end
eu-151 1 0 1-20 923 end
sm-152 1 0 1-20 923 end
eu-153 1 0 1-20 923 end
eu-154 1 0 1-20 923 end
gd-154 1 0 1-20 923 end
eu-155 1 0 1-20 923 end
gd-155 1 0 1-20 923 end
gd-157 1 0 1-20 923 end
gd-158 1 0 1-20 923 end
gd-160 1 0 1-20 923 end
' need the following to use endf/b5 library:
zirc2 2 1 620 end
'
h2o 3 den=0.3849 1 549 end
'
' -----
'
' mixtures of larger-unit-cell:
'
' need the following to use endf/b5 library:
zirc2 7 1 549 end
'
' ....above is zircalloy casing around assembly
h2o 8 den=0.7750 1 539 end
b-10 8 0 4.0-5 539 end
h2o 12 den=0.7750 1 539 end
b-10 12 0 6.0-6 539 end
'
' ....above is channel moderator at higher density
uo2 9 den=9.866 1 923 92234 0.023 92235 2.53 92236 0.012
92238 97.435 end
end comp
'
' -----
'
' fuel-pin-cell geometry:
squarepitch 1.780 1.250 1 3 1.428 2 end
'
' -----
'
' assembly and cycle parameters:
'
npin/assm=36 fuelngth=2601.4 ncycles=3 nlib/cyc=1
printlevel=4 lightel=8 inplevel=2 numzones=7
mxrepeats=0 end
9 0.625 2 0.714 3 1.0043
500 6.026 3 6.235 7 6.405 8 7.390
9 0.625 2 0.714 3 1.0043
500 6.026 3 6.235 7 6.405 12 7.390
9 0.625 2 0.714 3 1.0043
500 6.026 3 6.235 7 6.405 12 7.390
power=21.456 burn=323 down=33 end
power=20.384 burn=290 down=61 end
power=22.680 burn=309 down=1244 end

```

```

      h  16.4      o  265.0      cr  2.4
      mn 0.15     fe  6.6       ni  2.4
      zr 516.0    sn  8.7
'
' -----
end

=sas2      parm='halt03,skipshipdata'
gundremmingen bwr, assy c16, rod b3, 268 cm, 14.390 gwd/mtu b5 7/97 4.3r
'
' -----
'
'   mixtures of fuel-pin-unit-cell:
'
44group      latticecell
uo2  1 den=9.866 1 923 92234 0.023 92235 2.53 92236 0.012
      92238 97.435 end
co-59  3 0 1-20 549 end
zr-94  1 0 1-20 923 end
nb-95  1 0 1-20 923 end
mo-95  1 0 1-20 923 end
tc-99  1 0 1-20 923 end
rh-103 1 0 1-20 923 end
rh-105 1 0 1-20 923 end
ru-106 1 0 1-20 923 end
sn-126 1 0 1-20 923 end
xe-131 1 0 1-20 923 end
cs-134 1 0 1-20 923 end
cs-135 1 0 1-20 923 end
cs-137 1 0 1-20 923 end
pr-143 1 0 1-20 923 end
nd-143 1 0 1-20 923 end
ce-144 1 0 1-20 923 end
nd-144 1 0 1-20 923 end
nd-145 1 0 1-20 923 end
nd-146 1 0 1-20 923 end
nd-147 1 0 1-20 923 end
pm-147 1 0 1-20 923 end
sm-147 1 0 1-20 923 end
nd-148 1 0 1-20 923 end
pm-148 1 0 1-20 923 end
sm-148 1 0 1-20 923 end
pm-149 1 0 1-20 923 end
sm-149 1 0 1-20 923 end
nd-150 1 0 1-20 923 end
sm-150 1 0 1-20 923 end
sm-151 1 0 1-20 923 end
eu-151 1 0 1-20 923 end
sm-152 1 0 1-20 923 end
eu-153 1 0 1-20 923 end
eu-154 1 0 1-20 923 end
gd-154 1 0 1-20 923 end
eu-155 1 0 1-20 923 end
gd-155 1 0 1-20 923 end
gd-157 1 0 1-20 923 end
gd-158 1 0 1-20 923 end
gd-160 1 0 1-20 923 end
'   need the following to use endf/b5 library:
zirc2  2 1 620 end
'

```

```

h2o 3 den=0.3849 1 549 end
'
' -----
'
' mixtures of larger-unit-cell:
'
' need the following to use endf/b5 library:
zirc2 7 1 549 end
'
' ....above is zircalloy casing around assembly
h2o 8 den=0.7750 1 539 end
b-10 8 0 4.0-5 539 end
h2o 12 den=0.7750 1 539 end
b-10 12 0 6.0-6 539 end
'
' ....above is channel moderator at higher density
uo2 9 den=9.866 1 923 92234 0.023 92235 2.53 92236 0.012
92238 97.435 end
end comp
'
' -----
'
' fuel-pin-cell geometry:
'
squarepitch 1.780 1.250 1 3 1.428 2 end
'
' -----
'
' assembly and cycle parameters:
'
npin/assm=36 fuelngth=2601.4 ncycles=3 nlib/cyc=1
printlevel=4 lightel=8 inplevel=2 numzones=7
mxrepeats=0 end
9 0.625 2 0.714 3 1.0043
500 6.026 3 6.235 7 6.405 8 7.390
9 0.625 2 0.714 3 1.0043
500 6.026 3 6.235 7 6.405 12 7.390
9 0.625 2 0.714 3 1.0043
500 6.026 3 6.235 7 6.405 12 7.390
power=15.554 burn=323 down=33 end
power=14.777 burn=290 down=61 end
power=16.442 burn=309 down=1060.5 end
h 16.4 o 265.0 cr 2.4
mn 0.15 fe 6.6 ni 2.4
zr 516.0 sn 8.7
'
' -----
end

=sas2 parm='halt03,skipshipdata'
gundremmingen bwr, assy cl6, rod e5, 268 cm, 17.490 gwd/mtu b5 7/97 4.3r
'
' -----
'
' mixtures of fuel-pin-unit-cell:
'
44group latticecell
uo2 1 den=9.866 1 923 92234 0.023 92235 2.53 92236 0.012
92238 97.435 end
co-59 3 0 1-20 549 end
zr-94 1 0 1-20 923 end
nb-95 1 0 1-20 923 end
mo-95 1 0 1-20 923 end

```

```

tc-99  1 0 1-20 923  end
rh-103 1 0 1-20 923  end
rh-105 1 0 1-20 923  end
ru-106 1 0 1-20 923  end
sn-126 1 0 1-20 923  end
xe-131 1 0 1-20 923  end
cs-134 1 0 1-20 923  end
cs-135 1 0 1-20 923  end
cs-137 1 0 1-20 923  end
pr-143 1 0 1-20 923  end
nd-143 1 0 1-20 923  end
ce-144 1 0 1-20 923  end
nd-144 1 0 1-20 923  end
nd-145 1 0 1-20 923  end
nd-146 1 0 1-20 923  end
nd-147 1 0 1-20 923  end
pm-147 1 0 1-20 923  end
sm-147 1 0 1-20 923  end
nd-148 1 0 1-20 923  end
pm-148 1 0 1-20 923  end
sm-148 1 0 1-20 923  end
pm-149 1 0 1-20 923  end
sm-149 1 0 1-20 923  end
nd-150 1 0 1-20 923  end
sm-150 1 0 1-20 923  end
sm-151 1 0 1-20 923  end
eu-151 1 0 1-20 923  end
sm-152 1 0 1-20 923  end
eu-153 1 0 1-20 923  end
eu-154 1 0 1-20 923  end
gd-154 1 0 1-20 923  end
eu-155 1 0 1-20 923  end
gd-155 1 0 1-20 923  end
gd-157 1 0 1-20 923  end
gd-158 1 0 1-20 923  end
gd-160 1 0 1-20 923  end
'   need the following to use endf/b5 library:
zirc2  2 1  620  end
'
h2o  3 den=0.3849  1  549 end
'
'-----'
'   mixtures of larger-unit-cell:
'
'   need the following to use endf/b5 library:
zirc2  7 1  549  end
'   ....above is zircalloy casing around assembly
h2o      8  den=0.7750  1  539 end
b-10     8  0  4.0-5  539  end
h2o     12  den=0.7750  1  539 end
b-10    12  0  6.0-6  539  end
'   ....above is channel moderator at higher density
uo2  9 den=9.866 1  923  92234  0.023  92235  2.53  92236  0.012
          92238  97.435  end
end comp
'
'-----'
'   fuel-pin-cell geometry:
squarepitch  1.780  1.250  1 3  1.428  2  end
'

```



```
' -----  
'  
'   assembly and cycle parameters:  
'  
npin/assm=36  fuelngth=2601.4  ncycles=3  nlib/cyc=1  
printlevel=4  lightel=8  inplevel=2  numzones=7  
mxrepeats=0  end  
9 0.625 2 0.714 3 1.0043  
 500 6.026 3 6.235 7 6.405 8 7.390  
9 0.625 2 0.714 3 1.0043  
 500 6.026 3 6.235 7 6.405 12 7.390  
9 0.625 2 0.714 3 1.0043  
 500 6.026 3 6.235 7 6.405 12 7.390  
power=18.905  burn=323  down=33  end  
power=17.961  burn=290  down=61  end  
power=19.984  burn=309  down=1004  end  
  h 16.4  o 265.0  cr 2.4  
  mn 0.15  fe 6.6  ni 2.4  
  zr 516.0  sn 8.7  
'  
' -----  
end
```

APPENDIX D

INPUT LISTINGS FOR JPDR BWR SAS2H DEPLETION CALCULATIONS

```
=sas2      parm='halt04,skipshipdata'  
jpdr bwr, assy a-14, rod c-d-3-4, node #2, 3.3032 gwd/mtu b5 7/97 4.3r  
'  
-----  
'  
' mixtures of fuel-pin-unit-cell:  
'  
44group      latticecell  
uo2 1 den=10.13 1 840 92234 0.0153 92235 2.5966 92236 0.0161  
          92238 97.372 end  
co-59 3 0 1-20 550 end  
zr-94 1 0 1-20 840 end  
nb-95 1 0 1-20 840 end  
mo-95 1 0 1-20 840 end  
tc-99 1 0 1-20 840 end  
rh-103 1 0 1-20 840 end  
rh-105 1 0 1-20 840 end  
ru-106 1 0 1-20 840 end  
sn-126 1 0 1-20 840 end  
xe-131 1 0 1-20 840 end  
cs-134 1 0 1-20 840 end  
cs-135 1 0 1-20 840 end  
cs-137 1 0 1-20 840 end  
pr-143 1 0 1-20 840 end  
nd-143 1 0 1-20 840 end  
ce-144 1 0 1-20 840 end  
nd-144 1 0 1-20 840 end  
nd-145 1 0 1-20 840 end  
nd-146 1 0 1-20 840 end  
nd-147 1 0 1-20 840 end  
pm-147 1 0 1-20 840 end  
sm-147 1 0 1-20 840 end  
nd-148 1 0 1-20 840 end  
pm-148 1 0 1-20 840 end  
sm-148 1 0 1-20 840 end  
pm-149 1 0 1-20 840 end  
sm-149 1 0 1-20 840 end  
nd-150 1 0 1-20 840 end  
sm-150 1 0 1-20 840 end  
sm-151 1 0 1-20 840 end  
eu-151 1 0 1-20 840 end  
sm-152 1 0 1-20 840 end  
eu-153 1 0 1-20 840 end  
eu-154 1 0 1-20 840 end  
gd-154 1 0 1-20 840 end  
eu-155 1 0 1-20 840 end  
gd-155 1 0 1-20 840 end  
gd-157 1 0 1-20 840 end  
gd-158 1 0 1-20 840 end  
gd-160 1 0 1-20 840 end  
' need the following to use endf/b5 library:  
zirc2 2 1 620 end  
'  
h2o 3 den=0.6075 1 550 end  
'  
-----
```

```

'
' mixtures of larger-unit-cell:
'
n      6 0 1-5 840 end
'
' need the following to use endf/b5 library:
zirc2 10 1 550 end
'      ....above is zircalloy casing around assembly
h2o    11 den=0.77500 1 539 end
'      ....above is channel moderator at higher density
end comp
'
' -----
'
' fuel-pin-cell geometry:
'
squarepitch 1.956 1.260 1 3 1.412 2 end
'
' -----
'
' assembly and cycle parameters:
'
' input-level=3 between geom line & powers corrects for buckling
npin/assm=36 fuelngth=2494.9 ncycles=4 nlib/cyc=1
printlevel=4 lightel=8 inplevel=3 numzones=5 end
6 0.001 500 6.6213 3 6.8521 10 7.0213 11 7.4812
bon
end
nit
end
xsd
jpdrc3 #1 buckling correction, r=63.5 & ht=147 3/29/96
i2= -2, 14, 0, 0, 0, 0, 0, 0, 0, 1,
x5= 1-4, 1-4, 1, 0, 0, 0.71, 63.5, 147,
end
power=5.7217 burn=144.33 down=534.7 end
power=5.7217 burn=144.33 down=534.7 end
power=5.7217 burn=144.33 down=534.7 end
power=5.7217 burn=144.33 down=1115.0 end
h 16.4 o 265.0 cr 2.4
mn 0.15 fe 6.6 ni 2.4
zr 516.0 sn 8.7
'
' -----
end

=sas2 parm='halt04,skipshipdata'
jpdrc bwr, assy a-14, rod c-d-3-4, node #9, 4.0351 gwd/mtu b5 7/97 4.3r
'
' -----
'
' mixtures of fuel-pin-unit-cell:
'
44group latticecell
uo2 1 den=10.13 1 840 92234 0.0153 92235 2.5966 92236 0.0161
92238 97.372 end
co-59 3 0 1-20 550 end
zr-94 1 0 1-20 840 end
nb-95 1 0 1-20 840 end
mo-95 1 0 1-20 840 end

```

```

tc-99  1 0 1-20 840  end
rh-103 1 0 1-20 840  end
rh-105 1 0 1-20 840  end
ru-106 1 0 1-20 840  end
sn-126 1 0 1-20 840  end
xe-131 1 0 1-20 840  end
cs-134 1 0 1-20 840  end
cs-135 1 0 1-20 840  end
cs-137 1 0 1-20 840  end
pr-143 1 0 1-20 840  end
nd-143 1 0 1-20 840  end
ce-144 1 0 1-20 840  end
nd-144 1 0 1-20 840  end
nd-145 1 0 1-20 840  end
nd-146 1 0 1-20 840  end
nd-147 1 0 1-20 840  end
pm-147 1 0 1-20 840  end
sm-147 1 0 1-20 840  end
nd-148 1 0 1-20 840  end
pm-148 1 0 1-20 840  end
sm-148 1 0 1-20 840  end
pm-149 1 0 1-20 840  end
sm-149 1 0 1-20 840  end
nd-150 1 0 1-20 840  end
sm-150 1 0 1-20 840  end
sm-151 1 0 1-20 840  end
eu-151 1 0 1-20 840  end
sm-152 1 0 1-20 840  end
eu-153 1 0 1-20 840  end
eu-154 1 0 1-20 840  end
gd-154 1 0 1-20 840  end
eu-155 1 0 1-20 840  end
gd-155 1 0 1-20 840  end
gd-157 1 0 1-20 840  end
gd-158 1 0 1-20 840  end
gd-160 1 0 1-20 840  end
'   need the following to use endf/b5 library:
zirc2  2 1 620  end
'
h2o   3 den=0.7541   1  550 end
'
' -----
'   mixtures of larger-unit-cell:
'
n      6 0 1-5 840  end
'
'   need the following to use endf/b5 library:
zirc2 10 1 550  end
'
'   ....above is zircalloy casing around assembly
h2o    11 den=0.77500   1  539 end
'
'   ....above is channel moderator at higher density
end comp
'
' -----
'   fuel-pin-cell geometry:
'
squarepitch  1.956  1.260  1 3  1.412  2  end
'
' -----
'   assembly and cycle parameters:
'

```

```

'      input-level=3 between geom line & powers corrects for buckling
npin/assm=36 fuelngth=2494.9 ncycles=4 nlib/cyc=1
printlevel=4 lightel=8 inplevel=3 numzones=5 end
6 0.001 500 6.6213 3 6.8521 10 7.0213 11 7.4812
bon
  end
nit
  end
xsd
jpdr c3 #1 buckling correction, r=63.5 & ht=147 3/29/96
i2= -2, 14, 0, 0, 0, 0, 0, 0, 0, 1,
x5= 1-4, 1-4, 1, 0, 0, 0.71, 63.5, 147,
  end
power=6.9895 burn=144.33 down=534.7 end
power=6.9895 burn=144.33 down=534.7 end
power=6.9895 burn=144.33 down=534.7 end
power=6.9895 burn=144.33 down=1115.0 end
      h 16.4 o 265.0 cr 2.4
      mn 0.15 fe 6.6 ni 2.4
      zr 516.0 sn 8.7
'
' -----
end

=sas2      parm='halt04,skipshipdata'
jpdr bwr, assy a-18, rod c-d-3-4, node #2, 2.7120 gwd/mtu b5 7/97 4.3r
'
' -----
' mixtures of fuel-pin-unit-cell:
'
44group      latticecell
uo2 1 den=10.13 1 840 92234 0.0153 92235 2.5966 92236 0.0161
          92238 97.372 end
co-59 3 0 1-20 550 end
zr-94 1 0 1-20 840 end
nb-95 1 0 1-20 840 end
mo-95 1 0 1-20 840 end
tc-99 1 0 1-20 840 end
rh-103 1 0 1-20 840 end
rh-105 1 0 1-20 840 end
ru-106 1 0 1-20 840 end
sn-126 1 0 1-20 840 end
xe-131 1 0 1-20 840 end
cs-134 1 0 1-20 840 end
cs-135 1 0 1-20 840 end
cs-137 1 0 1-20 840 end
pr-143 1 0 1-20 840 end
nd-143 1 0 1-20 840 end
ce-144 1 0 1-20 840 end
nd-144 1 0 1-20 840 end
nd-145 1 0 1-20 840 end
nd-146 1 0 1-20 840 end
nd-147 1 0 1-20 840 end
pm-147 1 0 1-20 840 end
sm-147 1 0 1-20 840 end
nd-148 1 0 1-20 840 end
pm-148 1 0 1-20 840 end
sm-148 1 0 1-20 840 end
pm-149 1 0 1-20 840 end

```

```

sm-149 1 0 1-20 840 end
nd-150 1 0 1-20 840 end
sm-150 1 0 1-20 840 end
sm-151 1 0 1-20 840 end
eu-151 1 0 1-20 840 end
sm-152 1 0 1-20 840 end
eu-153 1 0 1-20 840 end
eu-154 1 0 1-20 840 end
gd-154 1 0 1-20 840 end
eu-155 1 0 1-20 840 end
gd-155 1 0 1-20 840 end
gd-157 1 0 1-20 840 end
gd-158 1 0 1-20 840 end
gd-160 1 0 1-20 840 end
' need the following to use endf/b5 library:
zirc2 2 1 620 end
'
h2o 3 den=0.5629 1 550 end
'
' -----
'
' mixtures of larger-unit-cell:
'
n 6 0 1-5 840 end
'
' need the following to use endf/b5 library:
zirc2 10 1 550 end
'
' ....above is zircalloy casing around assembly
h2o 11 den=0.77500 1 539 end
'
' ....above is channel moderator at higher density
end comp
'
' -----
'
' fuel-pin-cell geometry:
'
squarepitch 1.956 1.260 1 3 1.412 2 end
'
' -----
'
' assembly and cycle parameters:
'
' input-level=3 between geom line & powers corrects for buckling
npin/assm=36 fuelngth=2494.9 ncycles=4 nlib/cyc=1
printlevel=4 lightel=8 inplevel=3 numzones=5 end
6 0.001 500 6.6213 3 6.8521 10 7.0213 11 7.4812
bon
end
nit
end
xsd
jpdrc3 #1 buckling correction, r=63.5 & ht=147 3/29/96
i2= -2, 14, 0, 0, 0, 0, 0, 0, 0, 1,
x5= 1-4, 1-4, 1, 0, 0, 0.71, 63.5, 147,
end
power=4.6976 burn=144.33 down=534.7 end
power=4.6976 burn=144.33 down=534.7 end
power=4.6976 burn=144.33 down=534.7 end
power=4.6976 burn=144.33 down=1115.0 end
h 16.4 o 265.0 cr 2.4
mn 0.15 fe 6.6 ni 2.4
zr 516.0 sn 8.7
'
' -----

```

end

```
=sas2      parm='halt04,skipshipdata'  
jldr bwr, assy a-18, rod c-d-3-4, node #6, 4.2510 gwd/mtu b5 7/97 4.3r
```

```
'  
-----  
'  
'  mixtures of fuel-pin-unit-cell:  
'  
44group      latticecell  
uo2  1 den=10.13 1 840 92234 0.0153 92235 2.5966 92236 0.0161  
      92238 97.372  end  
co-59  3 0 1-20 550  end  
zr-94  1 0 1-20 840  end  
nb-95  1 0 1-20 840  end  
mo-95  1 0 1-20 840  end  
tc-99  1 0 1-20 840  end  
rh-103 1 0 1-20 840  end  
rh-105 1 0 1-20 840  end  
ru-106 1 0 1-20 840  end  
sn-126 1 0 1-20 840  end  
xe-131 1 0 1-20 840  end  
cs-134 1 0 1-20 840  end  
cs-135 1 0 1-20 840  end  
cs-137 1 0 1-20 840  end  
pr-143 1 0 1-20 840  end  
nd-143 1 0 1-20 840  end  
ce-144 1 0 1-20 840  end  
nd-144 1 0 1-20 840  end  
nd-145 1 0 1-20 840  end  
nd-146 1 0 1-20 840  end  
nd-147 1 0 1-20 840  end  
pm-147 1 0 1-20 840  end  
sm-147 1 0 1-20 840  end  
nd-148 1 0 1-20 840  end  
pm-148 1 0 1-20 840  end  
sm-148 1 0 1-20 840  end  
pm-149 1 0 1-20 840  end  
sm-149 1 0 1-20 840  end  
nd-150 1 0 1-20 840  end  
sm-150 1 0 1-20 840  end  
sm-151 1 0 1-20 840  end  
eu-151 1 0 1-20 840  end  
sm-152 1 0 1-20 840  end  
eu-153 1 0 1-20 840  end  
eu-154 1 0 1-20 840  end  
gd-154 1 0 1-20 840  end  
eu-155 1 0 1-20 840  end  
gd-155 1 0 1-20 840  end  
gd-157 1 0 1-20 840  end  
gd-158 1 0 1-20 840  end  
gd-160 1 0 1-20 840  end  
'  need the following to use endf/b5 library:  
zirc2  2 1 620  end  
'  
h2o  3 den=0.6708  1 550  end  
'  
-----  
'  mixtures of larger-unit-cell:
```

```

'
n          6 0 1-5 840 end
'
' need the following to use endf/b5 library:
zirc2 10 1 550 end
'
' ....above is zircalloy casing around assembly
h2o      11 den=0.77500 1 539 end
'
' channel region at full density
end comp
'
' -----
'
' fuel-pin-cell geometry:
'
squarepitch 1.956 1.260 1 3 1.412 2 end
'
' -----
'
' assembly and cycle parameters:
'
' input-level=3 between geom line & powers corrects for buckling
npin/assm=36 fuelngth=2494.9 ncycles=4 nlib/cyc=1
printlevel=4 lightel=8 inplevel=3 numzones=5 end
6 0.001 500 6.6213 3 6.8521 10 7.0213 11 7.4812
bon
end
nit
end
xsd
jpdr c3 #1 buckling correction, r=63.5 & ht=147 3/29/96
i2= -2, 14, 0, 0, 0, 0, 0, 0, 0, 1,
x5= 1-4, 1-4, 1, 0, 0, 0.71, 63.5, 147,
end
power=7.3634 burn=144.33 down=534.7 end
power=7.3634 burn=144.33 down=534.7 end
power=7.3634 burn=144.33 down=534.7 end
power=7.3634 burn=144.33 down=1115.0 end
h 16.4 o 265.0 cr 2.4
mn 0.15 fe 6.6 ni 2.4
zr 516.0 sn 8.7
'
' -----
end

=sas2 parm='halt04,skipshipdata'
jpdr bwr, assy a-20, rod a-1, node #3, 7.0098 gwd/mtu b5 7/97 4.3r
'
' -----
'
' mixtures of fuel-pin-unit-cell:
'
44group latticecell
uo2 1 den=10.13 1 840 92234 0.0153 92235 2.5966 92236 0.0161
92238 97.372 end
co-59 3 0 1-20 550 end
zr-94 1 0 1-20 840 end
nb-95 1 0 1-20 840 end
mo-95 1 0 1-20 840 end
tc-99 1 0 1-20 840 end
rh-103 1 0 1-20 840 end

```



```

rh-105 1 0 1-20 840 end
ru-106 1 0 1-20 840 end
sn-126 1 0 1-20 840 end
xe-131 1 0 1-20 840 end
cs-134 1 0 1-20 840 end
cs-135 1 0 1-20 840 end
cs-137 1 0 1-20 840 end
pr-143 1 0 1-20 840 end
nd-143 1 0 1-20 840 end
ce-144 1 0 1-20 840 end
nd-144 1 0 1-20 840 end
nd-145 1 0 1-20 840 end
nd-146 1 0 1-20 840 end
nd-147 1 0 1-20 840 end
pm-147 1 0 1-20 840 end
sm-147 1 0 1-20 840 end
nd-148 1 0 1-20 840 end
pm-148 1 0 1-20 840 end
sm-148 1 0 1-20 840 end
pm-149 1 0 1-20 840 end
sm-149 1 0 1-20 840 end
nd-150 1 0 1-20 840 end
sm-150 1 0 1-20 840 end
sm-151 1 0 1-20 840 end
eu-151 1 0 1-20 840 end
sm-152 1 0 1-20 840 end
eu-153 1 0 1-20 840 end
eu-154 1 0 1-20 840 end
gd-154 1 0 1-20 840 end
eu-155 1 0 1-20 840 end
gd-155 1 0 1-20 840 end
gd-157 1 0 1-20 840 end
gd-158 1 0 1-20 840 end
gd-160 1 0 1-20 840 end
' need the following to use endf/b5 library:
zirc2 2 1 620 end
'
h2o 3 den=0.6719 1 550 end
'
' -----
'
' mixtures of larger-unit-cell:
'
n 6 0 1-5 840 end
'
' need the following to use endf/b5 library:
zirc2 10 1 550 end
'
h2o 11 den=0.77500 1 539 end
'
' ....above is zircalloy casing around assembly
'
' ....above is channel moderator at higher density
end comp
'
' -----
'
' fuel-pin-cell geometry:
'
squarepitch 1.956 1.260 1 3 1.412 2 end
'
' -----
'
' assembly and cycle parameters:
'
input-level=3 between geom line & powers corrects for buckling
npin/assm=36 fuelngth=2494.9 ncycles=4 nlib/cyc=1

```

```

printlevel=4 lightel=8 inplevel=3 numzones=5 end
6 0.001 500 6.6213 3 6.8521 10 7.0213 11 7.4812
bon
  end
nit
  end
xsd
jldr c3 #1 buckling correction, r=63.5 & ht=147 3/29/96
i2= -2, 14, 0, 0, 0, 0, 0, 0, 0, 1,
x5= 1-4, 1-4, 1, 0, 0, 0.71, 63.5, 147,
  end
power=12.1423 burn=144.33 down=534.7 end
power=12.1423 burn=144.33 down=534.7 end
power=12.1423 burn=144.33 down=534.7 end
power=12.1423 burn=144.33 down=1430.0 end
      h 16.4      o 265.0      cr 2.4
      mn 0.15     fe 6.6       ni 2.4
      zr 516.0    sn 8.7
,
' - - - - -
end

=sas2      parm='halt04,skipshipdata'
jldr bwr, assy a-20, rod a-3, node #10, 6.1465 gwd/mtu b5 7/97 4.3r
,
' - - - - -
,
      mixtures of fuel-pin-unit-cell:
,
44group      latticecell
uo2 1 den=10.13 1 840 92234 0.0153 92235 2.5966 92236 0.0161
          92238 97.372 end
co-59 3 0 1-20 550 end
zr-94 1 0 1-20 840 end
nb-95 1 0 1-20 840 end
mo-95 1 0 1-20 840 end
tc-99 1 0 1-20 840 end
rh-103 1 0 1-20 840 end
rh-105 1 0 1-20 840 end
ru-106 1 0 1-20 840 end
sn-126 1 0 1-20 840 end
xe-131 1 0 1-20 840 end
cs-134 1 0 1-20 840 end
cs-135 1 0 1-20 840 end
cs-137 1 0 1-20 840 end
pr-143 1 0 1-20 840 end
nd-143 1 0 1-20 840 end
ce-144 1 0 1-20 840 end
nd-144 1 0 1-20 840 end
nd-145 1 0 1-20 840 end
nd-146 1 0 1-20 840 end
nd-147 1 0 1-20 840 end
pm-147 1 0 1-20 840 end
sm-147 1 0 1-20 840 end
nd-148 1 0 1-20 840 end
pm-148 1 0 1-20 840 end
sm-148 1 0 1-20 840 end
pm-149 1 0 1-20 840 end
sm-149 1 0 1-20 840 end
nd-150 1 0 1-20 840 end

```

```

sm-150 1 0 1-20 840 end
sm-151 1 0 1-20 840 end
eu-151 1 0 1-20 840 end
sm-152 1 0 1-20 840 end
eu-153 1 0 1-20 840 end
eu-154 1 0 1-20 840 end
gd-154 1 0 1-20 840 end
eu-155 1 0 1-20 840 end
gd-155 1 0 1-20 840 end
gd-157 1 0 1-20 840 end
gd-158 1 0 1-20 840 end
gd-160 1 0 1-20 840 end
' need the following to use endf/b5 library:
zirc2 2 1 620 end
'
h2o 3 den=0.7642 1 550 end
'
' -----
'
' mixtures of larger-unit-cell:
'
n 6 0 1-5 840 end
'
' need the following to use endf/b5 library:
zirc2 10 1 550 end
'
' ....above is zircalloy casing around assembly
h2o 11 den=0.77500 1 539 end
'
' ....above is channel moderator at higher density
end comp
'
' -----
'
' fuel-pin-cell geometry:
'
squarepitch 1.956 1.260 1 3 1.412 2 end
'
' -----
'
' assembly and cycle parameters:
'
' input-level=3 between geom line & powers corrects for buckling
npin/assm=36 fuelngth=2494.9 ncycles=4 nlib/cyc=1
printlevel=4 lightel=8 inplevel=3 numzones=5 end
6 0.001 500 6.6213 3 6.8521 10 7.0213 11 7.4812
bon
end
nit
end
xsd
jpdr c3 #1 buckling correction, r=63.5 & ht=147 3/29/96
i2= -2, 14, 0, 0, 0, 0, 0, 0, 0, 1,
x5= 1-4, 1-4, 1, 0, 0, 0.71, 63.5, 147,
end
power=10.6468 burn=144.33 down=534.7 end
power=10.6468 burn=144.33 down=534.7 end
power=10.6468 burn=144.33 down=534.7 end
power=10.6468 burn=144.33 down=1430.0 end
h 16.4 o 265.0 cr 2.4
mn 0.15 fe 6.6 ni 2.4
zr 516.0 sn 8.7
'
' -----
end

```

```

=sas2      parm='halt04,skipshipdata'
jpdrr bwr, assy a-20, rod a-6, node #3, 6.9535 gwd/mtu b5 7/97 4.3r
'
'-----
'
'   mixtures of fuel-pin-unit-cell:
'
44group      latticecell
uo2  1 den=10.13 1 840 92234 0.0153 92235 2.5966 92236 0.0161
      92238 97.372  end
co-59  3 0 1-20 550  end
zr-94  1 0 1-20 840  end
nb-95  1 0 1-20 840  end
mo-95  1 0 1-20 840  end
tc-99  1 0 1-20 840  end
rh-103 1 0 1-20 840  end
rh-105 1 0 1-20 840  end
ru-106 1 0 1-20 840  end
sn-126 1 0 1-20 840  end
xe-131 1 0 1-20 840  end
cs-134 1 0 1-20 840  end
cs-135 1 0 1-20 840  end
cs-137 1 0 1-20 840  end
pr-143 1 0 1-20 840  end
nd-143 1 0 1-20 840  end
ce-144 1 0 1-20 840  end
nd-144 1 0 1-20 840  end
nd-145 1 0 1-20 840  end
nd-146 1 0 1-20 840  end
nd-147 1 0 1-20 840  end
pm-147 1 0 1-20 840  end
sm-147 1 0 1-20 840  end
nd-148 1 0 1-20 840  end
pm-148 1 0 1-20 840  end
sm-148 1 0 1-20 840  end
pm-149 1 0 1-20 840  end
sm-149 1 0 1-20 840  end
nd-150 1 0 1-20 840  end
sm-150 1 0 1-20 840  end
sm-151 1 0 1-20 840  end
eu-151 1 0 1-20 840  end
sm-152 1 0 1-20 840  end
eu-153 1 0 1-20 840  end
eu-154 1 0 1-20 840  end
gd-154 1 0 1-20 840  end
eu-155 1 0 1-20 840  end
gd-155 1 0 1-20 840  end
gd-157 1 0 1-20 840  end
gd-158 1 0 1-20 840  end
gd-160 1 0 1-20 840  end
'   need the following to use endf/b5 library:
zirc2  2 1 620  end
'
h2o  3 den=0.6719 1 550 end
'
'-----
'
'   mixtures of larger-unit-cell:
'
n      6 0 1-5 840  end

```

```

'
' need the following to use endf/b5 library:
zirc2 10 1 550 end
'
' ....above is zircalloy casing around assembly
h2o      11  den=0.77500  1  539 end
'
' ....above is channel moderator at higher density
end comp
'
' -----
'
' fuel-pin-cell geometry:
squarepitch  1.956  1.260  1 3  1.412  2  end
'
' -----
'
' assembly and cycle parameters:
'
' input-level=3 between geom line & powers corrects for buckling
npin/assm=36 fuelngth=2494.9 ncycles=4 nlib/cyc=1
printlevel=4 lightel=8 inplevel=3 numzones=5 end
6 0.001 500 6.6213 3 6.8521 10 7.0213 11 7.4812
bon
end
nit
end
xsd
jpdr c3 #1 buckling correction, r=63.5 & ht=147 3/29/96
i2= -2, 14, 0, 0, 0, 0, 0, 0, 0, 1,
x5= 1-4, 1-4, 1, 0, 0, 0.71, 63.5, 147,
end
power=12.0447 burn=144.33 down=534.7 end
power=12.0447 burn=144.33 down=534.7 end
power=12.0447 burn=144.33 down=534.7 end
power=12.0447 burn=144.33 down=1430.0 end
h 16.4 o 265.0 cr 2.4
mn 0.15 fe 6.6 ni 2.4
zr 516.0 sn 8.7
'
' -----
end

=sas2 parm='halt04,skipshipdata'
jpdr bwr, assy a-20, rod a-6, node #9, 6.5125 gwd/mtu b5 7/97 4.3r
'
' -----
'
' mixtures of fuel-pin-unit-cell:
'
44group latticecell
uo2 1 den=10.13 1 840 92234 0.0153 92235 2.5966 92236 0.0161
92238 97.372 end
co-59 3 0 1-20 550 end
zr-94 1 0 1-20 840 end
nb-95 1 0 1-20 840 end
mo-95 1 0 1-20 840 end
tc-99 1 0 1-20 840 end
rh-103 1 0 1-20 840 end
rh-105 1 0 1-20 840 end
ru-106 1 0 1-20 840 end

```

```

sn-126 1 0 1-20 840 end
xe-131 1 0 1-20 840 end
cs-134 1 0 1-20 840 end
cs-135 1 0 1-20 840 end
cs-137 1 0 1-20 840 end
pr-143 1 0 1-20 840 end
nd-143 1 0 1-20 840 end
ce-144 1 0 1-20 840 end
nd-144 1 0 1-20 840 end
nd-145 1 0 1-20 840 end
nd-146 1 0 1-20 840 end
nd-147 1 0 1-20 840 end
pm-147 1 0 1-20 840 end
sm-147 1 0 1-20 840 end
nd-148 1 0 1-20 840 end
pm-148 1 0 1-20 840 end
sm-148 1 0 1-20 840 end
pm-149 1 0 1-20 840 end
sm-149 1 0 1-20 840 end
nd-150 1 0 1-20 840 end
sm-150 1 0 1-20 840 end
sm-151 1 0 1-20 840 end
eu-151 1 0 1-20 840 end
sm-152 1 0 1-20 840 end
eu-153 1 0 1-20 840 end
eu-154 1 0 1-20 840 end
gd-154 1 0 1-20 840 end
eu-155 1 0 1-20 840 end
gd-155 1 0 1-20 840 end
gd-157 1 0 1-20 840 end
gd-158 1 0 1-20 840 end
gd-160 1 0 1-20 840 end
' need the following to use endf/b5 library:
zirc2 2 1 620 end
'
h2o 3 den=0.7600 1 550 end
'
' -----
'
' mixtures of larger-unit-cell:
'
n 6 0 1-5 840 end
'
' need the following to use endf/b5 library:
zirc2 10 1 550 end
'
' ....above is zircalloy casing around assembly
h2o 11 den=0.77500 1 539 end
'
' ....above is channel moderator at higher density
end comp
'
' -----
'
' fuel-pin-cell geometry:
'
squarepitch 1.956 1.260 1 3 1.412 2 end
'
' -----
'
' assembly and cycle parameters:
'
' input-level=3 between geom line & powers corrects for buckling
npin/assm=36 fuelngth=2494.9 ncycles=4 nlib/cyc=1
printlevel=4 lightel=8 inplevel=3 numzones=5 end
6 0.001 500 6.6213 3 6.8521 10 7.0213 11 7.4812

```

```

bon
  end
nit
  end
xsd
jpdrc3 #1 buckling correction, r=63.5 & ht=147 3/29/96
i2= -2, 14, 0, 0, 0, 0, 0, 0, 0, 1,
x5= 1-4, 1-4, 1, 0, 0, 0.71, 63.5, 147,
  end
power=11.2808 burn=144.33 down=534.7 end
power=11.2808 burn=144.33 down=534.7 end
power=11.2808 burn=144.33 down=534.7 end
power=11.2808 burn=144.33 down=1430.0 end
  h 16.4 o 265.0 cr 2.4
  mn 0.15 fe 6.6 ni 2.4
  zr 516.0 sn 8.7
'
' -----
end

=sas2 parm='halt04,skipshipdata'
jpdrc bwr, assy a-20, rod c-3, node #1, 2.6463 gwd/mtu b5 7/97 4.3r
'
' -----
'
' mixtures of fuel-pin-unit-cell:
'
44group latticecell
uo2 1 den=10.13 1 840 92234 0.0153 92235 2.5966 92236 0.0161
      92238 97.372 end
co-59 3 0 1-20 550 end
zr-94 1 0 1-20 840 end
nb-95 1 0 1-20 840 end
mo-95 1 0 1-20 840 end
tc-99 1 0 1-20 840 end
rh-103 1 0 1-20 840 end
rh-105 1 0 1-20 840 end
ru-106 1 0 1-20 840 end
sn-126 1 0 1-20 840 end
xe-131 1 0 1-20 840 end
cs-134 1 0 1-20 840 end
cs-135 1 0 1-20 840 end
cs-137 1 0 1-20 840 end
pr-143 1 0 1-20 840 end
nd-143 1 0 1-20 840 end
ce-144 1 0 1-20 840 end
nd-144 1 0 1-20 840 end
nd-145 1 0 1-20 840 end
nd-146 1 0 1-20 840 end
nd-147 1 0 1-20 840 end
pm-147 1 0 1-20 840 end
sm-147 1 0 1-20 840 end
nd-148 1 0 1-20 840 end
pm-148 1 0 1-20 840 end
sm-148 1 0 1-20 840 end
pm-149 1 0 1-20 840 end
sm-149 1 0 1-20 840 end
nd-150 1 0 1-20 840 end
sm-150 1 0 1-20 840 end
sm-151 1 0 1-20 840 end

```

```

eu-151 1 0 1-20 840 end
sm-152 1 0 1-20 840 end
eu-153 1 0 1-20 840 end
eu-154 1 0 1-20 840 end
gd-154 1 0 1-20 840 end
eu-155 1 0 1-20 840 end
gd-155 1 0 1-20 840 end
gd-157 1 0 1-20 840 end
gd-158 1 0 1-20 840 end
gd-160 1 0 1-20 840 end
' need the following to use endf/b5 library:
zirc2 2 1 620 end
'
h2o 3 den=0.5232 1 550 end
'
' -----
'
' mixtures of larger-unit-cell:
'
n 6 0 1-5 840 end
'
' need the following to use endf/b5 library:
zirc2 10 1 550 end
'
' ....above is zircalloy casing around assembly
h2o 11 den=0.77500 1 539 end
'
' ....above is channel moderator at higher density
end comp
'
' -----
'
' fuel-pin-cell geometry:
'
squarepitch 1.956 1.260 1 3 1.412 2 end
'
' -----
'
' assembly and cycle parameters:
'
' input-level=3 between geom line & powers corrects for buckling
npin/assm=36 fuelngth=2494.9 ncycles=4 nlib/cyc=1
printlevel=4 lightel=8 inplevel=3 numzones=5 end
6 0.001 500 6.6213 3 6.8521 10 7.0213 11 7.4812
bon
end
nit
end
xsd
jpdrc3 #1 buckling correction, r=63.5 & ht=147 3/29/96
i2= -2, 14, 0, 0, 0, 0, 0, 0, 0, 1,
x5= 1-4, 1-4, 1, 0, 0, 0.71, 63.5, 147,
end
power=4.5838 burn=144.33 down=534.7 end
power=4.5838 burn=144.33 down=534.7 end
power=4.5838 burn=144.33 down=534.7 end
power=4.5838 burn=144.33 down=1430.0 end
h 16.4 o 265.0 cr 2.4
mn 0.15 fe 6.6 ni 2.4
zr 516.0 sn 8.7
'
' -----
end

```



```

=sas2      parm='halt04,skipshipdata'
jpdrr bwr, assy a-20, rod c-3, #3 at 114.885 cm, 5.0861 gwd/mtu b5 7/97 4.3r
'
'-----
'
'   mixtures of fuel-pin-unit-cell:
'
44group      latticecell
uo2  1 den=10.13 1 840 92234 0.0153 92235 2.5966 92236 0.0161
      92238 97.372  end
co-59  3 0 1-20 550  end
zr-94  1 0 1-20 840  end
nb-95  1 0 1-20 840  end
mo-95  1 0 1-20 840  end
tc-99  1 0 1-20 840  end
rh-103 1 0 1-20 840  end
rh-105 1 0 1-20 840  end
ru-106 1 0 1-20 840  end
sn-126 1 0 1-20 840  end
xe-131 1 0 1-20 840  end
cs-134 1 0 1-20 840  end
cs-135 1 0 1-20 840  end
cs-137 1 0 1-20 840  end
pr-143 1 0 1-20 840  end
nd-143 1 0 1-20 840  end
ce-144 1 0 1-20 840  end
nd-144 1 0 1-20 840  end
nd-145 1 0 1-20 840  end
nd-146 1 0 1-20 840  end
nd-147 1 0 1-20 840  end
pm-147 1 0 1-20 840  end
sm-147 1 0 1-20 840  end
nd-148 1 0 1-20 840  end
pm-148 1 0 1-20 840  end
sm-148 1 0 1-20 840  end
pm-149 1 0 1-20 840  end
sm-149 1 0 1-20 840  end
nd-150 1 0 1-20 840  end
sm-150 1 0 1-20 840  end
sm-151 1 0 1-20 840  end
eu-151 1 0 1-20 840  end
sm-152 1 0 1-20 840  end
eu-153 1 0 1-20 840  end
eu-154 1 0 1-20 840  end
gd-154 1 0 1-20 840  end
eu-155 1 0 1-20 840  end
gd-155 1 0 1-20 840  end
gd-157 1 0 1-20 840  end
gd-158 1 0 1-20 840  end
gd-160 1 0 1-20 840  end
'   need the following to use endf/b5 library:
zirc2  2 1 620  end
'
h2o  3 den=0.5688  1 550 end
'
'-----
'
'   mixtures of larger-unit-cell:
'
n      6 0 1-5 840  end
'
'   need the following to use endf/b5 library:

```

```

zirc2 10 1 550 end
'
'      ....above is zircalloy casing around assembly
h2o      11 den=0.77500 1 539 end
'
'      ....above is channel moderator at higher density
end comp
'
' -----
'
'      fuel-pin-cell geometry:
'
squarepitch 1.956 1.260 1 3 1.412 2 end
'
' -----
'
'      assembly and cycle parameters:
'
'      input-level=3 between geom line & powers corrects for buckling
npin/assm=36 fuelngth=2494.9 ncycles=4 nlib/cyc=1
printlevel=4 lightel=8 inplevel=3 numzones=5 end
6 0.001 500 6.6213 3 6.8521 10 7.0213 11 7.4812
bon
end
nit
end
xsd
jpdr c3 #1 buckling correction, r=63.5 & ht=147 3/29/96
i2= -2, 14, 0, 0, 0, 0, 0, 0, 0, 1,
x5= 1-4, 1-4, 1, 0, 0, 0.71, 63.5, 147,
end
power=8.810 burn=144.33 down=534.7 end
power=8.810 burn=144.33 down=534.7 end
power=8.810 burn=144.33 down=534.7 end
power=8.810 burn=144.33 down=1430.0 end
h 16.4 o 265.0 cr 2.4
mn 0.15 fe 6.6 ni 2.4
zr 516.0 sn 8.7
'
' -----
end

=sas2 parm='halt04,skipshipdata'
jpdr bwr, assy a-20, rod c-3, node #5, 6.0808 gwd/mtu b5 7/97 4.3r
'
' -----
'
'      mixtures of fuel-pin-unit-cell:
'
44group latticecell
uo2 1 den=10.13 1 840 92234 0.0153 92235 2.5966 92236 0.0161
92238 97.372 end
co-59 3 0 1-20 550 end
zr-94 1 0 1-20 840 end
nb-95 1 0 1-20 840 end
mo-95 1 0 1-20 840 end
tc-99 1 0 1-20 840 end
rh-103 1 0 1-20 840 end
rh-105 1 0 1-20 840 end
ru-106 1 0 1-20 840 end
sn-126 1 0 1-20 840 end
xe-131 1 0 1-20 840 end

```

```

cs-134 1 0 1-20 840 end
cs-135 1 0 1-20 840 end
cs-137 1 0 1-20 840 end
pr-143 1 0 1-20 840 end
nd-143 1 0 1-20 840 end
ce-144 1 0 1-20 840 end
nd-144 1 0 1-20 840 end
nd-145 1 0 1-20 840 end
nd-146 1 0 1-20 840 end
nd-147 1 0 1-20 840 end
pm-147 1 0 1-20 840 end
sm-147 1 0 1-20 840 end
nd-148 1 0 1-20 840 end
pm-148 1 0 1-20 840 end
sm-148 1 0 1-20 840 end
pm-149 1 0 1-20 840 end
sm-149 1 0 1-20 840 end
nd-150 1 0 1-20 840 end
sm-150 1 0 1-20 840 end
sm-151 1 0 1-20 840 end
eu-151 1 0 1-20 840 end
sm-152 1 0 1-20 840 end
eu-153 1 0 1-20 840 end
eu-154 1 0 1-20 840 end
gd-154 1 0 1-20 840 end
eu-155 1 0 1-20 840 end
gd-155 1 0 1-20 840 end
gd-157 1 0 1-20 840 end
gd-158 1 0 1-20 840 end
gd-160 1 0 1-20 840 end
' need the following to use endf/b5 library:
zirc2 2 1 620 end
'
h2o 3 den=0.6276 1 550 end
'
' -----
'
' mixtures of larger-unit-cell:
'
n 6 0 1-5 840 end
'
' need the following to use endf/b5 library:
zirc2 10 1 550 end
'
' ....above is zircalloy casing around assembly
h2o 11 den=0.77500 1 539 end
'
' ....above is channel moderator at higher density
end comp
'
' -----
'
' fuel-pin-cell geometry:
'
squarepitch 1.956 1.260 1 3 1.412 2 end
'
' -----
'
' assembly and cycle parameters:
'
' input-level=3 between geom line & powers corrects for buckling
npin/assm=36 fuelngth=2494.9 ncycles=4 nlib/cyc=1
printlevel=4 lightel=8 inplevel=3 numzones=5 end
6 0.001 500 6.6213 3 6.8521 10 7.0213 11 7.4812
bon
end

```

```

nit
end
xsd
jpdR c3 #1 buckling correction, r=63.5 & ht=147 3/29/96
i2= -2, 14, 0, 0, 0, 0, 0, 0, 0, 1,
x5= 1-4, 1-4, 1, 0, 0, 0.71, 63.5, 147,
end
power=10.5330 burn=144.33 down=534.7 end
power=10.5330 burn=144.33 down=534.7 end
power=10.5330 burn=144.33 down=534.7 end
power=10.5330 burn=144.33 down=1430.0 end
h 16.4 o 265.0 cr 2.4
mn 0.15 fe 6.6 ni 2.4
zr 516.0 sn 8.7
'
'
-----
end

=sas2 parm='halt04,skipshipdata'
jpdR bwr, assy a-20, rod c-3, node #8, 6.0433 gwd/mtu b5 7/97 4.3r
'
'
-----
'
mixtures of fuel-pin-unit-cell:
'
44group latticecell
uo2 1 den=10.13 1 840 92234 0.0153 92235 2.5966 92236 0.0161
92238 97.372 end
co-59 3 0 1-20 550 end
zr-94 1 0 1-20 840 end
nb-95 1 0 1-20 840 end
mo-95 1 0 1-20 840 end
tc-99 1 0 1-20 840 end
rh-103 1 0 1-20 840 end
rh-105 1 0 1-20 840 end
ru-106 1 0 1-20 840 end
sn-126 1 0 1-20 840 end
xe-131 1 0 1-20 840 end
cs-134 1 0 1-20 840 end
cs-135 1 0 1-20 840 end
cs-137 1 0 1-20 840 end
pr-143 1 0 1-20 840 end
nd-143 1 0 1-20 840 end
ce-144 1 0 1-20 840 end
nd-144 1 0 1-20 840 end
nd-145 1 0 1-20 840 end
nd-146 1 0 1-20 840 end
nd-147 1 0 1-20 840 end
pm-147 1 0 1-20 840 end
sm-147 1 0 1-20 840 end
nd-148 1 0 1-20 840 end
pm-148 1 0 1-20 840 end
sm-148 1 0 1-20 840 end
pm-149 1 0 1-20 840 end
sm-149 1 0 1-20 840 end
nd-150 1 0 1-20 840 end
sm-150 1 0 1-20 840 end
sm-151 1 0 1-20 840 end
eu-151 1 0 1-20 840 end
sm-152 1 0 1-20 840 end

```

```

eu-153 1 0 1-20 840 end
eu-154 1 0 1-20 840 end
gd-154 1 0 1-20 840 end
eu-155 1 0 1-20 840 end
gd-155 1 0 1-20 840 end
gd-157 1 0 1-20 840 end
gd-158 1 0 1-20 840 end
gd-160 1 0 1-20 840 end

' need the following to use endf/b5 library:
zirc2 2 1 620 end
h2o 3 den=0.7305 1 550 end
'
' -----
'
' mixtures of larger-unit-cell:
'
n 6 0 1-5 840 end
'
' need the following to use endf/b5 library:
zirc2 10 1 550 end
' ....above is zircalloy casing around assembly
h2o 11 den=0.77500 1 539 end
' ....above is channel moderator at higher density
end comp
'
' -----
'
' fuel-pin-cell geometry:
'
squarepitch 1.956 1.260 1 3 1.412 2 end
'
' -----
'
' assembly and cycle parameters:
'
' input-level=3 between geom line & powers corrects for buckling
npin/assm=36 fuelngth=2494.9 ncycles=4 nlib/cyc=1
printlevel=4 lightel=8 inplevel=3 numzones=5 end
6 0.001 500 6.6213 3 6.8521 10 7.0213 11 7.4812
bon
end
nit
end
xsd
jpdrc3 #1 buckling correction, r=63.5 & ht=147 3/29/96
i2= -2, 14, 0, 0, 0, 0, 0, 0, 0, 1,
x5= 1-4, 1-4, 1, 0, 0, 0.71, 63.5, 147,
end
power=10.4680 burn=144.33 down=534.7 end
power=10.4680 burn=144.33 down=534.7 end
power=10.4680 burn=144.33 down=534.7 end
power=10.4680 burn=144.33 down=1430.0 end
h 16.4 o 265.0 cr 2.4
mn 0.15 fe 6.6 ni 2.4
zr 516.0 sn 8.7
'
' -----
end

```

```

=sas2      parm='halt04,skipshipdata'
jprdr bwr, assy a-20, rod c-3, #10 at 31.785 cm, 5.0580 gwd/mtu b5 7/97 4.3r
'
'-----
'
'   mixtures of fuel-pin-unit-cell:
'
44group      latticecell
uo2  1 den=10.13 1  840  92234  0.0153  92235  2.5966  92236  0.0161
      92238 97.372   end
co-59  3 0 1-20 550  end
zr-94  1 0 1-20 840  end
nb-95  1 0 1-20 840  end
mo-95  1 0 1-20 840  end
tc-99  1 0 1-20 840  end
rh-103 1 0 1-20 840  end
rh-105 1 0 1-20 840  end
ru-106 1 0 1-20 840  end
sn-126 1 0 1-20 840  end
xe-131 1 0 1-20 840  end
cs-134 1 0 1-20 840  end
cs-135 1 0 1-20 840  end
cs-137 1 0 1-20 840  end
pr-143 1 0 1-20 840  end
nd-143 1 0 1-20 840  end
ce-144 1 0 1-20 840  end
nd-144 1 0 1-20 840  end
nd-145 1 0 1-20 840  end
nd-146 1 0 1-20 840  end
nd-147 1 0 1-20 840  end
pm-147 1 0 1-20 840  end
sm-147 1 0 1-20 840  end
nd-148 1 0 1-20 840  end
pm-148 1 0 1-20 840  end
sm-148 1 0 1-20 840  end
pm-149 1 0 1-20 840  end
sm-149 1 0 1-20 840  end
nd-150 1 0 1-20 840  end
sm-150 1 0 1-20 840  end
sm-151 1 0 1-20 840  end
eu-151 1 0 1-20 840  end
sm-152 1 0 1-20 840  end
eu-153 1 0 1-20 840  end
eu-154 1 0 1-20 840  end
gd-154 1 0 1-20 840  end
eu-155 1 0 1-20 840  end
gd-155 1 0 1-20 840  end
gd-157 1 0 1-20 840  end
gd-158 1 0 1-20 840  end
gd-160 1 0 1-20 840  end
'   need the following to use endf/b5 library:
zirc2  2 1 620  end
'
h2o  3 den=0.7534 1  550  end
'
'-----
'
'   mixtures of larger-unit-cell:
'
n      6 0 1-5 840  end
'
'   need the following to use endf/b5 library:
zirc2  10 1 550  end
'
'   ....above is zircalloy casing around assembly

```

```

h2o      11   den=0.77500   1   539 end
'
'         ....above s channel moderator at higher density
end comp
'
' -----
'
'         fuel-pin-cell geometry:
'
squarepitch  1.956  1.260   1 3  1.412  2  end
'
' -----
'
'         assembly and cycle parameters:
'
'         input-level=3 between geom line & powers corrects for buckling
npin/assm=36 fuelngth=2494.9 ncycles=4 nlib/cyc=1
printlevel=4 lightel=8 inplevel=3 numzones=5  end
6 0.001  500 6.6213  3 6.8521  10 7.0213  11 7.4812
bon
end
nit
end
xsd
jpdrc c3 #1 buckling correction, r=63.5 & ht=147  3/29/96
i2= -2, 14, 0, 0, 0,  0, 0, 0, 0, 1,
x5= 1-4, 1-4, 1, 0, 0,  0.71,  63.5, 147,
end
power=8.7613 burn=144.33 down=534.7 end
power=8.7613 burn=144.33 down=534.7 end
power=8.7613 burn=144.33 down=534.7 end
power=8.7613 burn=144.33 down=1430.0 end
      h  16.4   o 265.0   cr  2.4
      mn 0.15  fe  6.6   ni  2.4
      zr 516.0  sn  8.7
'
' -----
end

=sas2      parm='halt04,skipshipdata'
jpdrc bwr, assy a-20, rod c-3, #12 at 7.346 cm, 2.1583 gwd/mtu b5 7/97 4.3r
'
' -----
'
'         mixtures of fuel-pin-unit-cell:
'
44group      latticecell
uo2  1 den=10.13 1 840 92234 0.0153 92235 2.5966 92236 0.0161
      92238 97.372  end
co-59  3 0 1-20 550  end
zr-94  1 0 1-20 840  end
nb-95  1 0 1-20 840  end
mo-95  1 0 1-20 840  end
tc-99  1 0 1-20 840  end
rh-103 1 0 1-20 840  end
rh-105 1 0 1-20 840  end
ru-106 1 0 1-20 840  end
sn-126 1 0 1-20 840  end
xe-131 1 0 1-20 840  end
cs-134 1 0 1-20 840  end
cs-135 1 0 1-20 840  end

```

```

cs-137 1 0 1-20 840 end
pr-143 1 0 1-20 840 end
nd-143 1 0 1-20 840 end
ce-144 1 0 1-20 840 end
nd-144 1 0 1-20 840 end
nd-145 1 0 1-20 840 end
nd-146 1 0 1-20 840 end
nd-147 1 0 1-20 840 end
pm-147 1 0 1-20 840 end
sm-147 1 0 1-20 840 end
nd-148 1 0 1-20 840 end
pm-148 1 0 1-20 840 end
sm-148 1 0 1-20 840 end
pm-149 1 0 1-20 840 end
sm-149 1 0 1-20 840 end
nd-150 1 0 1-20 840 end
sm-150 1 0 1-20 840 end
sm-151 1 0 1-20 840 end
eu-151 1 0 1-20 840 end
sm-152 1 0 1-20 840 end
eu-153 1 0 1-20 840 end
eu-154 1 0 1-20 840 end
gd-154 1 0 1-20 840 end
eu-155 1 0 1-20 840 end
gd-155 1 0 1-20 840 end
gd-157 1 0 1-20 840 end
gd-158 1 0 1-20 840 end
gd-160 1 0 1-20 840 end
' need the following to use endf/b5 library:
zirc2 2 1 620 end
'
h2o 3 den=0.7701 1 550 end
'
' -----
'
' mixtures of larger-unit-cell:
'
n 6 0 1-5 840 end
'
' need the following to use endf/b5 library:
zirc2 10 1 550 end
'
' ....above is zircalloy casing around assembly
h2o 11 den=0.77500 1 539 end
'
' ....above is channel moderator at higher density
end comp
'
' -----
'
' fuel-pin-cell geometry:
'
squarepitch 1.956 1.260 1 3 1.412 2 end
'
' -----
'
' assembly and cycle parameters:
'
' input-level=3 between geom line & powers corrects for buckling
npin/assm=36 fuelngth=2494.9 ncycles=4 nlib/cyc=1
printlevel=4 lightel=8 inplevel=3 numzones=5 end
6 0.001 500 6.6213 3 6.8521 10 7.0213 11 7.4812
bon
end
nit
end

```



```

xsd
jldr c3 #1 buckling correction, r=63.5 & ht=147 3/29/96
i2= -2, 14, 0, 0, 0, 0, 0, 0, 0, 1,
x5= 1-4, 1-4, 1, 0, 0, 0.71, 63.5, 147,
end
power=3.7386 burn=144.33 down=534.7 end
power=3.7386 burn=144.33 down=534.7 end
power=3.7386 burn=144.33 down=534.7 end
power=3.7386 burn=144.33 down=1430.0 end
h 16.4 o 265.0 cr 2.4
mn 0.15 fe 6.6 ni 2.4
zr 516.0 sn 8.7
,
' - - - - -
end

=sas2 parm='halt04,skipshipdata'
jldr bwr, assy a-20, rod e-2, #3 at 114.885 cm, 5.6022 gwd/mtu b5 7/97 4.3r
,
' - - - - -
,
mixtures of fuel-pin-unit-cell:
,
44group latticecell
uo2 1 den=10.13 1 840 92234 0.0153 92235 2.5966 92236 0.0161
92238 97.372 end
co-59 3 0 1-20 550 end
zr-94 1 0 1-20 840 end
nb-95 1 0 1-20 840 end
mo-95 1 0 1-20 840 end
tc-99 1 0 1-20 840 end
rh-103 1 0 1-20 840 end
rh-105 1 0 1-20 840 end
ru-106 1 0 1-20 840 end
sn-126 1 0 1-20 840 end
xe-131 1 0 1-20 840 end
cs-134 1 0 1-20 840 end
cs-135 1 0 1-20 840 end
cs-137 1 0 1-20 840 end
pr-143 1 0 1-20 840 end
nd-143 1 0 1-20 840 end
ce-144 1 0 1-20 840 end
nd-144 1 0 1-20 840 end
nd-145 1 0 1-20 840 end
nd-146 1 0 1-20 840 end
nd-147 1 0 1-20 840 end
pm-147 1 0 1-20 840 end
sm-147 1 0 1-20 840 end
nd-148 1 0 1-20 840 end
pm-148 1 0 1-20 840 end
sm-148 1 0 1-20 840 end
pm-149 1 0 1-20 840 end
sm-149 1 0 1-20 840 end
nd-150 1 0 1-20 840 end
sm-150 1 0 1-20 840 end
sm-151 1 0 1-20 840 end
eu-151 1 0 1-20 840 end
sm-152 1 0 1-20 840 end
eu-153 1 0 1-20 840 end
eu-154 1 0 1-20 840 end

```

```

gd-154 1 0 1-20 840 end
eu-155 1 0 1-20 840 end
gd-155 1 0 1-20 840 end
gd-157 1 0 1-20 840 end
gd-158 1 0 1-20 840 end
gd-160 1 0 1-20 840 end
' need the following to use endf/b5 library:
zirc2 2 1 620 end
'
h2o 3 den=0.5688 1 550 end
'
' -----
' mixtures of larger-unit-cell:
'
n 6 0 1-5 840 end
'
' need the following to use endf/b5 library:
zirc2 10 1 550 end
' ....above is zircalloy casing around assembly
h2o 11 den=0.77500 1 539 end
' ....above is channel moderator at higher density
end comp
'
' -----
' fuel-pin-cell geometry:
'
squarepitch 1.956 1.260 1 3 1.412 2 end
'
' -----
' assembly and cycle parameters:
'
' input-level=3 between geom line & powers corrects for buckling
npin/assm=36 fuelngth=2494.9 ncycles=4 nlib/cyc=1
printlevel=4 lightel=8 inplevel=3 numzones=5 end
6 0.001 500 6.6213 3 6.8521 10 7.0213 11 7.4812
bon
end
nit
end
xsd
jpdcr c3 #1 buckling correction, r=63.5 & ht=147 3/29/96
i2= -2, 14, 0, 0, 0, 0, 0, 0, 0, 1,
x5= 1-4, 1-4, 1, 0, 0, 0.71, 63.5, 147,
end
power=9.7041 burn=144.33 down=534.7 end
power=9.7041 burn=144.33 down=534.7 end
power=9.7041 burn=144.33 down=534.7 end
power=9.7041 burn=144.33 down=1430.0 end
h 16.4 o 265.0 cr 2.4
mn 0.15 fe 6.6 ni 2.4
zr 516.0 sn 8.7
'
' -----
end

=sas2 parm='halt04,skipshipdata'
jpdcr bwr, assy a-20, rod e-2, #10 at 31.785 cm, 5.3770 gwd/mtu b5 7/97 4.3r

```

```

'
' -----
'
'   mixtures of fuel-pin-unit-cell:
'
44group      latticecell
uo2  1 den=10.13 1 840 92234 0.0153 92235 2.5966 92236 0.0161
      92238 97.372  end
co-59  3 0 1-20 550  end
zr-94  1 0 1-20 840  end
nb-95  1 0 1-20 840  end
mo-95  1 0 1-20 840  end
tc-99  1 0 1-20 840  end
rh-103 1 0 1-20 840  end
rh-105 1 0 1-20 840  end
ru-106 1 0 1-20 840  end
sn-126 1 0 1-20 840  end
xe-131 1 0 1-20 840  end
cs-134 1 0 1-20 840  end
cs-135 1 0 1-20 840  end
cs-137 1 0 1-20 840  end
pr-143 1 0 1-20 840  end
nd-143 1 0 1-20 840  end
ce-144 1 0 1-20 840  end
nd-144 1 0 1-20 840  end
nd-145 1 0 1-20 840  end
nd-146 1 0 1-20 840  end
nd-147 1 0 1-20 840  end
pm-147 1 0 1-20 840  end
sm-147 1 0 1-20 840  end
nd-148 1 0 1-20 840  end
pm-148 1 0 1-20 840  end
sm-148 1 0 1-20 840  end
pm-149 1 0 1-20 840  end
sm-149 1 0 1-20 840  end
nd-150 1 0 1-20 840  end
sm-150 1 0 1-20 840  end
sm-151 1 0 1-20 840  end
eu-151 1 0 1-20 840  end
sm-152 1 0 1-20 840  end
eu-153 1 0 1-20 840  end
eu-154 1 0 1-20 840  end
gd-154 1 0 1-20 840  end
eu-155 1 0 1-20 840  end
gd-155 1 0 1-20 840  end
gd-157 1 0 1-20 840  end
gd-158 1 0 1-20 840  end
gd-160 1 0 1-20 840  end
'   need the following to use endf/b5 library:
zirc2  2 1 620  end
'
h2o  3 den=0.7534 1 550 end
'
' -----
'
'   mixtures of larger-unit-cell:
'
n      6 0 1-5 840  end
'
'   need the following to use endf/b5 library:
zirc2  10 1 550  end
'   ....above is zircalloy casing around assembly
h2o    11 den=0.77500 1 539 end
'   ....above s channel moderator at higher density

```

```

end comp
'
' -----
'
'      fuel-pin-cell geometry:
'
squarepitch  1.956  1.260  1 3  1.412  2  end
'
' -----
'
'      assembly and cycle parameters:
'
'      input-level=3 between geom line & powers corrects for buckling
npin/assm=36  fuelngth=2494.9  ncycles=4  nlib/cyc=1
printlevel=4  lightel=8  inplevel=3  numzones=5  end
6 0.001  500 6.6213  3 6.8521  10 7.0213  11 7.4812
bon
end
nit
end
xsd
jpdrc3 #1 buckling correction, r=63.5 & ht=147  3/29/96
i2= -2, 14, 0, 0, 0, 0, 0, 0, 0, 1,
x5= 1-4, 1-4, 1, 0, 0, 0.71, 63.5, 147,
end
power=9.3139  burn=144.33  down=534.7  end
power=9.3139  burn=144.33  down=534.7  end
power=9.3139  burn=144.33  down=534.7  end
power=9.3139  burn=144.33  down=1430.0  end
      h  16.4      o  265.0      cr  2.4
      mn 0.15     fe  6.6       ni  2.4
      zr 516.0    sn  8.7
'
' -----
end

```

APPENDIX E

MEASURED AND COMPUTED ISOTOPIC CONCENTRATIONS FOR COOPER BWR FUEL SAMPLES

cooper nuclear station bwr

measured and computed irradiated fuel composition

atm-105, fuel assembly CZ346, rod b3 at cut b, 18.96 gwd/mtu

run august 1997

..compares cases using 44GROUPNDF5 library..

nuclide, z & name	measured	44GROUPNDF5	%)diff
units: milligrams/gram uo2			
92 u234	1.700E-01	1.695E-01	(-0.3%)
92 u235	1.191E+01	1.175E+01	(-1.3%)
92 u236	2.630E+00	2.610E+00	(-0.7%)
92 u238	8.437E+02	8.431E+02	(-0.1%)
94 pu238	5.350E-02	5.297E-02	(-1.0%)
94 pu239	3.738E+00	3.973E+00	(6.3%)
94 pu240	1.220E+00	1.246E+00	(2.1%)
94 pu241	3.403E-01	3.985E-01	(17.1%)
94 pu242	9.892E-02	1.214E-01	(22.7%)

units: curies/gram uo2			
93 np237	1.110E-07	1.302E-07	(17.3%)
95 am241	5.180E-04	6.651E-04	(28.4%)
96 cm243		3.339E-06	
96 cm244		1.522E-04	
96 cm243..cm244	1.100E-04	1.555E-04	(41.4%)
34 se 79	2.770E-08	3.459E-08	(24.9%)
38 sr 90	3.210E-02	3.400E-02	(5.9%)
43 tc 99	6.260E-06	7.144E-06	(14.1%)
50 sn126	7.790E-08	2.385E-07	(206.1%)
55 cs135	3.740E-07	4.128E-07	(10.4%)
55 cs137	4.270E-02	4.425E-02	(3.6%)

cooper nuclear station bwr

measured and computed irradiated fuel composition

atm-105, fuel assembly CZ346, rod b3 at cut k, 33.07 gwd/mtu

run august 1997

..compares cases using 44GROUPNDF5 library..

nuclide, z & name	measured	44GROUPNDF5	%)diff
units: milligrams/gram uo2			
92 u234	1.350E-01	1.391E-01	(3.1%)
92 u235	5.340E+00	5.333E+00	(-0.1%)
92 u236	3.530E+00	3.473E+00	(-1.6%)
92 u238	8.346E+02	8.341E+02	(-0.1%)
94 pu238	1.743E-01	1.620E-01	(-7.0%)
94 pu239	3.579E+00	3.894E+00	(8.8%)
94 pu240	2.216E+00	2.083E+00	(-6.0%)
94 pu241	6.390E-01	6.869E-01	(7.5%)
94 pu242	4.407E-01	4.649E-01	(5.5%)

units: curies/gram uo2			
93 np237	2.540E-07	2.433E-07	(-4.2%)
95 am241	8.780E-04	1.056E-03	(20.3%)
96 cm243		1.706E-05	
96 cm244		1.695E-03	
96 cm243..cm244	1.450E-03	1.712E-03	(18.1%)
34 se 79	4.590E-08	5.881E-08	(28.1%)
38 sr 90	4.860E-02	5.354E-02	(10.2%)
43 tc 99	1.030E-05	1.180E-05	(14.6%)
50 sn126	1.520E-07	4.839E-07	(218.4%)
55 cs135	4.460E-07	4.847E-07	(8.7%)
55 cs137	7.480E-02	7.729E-02	(3.3%)

cooper nuclear station bwr

measured and computed irradiated fuel composition

atm-105, fuel assembly CZ346, rod b3 at cut t, 33.94 gwd/mtu

run august 1997

..compares cases using 44GROUPNDF5 library..

nuclide, z & name measured 44GROUPNDF5 %diff

units: milligrams/gram uo2

92	u234	1.440E-01	1.381E-01	(-4.1%)
92	u235	4.830E+00	4.703E+00	(-2.6%)
92	u236	3.630E+00	3.518E+00	(-3.1%)
92	u238	8.381E+02	8.342E+02	(-0.5%)
94	pu238	1.706E-01	1.590E-01	(-6.8%)
94	pu239	3.336E+00	3.594E+00	(7.7%)
94	pu240	2.190E+00	2.080E+00	(-5.0%)
94	pu241	6.201E-01	6.566E-01	(5.9%)
94	pu242	4.737E-01	4.963E-01	(4.8%)

units: curies/gram uo2

93	np237	2.460E-07	2.382E-07	(-3.2%)
95	am241	8.380E-04	9.963E-04	(18.9%)
96	cm243		1.683E-05	
96	cm244		1.716E-03	
96	cm243..cm244	1.500E-03	1.733E-03	(15.5%)
34	se 79	4.960E-08	6.037E-08	(21.7%)
38	sr 90	5.090E-02	5.510E-02	(8.2%)
43	tc 99	1.060E-05	1.213E-05	(14.5%)
50	sn126	1.600E-07	4.960E-07	(210.0%)
55	cs135	4.290E-07	4.664E-07	(8.7%)
55	cs137	7.700E-02	7.939E-02	(3.1%)

cooper nuclear station bwr

measured and computed irradiated fuel composition

atm-105, fuel assembly CZ346, rod c3 at cut b, 17.84 gwd/mtu

run august 1997

..compares cases using 44GROUPNDF5 library..

nuclide, z & name measured 44GROUPNDF5 %diff

units: milligrams/gram uo2

92	u234	1.740E-01	1.724E-01	(-0.9%)
92	u235	1.300E+01	1.236E+01	(-4.9%)
92	u236	2.480E+00	2.512E+00	(1.3%)
92	u238	8.545E+02	8.439E+02	(-1.2%)
94	pu238	5.210E-02	4.593E-02	(-11.9%)
94	pu239	4.056E+00	3.900E+00	(-3.9%)
94	pu240	1.184E+00	1.162E+00	(-1.9%)
94	pu241	3.415E-01	3.669E-01	(7.4%)
94	pu242	8.742E-02	1.036E-01	(18.5%)

units: curies/gram uo2

93	np237	1.090E-07	1.200E-07	(10.1%)
95	am241	5.230E-04	6.091E-04	(16.5%)
96	cm243		2.701E-06	
96	cm244		1.136E-04	
96	cm243..cm244	1.140E-04	1.163E-04	(2.0%)
34	se 79	2.700E-08	3.261E-08	(20.8%)
38	sr 90	2.920E-02	3.237E-02	(10.8%)
43	tc 99	6.170E-06	6.753E-06	(9.5%)
50	sn126	7.340E-08	2.203E-07	(200.2%)
55	cs135	3.830E-07	4.001E-07	(4.5%)
55	cs137	4.050E-02	4.170E-02	(3.0%)

cooper nuclear station bwr

measured and computed irradiated fuel composition

atm-105, fuel assembly CZ346, rod c3 at cut j, 29.23 gwd/mtu

run august 1997

..compares cases using 44GROUPNDF5 library..

nuclide, z & name measured 44GROUPNDF5 %diff

units: milligrams/gram uo2

92	u234	1.460E-01	1.459E-01	(-0.1%)
92	u235	7.760E+00	7.025E+00	(-9.5%)
92	u236	3.360E+00	3.297E+00	(-1.9%)
92	u238	8.490E+02	8.361E+02	(-1.5%)
94	pu238	1.460E-01	1.357E-01	(-7.0%)
94	pu239	4.526E+00	4.211E+00	(-6.9%)
94	pu240	2.164E+00	1.924E+00	(-11.1%)
94	pu241	6.649E-01	6.577E-01	(-1.1%)
94	pu242	3.247E-01	3.487E-01	(7.4%)

units: curies/gram uo2

93	np237	2.350E-07	2.219E-07	(-5.6%)
95	am241	9.460E-04	1.030E-03	(8.9%)
96	cm243		1.316E-05	
96	cm244		1.098E-03	
96	cm243..cm244	1.100E-03	1.111E-03	(1.0%)
34	se 79	4.260E-08	5.229E-08	(22.8%)
38	sr 90	4.380E-02	4.836E-02	(10.4%)
43	tc 99	9.860E-06	1.055E-05	(7.0%)
50	sn126	1.410E-07	4.164E-07	(195.3%)
55	cs135	5.230E-07	4.891E-07	(-6.5%)
55	cs137	7.250E-02	6.836E-02	(-5.7%)

cooper nuclear station bwr

measured and computed irradiated fuel composition

atm-105, fuel assembly CZ346, rod c3 at cut u, 31.04 gwd/mtu

run august 1997

..compares cases using 44GROUPNDF5 library..

nuclide, z & name measured 44GROUPNDF5 %diff

units: milligrams/gram uo2

92	u234	1.540E-01	1.446E-01	(-6.1%)
92	u235	6.280E+00	5.544E+00	(-11.7%)
92	u236	3.480E+00	3.409E+00	(-2.0%)
92	u238	8.455E+02	8.366E+02	(-1.1%)
94	pu238	1.389E-01	1.294E-01	(-6.9%)
94	pu239	3.668E+00	3.510E+00	(-4.3%)
94	pu240	2.082E+00	1.924E+00	(-7.6%)
94	pu241	6.139E-01	5.979E-01	(-2.6%)
94	pu242	3.823E-01	4.031E-01	(5.4%)

units: curies/gram uo2

93	np237	2.360E-07	2.105E-07	(-10.8%)
95	am241	8.690E-04	9.134E-04	(5.1%)
96	cm243		1.263E-05	
96	cm244		1.088E-03	
96	cm243..cm244	1.070E-03	1.100E-03	(2.8%)
34	se 79	4.500E-08	5.564E-08	(23.6%)
38	sr 90	4.820E-02	5.189E-02	(7.7%)
43	tc 99	1.000E-05	1.126E-05	(12.6%)
50	sn126	1.460E-07	4.394E-07	(200.9%)
55	cs135	4.310E-07	4.508E-07	(4.6%)
55	cs137	6.850E-02	7.276E-02	(6.2%)

APPENDIX F

MEASURED AND COMPUTED ISOTOPIC CONCENTRATIONS FOR GUNDREMMINGEN BWR FUEL SAMPLES

gundremmingen bwr

measured and computed irradiated fuel composition
fuel assembly b23, rod a1, 268 cm height, 27.400 gwd/mtu
run august 1997
..compares cases using 44GROUPNDF5 library..

nuclide, z & name	measured	44GROUPNDF5	%diff
units: milligrams/gram u			
92 u235	6.741E+00	6.424E+00	(-4.7%)
92 u236	3.294E+00	3.248E+00	(-1.4%)
92 u238	9.519E+02	9.528E+02	(0.1%)
94 pu238	1.080E-01	1.169E-01	(8.2%)
94 pu239	4.800E+00	4.733E+00	(-1.4%)
94 pu240	2.168E+00	2.184E+00	(0.7%)
94 pu241	9.540E-01	8.596E-01	(-9.9%)
94 pu242	4.494E-01	3.941E-01	(-12.3%)
96 cm244	1.977E-02	1.811E-02	(-8.4%)
60 nd148	3.088E-01	3.024E-01	(-2.1%)
units: curies/gram u			
55 cs134	3.222E-02	3.716E-02	(15.3%)
55 cs137	7.031E-02	8.244E-02	(17.3%)
63 eu154	3.708E-03	3.696E-03	(-0.3%)

gundremmingen bwr

measured and computed irradiated fuel composition
fuel assembly b23, rod a1, 44 cm height, 25.730 gwd/mtu
run august 1997
..compares cases using 44GROUPNDF5 library..

nuclide, z & name	measured	44GROUPNDF5	%diff
units: milligrams/gram u			
92 u235	6.307E+00	6.053E+00	(-4.0%)
92 u236	3.280E+00	3.198E+00	(-2.5%)
92 u238	9.561E+02	9.564E+02	(0.0%)
94 pu238	6.800E-02	8.123E-02	(19.5%)
94 pu239	3.736E+00	3.791E+00	(1.5%)
94 pu240	1.815E+00	1.940E+00	(6.9%)
94 pu241	7.052E-01	6.847E-01	(-2.9%)
94 pu242	3.305E-01	3.500E-01	(5.9%)
96 cm244	8.868E-03	9.235E-03	(4.1%)
60 nd148	2.899E-01	2.842E-01	(-2.0%)
units: curies/gram u			
55 cs134	3.461E-02	3.035E-02	(-12.3%)
55 cs137	8.942E-02	7.772E-02	(-13.1%)
63 eu154	3.707E-03	2.680E-03	(-27.7%)

gundremmingen bwr

measured and computed irradiated fuel composition
fuel assembly b23, rod b3, 268 cm height, 21.240 gwd/mtu
run august 1997

..compares cases using 44GROUPNDF5 library..

nuclide, z & name	measured	44GROUPNDF5	%diff
units: milligrams/gram u			
92 u235	9.823E+00	9.072E+00	(-7.6%)
92 u236	2.952E+00	2.882E+00	(-2.4%)
92 u238	9.559E+02	9.580E+02	(0.2%)
94 pu238	8.300E-02	6.785E-02	(-18.3%)
94 pu239	5.372E+00	4.536E+00	(-15.6%)
94 pu240	1.855E+00	1.709E+00	(-7.9%)
94 pu241	7.855E-01	6.597E-01	(-16.0%)
94 pu242	2.232E-01	2.183E-01	(-2.2%)
96 cm244	8.622E-03	5.760E-03	(-33.2%)
60 nd148	2.394E-01	2.350E-01	(-1.8%)
units: curies/gram u			
55 cs134	2.645E-02	2.361E-02	(-10.7%)
55 cs137	6.485E-02	6.408E-02	(-1.2%)
63 eu154	3.246E-03	2.367E-03	(-27.1%)

gundremmingen bwr

measured and computed irradiated fuel composition
fuel assembly b23, rod e3, 268 cm height, 23.510 gwd/mtu
run august 1997

..compares cases using 44GROUPNDF5 library..

nuclide, z & name	measured	44GROUPNDF5	%diff
units: milligrams/gram u			
92 u235	8.618E+00	8.013E+00	(-7.0%)
92 u236	3.133E+00	3.034E+00	(-3.1%)
92 u238	9.547E+02	9.561E+02	(0.2%)
94 pu238	8.400E-02	8.430E-02	(0.4%)
94 pu239	4.820E+00	4.628E+00	(-4.0%)
94 pu240	1.845E+00	1.893E+00	(2.6%)
94 pu241	7.276E-01	7.177E-01	(-1.4%)
94 pu242	2.461E-01	2.779E-01	(12.9%)
96 cm244	9.176E-03	8.955E-03	(-2.4%)
60 nd148	2.717E-01	2.599E-01	(-4.4%)
units: curies/gram u			
55 cs134	2.481E-02	2.319E-02	(-6.5%)
55 cs137	6.640E-02	6.989E-02	(5.3%)
63 eu154	3.035E-03	2.708E-03	(-10.8%)

gundremmingen bwr

measured and computed irradiated fuel composition
fuel assembly c16, rod a1, 268 cm height, 20.300 gwd/mtu
run august 1997

..compares cases using 44GROUPNDF5 library..

nuclide, z & name	measured	44GROUPNDF5	%diff
units: milligrams/gram u			
92 u235	9.803E+00	9.558E+00	(-2.5%)
92 u236	2.901E+00	2.777E+00	(-4.3%)
92 u238	9.591E+02	9.591E+02	(0.0%)
94 pu238	4.800E-02	5.216E-02	(8.7%)
94 pu239	4.418E+00	4.273E+00	(-3.3%)
94 pu240	1.533E+00	1.551E+00	(1.2%)
94 pu241	6.501E-01	5.886E-01	(-9.5%)
94 pu242	2.013E-01	1.868E-01	(-7.2%)
96 cm244	4.480E-03	3.728E-03	(-16.8%)
60 nd148	2.217E-01	2.201E-01	(-0.7%)

units: curies/gram u

55 cs134	2.370E-02	1.816E-02	(-23.4%)
55 cs137	6.532E-02	5.979E-02	(-8.5%)
63 eu154	2.175E-03	1.906E-03	(-12.4%)

gundremmingen bwr

measured and computed irradiated fuel composition
fuel assembly c16, rod a1, 44 cm height, 19.850 gwd/mtu
run august 1997

..compares cases using 44GROUPNDF5 library..

nuclide, z & name	measured	44GROUPNDF5	%diff
units: milligrams/gram u			
92 u235	8.588E+00	8.602E+00	(0.2%)
92 u236	3.077E+00	2.838E+00	(-7.8%)
92 u238	9.607E+02	9.602E+02	(0.0%)
94 pu238	3.600E-02	4.420E-02	(22.8%)
94 pu239	3.635E+00	3.671E+00	(1.0%)
94 pu240	1.472E+00	1.517E+00	(3.1%)
94 pu241	5.205E-01	5.241E-01	(0.7%)
94 pu242	1.820E-01	1.918E-01	(5.4%)
96 cm244	2.614E-03	2.758E-03	(5.5%)
60 nd148	2.268E-01	2.250E-01	(-0.8%)

units: curies/gram u

55 cs134	1.884E-02	1.739E-02	(-7.7%)
55 cs137	6.196E-02	6.132E-02	(-1.0%)
63 eu154	1.777E-03	1.668E-03	(-6.1%)

gundremmingen bwr

measured and computed irradiated fuel composition
fuel assembly c16, rod b3, 268 cm height, 14.390 gwd/mtu
run august 1997

..compares cases using 44GROUPNDF5 library..

nuclide, z & name	measured	44GROUPNDF5	%diff
units: milligrams/gram u			
92 u235	1.311E+01	1.277E+01	(-2.6%)
92 u236	2.452E+00	2.280E+00	(-7.0%)
92 u238	9.621E+02	9.634E+02	(0.1%)
94 pu238	3.300E-02	2.508E-02	(-24.0%)
94 pu239	4.695E+00	3.885E+00	(-17.3%)
94 pu240	1.170E+00	1.078E+00	(-7.8%)
94 pu241	4.807E-01	3.862E-01	(-19.7%)
94 pu242	8.897E-02	8.060E-02	(-9.4%)
96 cm244	1.569E-03	7.937E-04	(-49.4%)
60 nd148	1.632E-01	1.599E-01	(-2.1%)
units: curies/gram u			
55 cs134	1.438E-02	1.141E-02	(-20.6%)
55 cs137	4.621E-02	4.382E-02	(-5.2%)
63 eu154	1.568E-03	1.062E-03	(-32.3%)

gundremmingen bwr

measured and computed irradiated fuel composition
fuel assembly c16, rod e5, 268 cm height, 17.490 gwd/mtu
run august 1997

..compares cases using 44GROUPNDF5 library..

nuclide, z & name	measured	44GROUPNDF5	%diff
units: milligrams/gram u			
92 u235	1.044E+01	1.086E+01	(4.0%)
92 u236	2.740E+00	2.580E+00	(-5.9%)
92 u238	9.612E+02	9.610E+02	(0.0%)
94 pu238	4.100E-02	3.934E-02	(-4.1%)
94 pu239	4.157E+00	4.138E+00	(-0.5%)
94 pu240	1.442E+00	1.352E+00	(-6.2%)
94 pu241	5.328E-01	5.153E-01	(-3.3%)
94 pu242	1.500E-01	1.353E-01	(-9.8%)
96 cm244	2.794E-03	2.081E-03	(-25.5%)
60 nd148	1.989E-01	1.940E-01	(-2.4%)
units: curies/gram u			
55 cs134	1.697E-02	1.766E-02	(4.0%)
55 cs137	5.241E-02	5.348E-02	(2.0%)
63 eu154	1.772E-03	1.578E-03	(-11.0%)

APPENDIX G

MEASURED AND COMPUTED ISOTOPIC CONCENTRATIONS FOR JPDR BWR FUEL SAMPLES

japan power demonstration reactor bwr

measured and computed irradiated fuel composition

fuel assembly a-14, mid-rod, node 2, 3.303 gwd/mtu

run august 1997

..compares cases using 44GROUPNDF5 library..

nuclide, z & name	measured	44GROUPNDF5	%diff
units: milligrams/gram u			
92 u234	1.468E-01	1.454E-01	(-0.9%)
92 u235	2.252E+01	2.228E+01	(-1.1%)
92 u236	7.973E-01	7.960E-01	(-0.2%)
92 u238	9.714E+02	9.715E+02	(0.0%)
94 pu238	8.437E-04	6.485E-04	(-23.1%)
94 pu239	1.531E+00	1.452E+00	(-5.1%)
94 pu240	1.136E-01	1.117E-01	(-1.7%)
94 pu241	1.570E-02	1.400E-02	(-10.8%)
94 pu242	5.719E-04	5.396E-04	(-5.6%)
95 am241	3.356E-03	3.194E-03	(-4.8%)
96 cm242	2.620E-07	3.175E-07	(21.2%)
96 cm244	2.200E-07	1.536E-07	(-30.2%)
55 cs137	1.190E-01	1.114E-01	(-6.4%)
60 nd143	1.168E-01	1.183E-01	(1.3%)
60 nd144	1.152E-01	1.154E-01	(0.2%)
60 nd145	8.086E-02	8.178E-02	(1.1%)
60 nd146	6.447E-02	6.501E-02	(0.8%)
60 nd148	3.679E-02	3.709E-02	(0.8%)
60 nd150	1.577E-02	1.567E-02	(-0.6%)

japan power demonstration reactor bwr

measured and computed irradiated fuel composition

fuel assembly a-14, mid-rod, node 9, 4.035 gwd/mtu

run august 1997

..compares cases using 44GROUPNDF5 library..

nuclide, z & name	measured	44GROUPNDF5	%diff
units: milligrams/gram u			
92 u234	1.417E-01	1.443E-01	(1.8%)
92 u235	2.154E+01	2.148E+01	(-0.3%)
92 u236	9.119E-01	9.190E-01	(0.8%)
92 u238	9.713E+02	9.712E+02	(0.0%)
94 pu238	1.088E-03	8.747E-04	(-19.6%)
94 pu239	1.647E+00	1.573E+00	(-4.5%)
94 pu240	1.510E-01	1.468E-01	(-2.8%)
94 pu241	2.145E-02	1.982E-02	(-7.6%)
94 pu242	1.014E-03	9.577E-04	(-5.6%)
95 am241	4.931E-03	4.522E-03	(-8.3%)
96 cm242	3.990E-07	5.367E-07	(34.5%)
96 cm244	4.350E-07	3.332E-07	(-23.4%)
55 cs137	1.455E-01	1.363E-01	(-6.4%)
60 nd143	1.422E-01	1.434E-01	(0.8%)
60 nd144	1.431E-01	1.422E-01	(-0.6%)
60 nd145	9.901E-02	9.971E-02	(0.7%)
60 nd146	7.900E-02	7.947E-02	(0.6%)
60 nd148	4.493E-02	4.526E-02	(0.7%)
60 nd150	1.924E-02	1.910E-02	(-0.7%)

japan power demonstration reactor bwr

measured and computed irradiated fuel composition

fuel assembly a-18, mid-rod, node 2, 2.712 gwd/mtu

run august 1997

..compares cases using 44GROUPNDF5 library..

nuclide, z & name	measured	44GROUPNDF5	%diff
units: milligrams/gram u			
92 u234	1.469E-01	1.466E-01	(-0.2%)
92 u235	2.296E+01	2.291E+01	(-0.2%)
92 u236	6.904E-01	6.913E-01	(0.1%)
92 u238	9.720E+02	9.718E+02	(0.0%)
94 pu238	3.009E-04	4.373E-04	(45.3%)
94 pu239	1.229E+00	1.269E+00	(3.2%)
94 pu240	7.626E-02	8.138E-02	(6.7%)
94 pu241	8.451E-03	8.844E-03	(4.7%)
94 pu242	1.929E-04	2.756E-04	(42.9%)
95 am241	1.816E-03	2.014E-03	(10.9%)
96 cm242	1.130E-07	1.653E-07	(46.3%)
96 cm244	5.810E-08	5.589E-08	(-3.8%)
55 cs137	9.370E-02	9.137E-02	(-2.5%)
60 nd143	9.618E-02	9.795E-02	(1.8%)
60 nd144	9.388E-02	9.436E-02	(0.5%)
60 nd145	6.633E-02	6.740E-02	(1.6%)
60 nd146	5.263E-02	5.336E-02	(1.4%)
60 nd148	3.001E-02	3.047E-02	(1.5%)
60 nd150	1.284E-02	1.285E-02	(0.0%)

japan power demonstration reactor bwr

measured and computed irradiated fuel composition

fuel assembly a-18, mid-rod, node 6, 4.251 gwd/mtu

run august 1997

..compares cases using 44GROUPNDF5 library..

nuclide, z & name	measured	44GROUPNDF5	%diff
units: milligrams/gram u			
92 u234	1.456E-01	1.435E-01	(-1.4%)
92 u235	2.153E+01	2.129E+01	(-1.1%)
92 u236	9.264E-01	9.583E-01	(3.4%)
92 u238	9.710E+02	9.710E+02	(0.0%)
94 pu238	1.240E-03	1.088E-03	(-12.2%)
94 pu239	1.701E+00	1.708E+00	(0.4%)
94 pu240	1.599E-01	1.659E-01	(3.7%)
94 pu241	2.392E-02	2.469E-02	(3.2%)
94 pu242	1.203E-03	1.256E-03	(4.4%)
95 am241	5.942E-03	5.644E-03	(-5.0%)
96 cm242	5.350E-07	7.198E-07	(34.5%)
96 cm244	6.340E-07	5.519E-07	(-13.0%)
55 cs137	1.481E-01	1.434E-01	(-3.1%)
60 nd143	1.493E-01	1.502E-01	(0.6%)
60 nd144	1.504E-01	1.495E-01	(-0.6%)
60 nd145	1.042E-01	1.046E-01	(0.4%)
60 nd146	8.340E-02	8.369E-02	(0.4%)
60 nd148	4.733E-02	4.768E-02	(0.7%)
60 nd150	2.025E-02	2.023E-02	(-0.1%)

japan power demonstration reactor bwr

measured and computed irradiated fuel composition

fuel assembly a-20, rod a1, node 3, 7.0098 gwd/mtu

run august 1997

..compares cases using 44GROUPNDF5 library..

nuclide, z & name	measured	44GROUPNDF5	%diff
units: milligrams/gram u			
92 u234	1.353E-01	1.376E-01	(1.7%)
92 u235	1.888E+01	1.867E+01	(-1.1%)
92 u236	1.390E+00	1.400E+00	(0.7%)
92 u238	9.694E+02	9.693E+02	(0.0%)
94 pu238	3.564E-03	3.705E-03	(4.0%)
94 pu239	2.360E+00	2.426E+00	(2.8%)
94 pu240	3.518E-01	3.678E-01	(4.5%)
94 pu241	7.508E-02	7.667E-02	(2.1%)
94 pu242	6.739E-03	7.151E-03	(6.1%)
93 np237	3.943E-02	4.398E-02	(11.5%)
95 am241	1.825E-02	2.163E-02	(18.5%)
95 am242	7.470E-05	8.070E-05	(8.0%)
96 cm242	8.960E-07	1.208E-06	(34.8%)
96 cm244	7.850E-06	8.980E-06	(14.4%)
44 ru106	5.793E-04	8.671E-04	(49.7%)
55 cs134	1.018E-03	1.124E-03	(10.4%)
55 cs137	2.239E-01	2.320E-01	(3.6%)
58 ce144	9.643E-04	1.839E-03	(90.7%)
60 nd143	2.366E-01	2.370E-01	(0.1%)
60 nd144	2.552E-01	2.521E-01	(-1.2%)
60 nd145	1.686E-01	1.689E-01	(0.2%)
60 nd146	1.386E-01	1.382E-01	(-0.3%)
60 nd148	7.854E-02	7.843E-02	(-0.1%)
60 nd150	3.371E-02	3.395E-02	(0.7%)
63 eu154	6.523E-04	6.916E-04	(6.0%)
63 eu155	6.358E-04	3.663E-04	(-42.4%)

japan power demonstration reactor bwr

measured and computed irradiated fuel composition

fuel assembly a-20, rod a3, node 10, 6.1464 gwd/mtu

run august 1997

..compares cases using 44GROUPNDF5 library..

nuclide, z & name	measured	44GROUPNDF5	%diff
units: milligrams/gram u			
92 u234	1.433E-01	1.399E-01	(-2.4%)
92 u235	1.892E+01	1.940E+01	(2.5%)
92 u236	1.211E+00	1.265E+00	(4.5%)
92 u238	9.709E+02	9.700E+02	(-0.1%)
94 pu238	2.401E-03	2.410E-03	(0.4%)
94 pu239	2.016E+00	2.122E+00	(5.3%)
94 pu240	2.722E-01	2.907E-01	(6.8%)
94 pu241	4.812E-02	5.231E-02	(8.7%)
94 pu242	3.888E-03	4.231E-03	(8.8%)
93 np237	3.135E-02	3.421E-02	(9.1%)
95 am241	1.311E-02	1.471E-02	(12.2%)
95 am242	4.700E-05	4.969E-05	(5.7%)
96 cm242	5.640E-07	7.052E-07	(25.0%)
96 cm244	2.990E-06	3.478E-06	(16.3%)
44 ru106	4.296E-04	6.957E-04	(61.9%)
55 cs134	6.956E-04	8.245E-04	(18.5%)
55 cs137	1.941E-01	2.035E-01	(4.9%)
58 ce144	8.134E-04	1.632E-03	(100.6%)
60 nd143	2.114E-01	2.111E-01	(-0.1%)
60 nd144	2.239E-01	2.211E-01	(-1.3%)
60 nd145	1.498E-01	1.495E-01	(-0.2%)
60 nd146	1.213E-01	1.212E-01	(-0.1%)
60 nd148	6.885E-02	6.882E-02	(0.0%)
60 nd150	2.926E-02	2.947E-02	(0.7%)
63 eu154	4.696E-04	5.018E-04	(6.9%)
63 eu155	5.326E-04	3.231E-04	(-39.3%)

japan power demonstration reactor bwr

measured and computed irradiated fuel composition

fuel assembly a-20, rod a6, node 3, 6.9535 gwd/mtu

run august 1997

..compares cases using 44GROUPNDF5 library..

nuclide, z & name measured 44GROUPNDF5 %diff

units: milligrams/gram u

92	u234	1.343E-01	1.378E-01	(2.6%)
92	u235	1.875E+01	1.872E+01	(-0.2%)
92	u236	1.375E+00	1.391E+00	(1.2%)
92	u238	9.695E+02	9.693E+02	(0.0%)
94	pu238	3.875E-03	3.631E-03	(-6.3%)
94	pu239	2.432E+00	2.413E+00	(-0.8%)
94	pu240	3.592E-01	3.633E-01	(1.1%)
94	pu241	8.111E-02	7.532E-02	(-7.1%)
94	pu242	7.181E-03	6.960E-03	(-3.1%)
93	np237	4.141E-02	4.349E-02	(5.0%)
95	am241	2.114E-02	2.125E-02	(0.5%)
95	am242	1.003E-04	7.896E-05	(-21.3%)
96	cm242	1.090E-06	1.177E-06	(8.0%)
96	cm244	9.950E-06	8.586E-06	(-13.7%)
44	ru106	6.160E-04	8.569E-04	(39.1%)
55	cs134	1.081E-03	1.106E-03	(2.3%)
55	cs137	2.242E-01	2.301E-01	(2.6%)
58	ce144	1.021E-03	1.825E-03	(78.8%)
60	nd143	2.346E-01	2.353E-01	(0.3%)
60	nd144	2.521E-01	2.500E-01	(-0.8%)
60	nd145	1.672E-01	1.676E-01	(0.3%)
60	nd146	1.367E-01	1.371E-01	(0.3%)
60	nd148	7.789E-02	7.781E-02	(-0.1%)
60	nd150	3.316E-02	3.366E-02	(1.5%)
63	eu154	6.901E-04	6.802E-04	(-1.4%)
63	eu155	6.536E-04	3.635E-04	(-44.4%)

japan power demonstration reactor bwr

measured and computed irradiated fuel composition

fuel assembly a-20, rod a6, node 9, 6.5125 gwd/mtu

run august 1997

..compares cases using 44GROUPNDF5 library..

nuclide, z & name measured 44GROUPNDF5 %diff

units: milligrams/gram u

92	u234	1.364E-01	1.391E-01	(2.0%)
92	u235	1.909E+01	1.906E+01	(-0.2%)
92	u236	1.314E+00	1.322E+00	(0.6%)
92	u238	9.701E+02	9.698E+02	(0.0%)
94	pu238	2.969E-03	2.798E-03	(-5.8%)
94	pu239	2.173E+00	2.209E+00	(1.7%)
94	pu240	3.086E-01	3.187E-01	(3.3%)
94	pu241	5.974E-02	5.994E-02	(0.3%)
94	pu242	5.187E-03	5.182E-03	(-0.1%)
93	np237	3.527E-02	3.717E-02	(5.4%)
95	am241	1.609E-02	1.687E-02	(4.8%)
95	am242	6.960E-05	5.882E-05	(-15.5%)
96	cm242	7.570E-07	8.587E-07	(13.4%)
96	cm244	5.240E-06	4.863E-06	(-7.2%)
44	ru106	4.830E-04	7.576E-04	(56.9%)
55	cs134	8.299E-04	9.281E-04	(11.8%)
55	cs137	2.072E-01	2.157E-01	(4.1%)
58	ce144	8.651E-04	1.723E-03	(99.2%)
60	nd143	2.237E-01	2.223E-01	(-0.6%)
60	nd144	2.387E-01	2.346E-01	(-1.7%)
60	nd145	1.586E-01	1.580E-01	(-0.4%)
60	nd146	1.288E-01	1.284E-01	(-0.3%)
60	nd148	7.298E-02	7.289E-02	(-0.1%)
60	nd150	3.123E-02	3.130E-02	(0.2%)
63	eu154	5.402E-04	5.657E-04	(4.7%)
63	eu155	6.037E-04	3.402E-04	(-43.6%)

japan power demonstration reactor bwr

measured and computed irradiated fuel composition

fuel assembly a-20, rod c3, node 1, 2.6463 gwd/mtu

run august 1997

..compares cases using 44GROUPNDF5 library..

nuclide, z & name	measured	44GROUPNDF5	%diff
units: milligrams/gram u			
92 u234	1.459E-01	1.467E-01	(0.5%)
92 u235	2.318E+01	2.300E+01	(-0.8%)
92 u236	6.905E-01	6.807E-01	(-1.4%)
92 u238	9.718E+02	9.718E+02	(0.0%)
94 pu238	5.236E-04	4.355E-04	(-16.8%)
94 pu239	1.261E+00	1.276E+00	(1.2%)
94 pu240	7.798E-02	7.981E-02	(2.4%)
94 pu241	8.853E-03	8.404E-03	(-5.1%)
94 pu242	2.730E-04	2.652E-04	(-2.9%)
93 np237	1.430E-02	1.378E-02	(-3.6%)
95 am241	2.242E-03	2.351E-03	(4.9%)
95 am242	5.300E-06	4.893E-06	(-7.7%)
96 cm242	4.780E-08	5.169E-08	(8.1%)
96 cm244	7.710E-08	5.310E-08	(-31.1%)
44 ru106	1.674E-04	2.337E-04	(39.6%)
55 cs134	1.624E-04	1.753E-04	(7.9%)
55 cs137	8.287E-02	8.735E-02	(5.4%)
58 ce144	3.989E-04	7.196E-04	(80.4%)
60 nd143	9.515E-02	9.554E-02	(0.4%)
60 nd144	9.270E-02	9.271E-02	(0.0%)
60 nd145	6.547E-02	6.572E-02	(0.4%)
60 nd146	5.190E-02	5.206E-02	(0.3%)
60 nd148	2.960E-02	2.974E-02	(0.5%)
60 nd150	1.260E-02	1.256E-02	(-0.3%)
63 eu154	1.045E-04	1.061E-04	(1.5%)

japan power demonstration reactor bwr

measured and computed irradiated fuel composition

fuel assembly a-20, rod c3, node 3, 5.0861 gwd/mtu

run august 1997

..compares cases using 44GROUPNDF5 library..

nuclide, z & name	measured	44GROUPNDF5	%diff
units: milligrams/gram u			
92 u234	1.366E-01	1.413E-01	(3.4%)
92 u235	2.069E+01	2.053E+01	(-0.8%)
92 u236	1.097E+00	1.101E+00	(0.4%)
92 u238	9.702E+02	9.703E+02	(0.0%)
94 pu238	2.550E-03	1.903E-03	(-25.4%)
94 pu239	2.240E+00	2.074E+00	(-7.4%)
94 pu240	2.404E-01	2.325E-01	(-3.3%)
94 pu241	4.974E-02	4.114E-02	(-17.3%)
94 pu242	3.081E-03	2.633E-03	(-14.5%)
93 np237	3.482E-02	3.092E-02	(-11.2%)
95 am241	1.269E-02	1.159E-02	(-8.6%)
95 am242	2.000E-05	3.762E-05	(88.1%)
96 cm242	5.090E-07	4.795E-07	(-5.8%)
96 cm244	3.420E-06	1.948E-06	(-43.0%)
44 ru106	4.119E-04	5.666E-04	(37.6%)
55 cs134	6.386E-04	6.273E-04	(-1.8%)
55 cs137	1.601E-01	1.681E-01	(5.0%)
58 ce144	7.036E-04	1.351E-03	(92.0%)
60 nd143	1.762E-01	1.768E-01	(0.3%)
60 nd144	1.801E-01	1.802E-01	(0.1%)
60 nd145	1.233E-01	1.239E-01	(0.5%)
60 nd146	1.003E-01	1.001E-01	(-0.2%)
60 nd148	5.696E-02	5.701E-02	(0.1%)
60 nd150	2.489E-02	2.450E-02	(-1.6%)
63 eu154	4.353E-04	3.844E-04	(-11.7%)

japan power demonstration reactor bwr

measured and computed irradiated fuel composition

fuel assembly a-20, rod c3, node 5, 6.0808 gwd/mtu

run august 1997

..compares cases using 44GROUPNDF5 library..

nuclide, z & name	measured	44GROUPNDF5	%diff
units: milligrams/gram u			
92 u234	1.335E-01	1.394E-01	(4.4%)
92 u235	1.988E+01	1.955E+01	(-1.7%)
92 u236	1.266E+00	1.258E+00	(-0.6%)
92 u238	9.695E+02	9.698E+02	(0.0%)
94 pu238	3.710E-03	2.737E-03	(-26.2%)
94 pu239	2.472E+00	2.267E+00	(-8.3%)
94 pu240	3.143E-01	3.004E-01	(-4.4%)
94 pu241	7.112E-02	5.833E-02	(-18.0%)
94 pu242	5.311E-03	4.595E-03	(-13.5%)
93 np237	4.105E-02	3.745E-02	(-8.8%)
95 am241	1.829E-02	1.645E-02	(-10.1%)
95 am242	6.400E-05	5.793E-05	(-9.5%)
96 cm242	8.800E-07	8.025E-07	(-8.8%)
96 cm244	7.260E-06	4.533E-06	(-37.6%)
44 ru106	5.135E-04	7.160E-04	(39.4%)
55 cs134	8.872E-04	8.659E-04	(-2.4%)
55 cs137	1.924E-01	2.011E-01	(4.5%)
58 ce144	8.478E-04	1.605E-03	(89.3%)
60 nd143	2.069E-01	2.084E-01	(0.7%)
60 nd144	2.164E-01	2.171E-01	(0.3%)
60 nd145	1.466E-01	1.473E-01	(0.5%)
60 nd146	1.200E-01	1.198E-01	(-0.2%)
60 nd148	6.814E-02	6.809E-02	(-0.1%)
60 nd150	2.980E-02	2.936E-02	(-1.5%)
63 eu154	6.120E-04	5.318E-04	(-13.1%)

japan power demonstration reactor bwr

measured and computed irradiated fuel composition

fuel assembly a-20, rod c3, node 8, 6.0433 gwd/mtu

run august 1997

..compares cases using 44GROUPNDF5 library..

nuclide, z & name	measured	44GROUPNDF5	%diff
units: milligrams/gram u			
92 u234	1.442E-01	1.400E-01	(-2.9%)
92 u235	1.961E+01	1.952E+01	(-0.5%)
92 u236	1.260E+00	1.250E+00	(-0.8%)
92 u238	9.699E+02	9.700E+02	(0.0%)
94 pu238	3.290E-03	2.393E-03	(-27.3%)
94 pu239	2.353E+00	2.133E+00	(-9.3%)
94 pu240	3.038E-01	2.863E-01	(-5.8%)
94 pu241	6.493E-02	5.190E-02	(-20.1%)
94 pu242	4.976E-03	4.104E-03	(-17.5%)
93 np237	3.798E-02	3.423E-02	(-9.9%)
95 am241	1.642E-02	1.460E-02	(-11.1%)
95 am242	7.830E-05	4.941E-05	(-36.9%)
96 cm242	7.610E-07	6.925E-07	(-9.0%)
96 cm244	5.390E-06	3.410E-06	(-36.7%)
44 ru106	4.761E-04	6.858E-04	(44.0%)
55 cs134	7.835E-04	8.099E-04	(3.4%)
55 cs137	1.881E-01	2.001E-01	(6.4%)
58 ce144	7.976E-04	1.603E-03	(101.0%)
60 nd143	2.071E-01	2.078E-01	(0.3%)
60 nd144	2.171E-01	2.169E-01	(-0.1%)
60 nd145	1.466E-01	1.470E-01	(0.3%)
60 nd146	1.195E-01	1.191E-01	(-0.3%)
60 nd148	6.771E-02	6.767E-02	(-0.1%)
60 nd150	2.946E-02	2.901E-02	(-1.5%)
63 eu154	5.337E-04	4.936E-04	(-7.5%)

```

japan power demonstration reactor bwr

measured and computed irradiated fuel composition
fuel assembly a-20, rod c3, node 10, 5.058 gwd/mtu
run august 1997

..compares cases using 44GROUPNDF5 library..
nuclide, z & name      measured  44GROUPNDF5  %diff
units: milligrams/gram u
92  u234      1.454E-01  1.421E-01 ( -2.3%)
92  u235      2.055E+01  2.046E+01 ( -0.4%)
92  u236      1.094E+00  1.091E+00 ( -0.3%)
92  u238      9.707E+02  9.706E+02 (  0.0%)
94  pu238      1.894E-03  1.503E-03 (-20.6%)
94  pu239      1.951E+00  1.862E+00 ( -4.5%)
94  pu240      2.176E-01  2.135E-01 ( -1.9%)
94  pu241      3.864E-02  3.332E-02 (-13.8%)
94  pu242      2.441E-03  2.157E-03 (-11.6%)
93  np237      2.746E-02  2.639E-02 ( -3.9%)
95  am241      1.013E-02  9.354E-03 ( -7.7%)
95  am242      2.470E-05  2.836E-05 ( 14.8%)
96  cm242      3.880E-07  3.688E-07 ( -5.0%)
96  cm244      1.640E-06  1.179E-06 (-28.1%)
44  ru106      3.376E-04  5.275E-04 ( 56.2%)
55  cs134      5.141E-04  5.601E-04 (  8.9%)
55  cs137      1.572E-01  1.675E-01 (  6.5%)
58  ce144      6.313E-04  1.355E-03 (114.7%)
60  nd143      1.760E-01  1.768E-01 (  0.4%)
60  nd144      1.810E-01  1.808E-01 ( -0.1%)
60  nd145      1.237E-01  1.240E-01 (  0.2%)
60  nd146      9.963E-02  9.965E-02 (  0.0%)
60  nd148      5.672E-02  5.668E-02 ( -0.1%)
60  nd150      2.426E-02  2.410E-02 ( -0.6%)
63  eu154      3.527E-04  3.398E-04 ( -3.7%)

```

```

japan power demonstration reactor bwr

measured and computed irradiated fuel composition
fuel assembly a-20, rod c3, node 12, 2.158 gwd/mtu
run august 1997

..compares cases using 44GROUPNDF5 library..
nuclide, z & name      measured  44GROUPNDF5  %diff
units: milligrams/gram u
92  u234      1.510E-01  1.483E-01 ( -1.8%)
92  u235      2.354E+01  2.347E+01 ( -0.3%)
92  u236      5.843E-01  5.833E-01 ( -0.2%)
92  u238      9.724E+02  9.723E+02 (  0.0%)
94  pu238      2.511E-04  2.017E-04 (-19.7%)
94  pu239      9.554E-01  9.310E-01 ( -2.6%)
94  pu240      4.913E-02  4.862E-02 ( -1.0%)
94  pu241      3.955E-03  3.535E-03 (-10.6%)
94  pu242      1.021E-04  9.129E-05 (-10.6%)
93  np237      9.613E-03  8.677E-03 ( -9.7%)
95  am241      1.023E-03  9.845E-04 ( -3.8%)
95  am242      2.590E-06  1.618E-06 (-37.5%)
96  cm242      1.600E-08  1.666E-08 (  4.1%)
96  cm244      1.920E-08  8.089E-09 (-57.9%)
44  ru106      1.089E-04  1.643E-04 ( 50.9%)
55  cs134      9.330E-05  1.007E-04 (  8.0%)
55  cs137      6.825E-02  7.144E-02 (  4.7%)
58  ce144      2.862E-04  5.956E-04 (108.1%)
60  nd143      7.882E-02  7.913E-02 (  0.4%)
60  nd144      7.622E-02  7.613E-02 ( -0.1%)
60  nd145      5.406E-02  5.415E-02 (  0.2%)
60  nd146      4.224E-02  4.251E-02 (  0.6%)
60  nd148      2.419E-02  2.426E-02 (  0.3%)
60  nd150      1.013E-02  1.008E-02 ( -0.5%)
63  eu154      6.250E-05  6.127E-05 ( -2.0%)

```

japan power demonstration reactor bwr

measured and computed irradiated fuel composition

fuel assembly a-20, rod e2, node 03, 5.602 gwd/mtu

run august 1997

..compares cases using 44GROUPNDF5 library..

nuclide, z & name measured 44GROUPNDF5 %diff

units: milligrams/gram u

92	u234	1.404E-01	1.401E-01	(-0.2%)
92	u235	2.019E+01	2.005E+01	(-0.7%)
92	u236	1.177E+00	1.184E+00	(0.6%)
92	u238	9.700E+02	9.699E+02	(0.0%)
94	pu238	2.779E-03	2.412E-03	(-13.2%)
94	pu239	2.257E+00	2.222E+00	(-1.5%)
94	pu240	2.644E-01	2.709E-01	(2.4%)
94	pu241	5.623E-02	5.156E-02	(-8.3%)
94	pu242	3.793E-03	3.675E-03	(-3.1%)
93	np237	3.579E-02	3.526E-02	(-1.5%)
95	am241	1.424E-02	1.455E-02	(2.2%)
95	am242	3.680E-05	5.006E-05	(36.0%)
96	cm242	5.950E-07	6.628E-07	(11.4%)
96	cm244	4.060E-06	3.353E-06	(-17.4%)
44	ru106	4.545E-04	6.506E-04	(43.1%)
55	cs134	7.320E-04	7.610E-04	(4.0%)
55	cs137	1.781E-01	1.851E-01	(3.9%)
58	ce144	7.915E-04	1.480E-03	(87.0%)
60	nd143	1.926E-01	1.931E-01	(0.3%)
60	nd144	1.998E-01	1.989E-01	(-0.4%)
60	nd145	1.355E-01	1.359E-01	(0.3%)
60	nd146	1.105E-01	1.103E-01	(-0.2%)
60	nd148	6.273E-02	6.276E-02	(0.1%)
60	nd150	2.718E-02	2.708E-02	(-0.4%)
63	eu154	4.964E-04	4.683E-04	(-5.7%)
63	eu155	5.319E-04	3.016E-04	(-43.3%)

japan power demonstration reactor bwr

measured and computed irradiated fuel composition

fuel assembly a-20, rod e2, node 10, 5.377 gwd/mtu

run august 1997

..compares cases using 44GROUPNDF5 library..

nuclide, z & name measured 44GROUPNDF5 %diff

units: milligrams/gram u

92	u234	1.415E-01	1.415E-01	(0.0%)
92	u235	2.015E+01	2.014E+01	(0.0%)
92	u236	1.162E+00	1.143E+00	(-1.7%)
92	u238	9.706E+02	9.704E+02	(0.0%)
94	pu238	2.103E-03	1.748E-03	(-16.9%)
94	pu239	1.964E+00	1.945E+00	(-0.9%)
94	pu240	2.353E-01	2.358E-01	(0.2%)
94	pu241	4.248E-02	3.860E-02	(-9.1%)
94	pu242	2.866E-03	2.677E-03	(-6.6%)
93	np237	3.021E-02	2.868E-02	(-5.1%)
95	am241	1.124E-02	1.084E-02	(-3.5%)
95	am242	3.310E-05	3.409E-05	(3.0%)
96	cm242	4.380E-07	4.547E-07	(3.8%)
96	cm244	2.260E-06	1.670E-06	(-26.1%)
44	ru106	3.698E-04	5.756E-04	(55.7%)
55	cs134	5.844E-04	6.333E-04	(8.4%)
55	cs137	1.712E-01	1.780E-01	(4.0%)
58	ce144	7.055E-04	1.437E-03	(103.6%)
60	nd143	1.871E-01	1.869E-01	(-0.1%)
60	nd144	1.949E-01	1.925E-01	(-1.2%)
60	nd145	1.312E-01	1.315E-01	(0.2%)
60	nd146	1.061E-01	1.059E-01	(-0.1%)
60	nd148	6.029E-02	6.024E-02	(-0.1%)
60	nd150	2.580E-02	2.567E-02	(-0.5%)
63	eu154	3.943E-04	3.846E-04	(-2.5%)
63	eu155	5.033E-04	2.884E-04	(-42.7%)

APPENDIX H

SENSITIVITY OF CALCULATED CONCENTRATIONS TO ASSUMED MODERATOR DENSITY

In general, axial moderator densities are not reported as part of the spent fuel operating history associated with chemical assay data. Therefore, it is incumbent upon the modeler to estimate moderator densities. Experience with spent fuel modeling suggests that detailed time-varying models are not necessary; however, it is important to obtain a good estimate of the time-averaged moderator density at an axial location to best calculate spent fuel compositions.

One of the largest uncertainties in the current sets of models for the Cooper and Gundremmingen BWRs is the moderator density. This factor was not a problem for JPDR, because moderator densities were specified in published data describing the experiment. In this work, coarse estimates of moderator densities in the Cooper and Gundremmingen models were obtained using a simplistic conservation model. Comparison of results between Cooper and Gundremmingen relative to JPDR shows that, in general, isotopic concentrations are better for JPDR relative to the other two reactor fuels. Note, however, that JPDR fuel possesses low burnup relative to the other fuel samples, and would therefore also be expected to have less calculated/measured error than the other fuel samples. Nevertheless, it was felt necessary to try to assess the potential error in spent fuel predictions for Cooper and Gundremmingen due to uncertainties in time-averaged moderator densities.

Calculations were performed for four selected cases, taking a high nominal moderator density case (located axially low in the fuel rod) and low moderator density case (located axially high in the fuel rod), for each of the two reactors. The magnitude of the nominal density for each was varied by $\pm 20\%$, and the depletion calculations were rerun for each new density. A value of 20% was assumed as this was felt to bound the uncertainty in derived moderator densities. Tables H.1 through H.4 list the calculated concentrations for each of the most important spent fuel nuclides. The table lists the nuclide concentrations for nominal moderator density (as used in the primary analyses described in the body of this report) and for each perturbed density. After each perturbed-density concentration, the error relative to the nominal density case is shown. Similarly, Tables H-5 through H-8 list the calculated-to-measured ratios for the same conditions. In these tables, isotopic concentrations computed for the nominal and adjusted moderator densities are

compared with measured data. Percentage differences illustrate the differences between calculated concentrations and measured data for each perturbation. These comparisons illustrate the potential magnitude of isotopic variations as a function of variable.

Based on the results presented in these tables, the following observations are made:

- Sensitivity to moderator density appears to be close to linear for most nuclides (i.e., given a Δx change in nuclide concentration for a 20% moderator density increase); for a 20% decrease in moderator density, an approximate nuclide concentration change of $-\Delta x$ is observed.
- The actinides most sensitive to density changes are ^{235}U , ^{238}Pu , ^{239}Pu , ^{241}Pu and ^{241}Am . ^{241}Am sensitivity closely follows that of ^{241}Pu , since the former is produced largely by the decay of the latter.
- Decreased density results in increased quantities of the above actinides, and vice versa. Decreased density results in spectral hardening, which in turn results in greater Pu production from ^{238}U neutron capture, and decreased ^{235}U depletion due to increased Pu fission.
- Of the fission products, only ^{149}Sm , ^{151}Sm , and, to a lesser extent, ^{135}Cs , are sensitive to density changes; all three increase with decreasing moderator density. The two Sm nuclides are produced more rapidly by Pu fission than U fission, and therefore are expected to increase in concentration with spectral hardening.
- No definite conclusions can be drawn as to the appropriateness of the assumed (nominal) moderator densities for these cases. The tables show that for some nuclides the lower density improves agreement with the experiment; for other nuclides, the same is true for the higher-density calculation. For the remainder of the nuclides, the nominal density calculations result in the best agreement with measured data.

Table H.1. Sensitivity of predicted concentrations to moderator density for a low-average-density Cooper fuel sample

cooper nuclear station bwr
 atm-105, fuel assembly CZ346, rod c3, 350.1 cm ht., 17.84 gwd/mtu
 the standard moderator density (std den, in heading) for case: 0.3452 g/cc
 run march 1998

concentrations in milligrams/gram uo2

nuclide, z & name	std den	20% more den	%dif	20% less den	%dif
92 u234	1.724E-01	1.737E-01 (0.7%)		1.710E-01 (-0.8%)	
92 u235	1.236E+01	1.220E+01 (-1.3%)		1.253E+01 (1.4%)	
92 u236	2.512E+00	2.511E+00 (-0.1%)		2.517E+00 (0.2%)	
92 u238	8.439E+02	8.443E+02 (0.0%)		8.435E+02 (-0.1%)	
94 pu238	4.593E-02	4.297E-02 (-6.4%)		4.927E-02 (7.3%)	
94 pu239	3.900E+00	3.718E+00 (-4.7%)		4.102E+00 (5.2%)	
94 pu240	1.162E+00	1.141E+00 (-1.8%)		1.185E+00 (2.0%)	
94 pu241	3.669E-01	3.509E-01 (-4.4%)		3.828E-01 (4.3%)	
94 pu242	1.036E-01	1.018E-01 (-1.7%)		1.049E-01 (1.3%)	
95 am241	1.776E-01	1.695E-01 (-4.5%)		1.857E-01 (4.5%)	
43 tc 99	3.948E-01	3.962E-01 (0.4%)		3.932E-01 (-0.4%)	
55 cs133	5.810E-01	5.832E-01 (0.4%)		5.786E-01 (-0.4%)	
55 cs135	3.475E-01	3.407E-01 (-2.0%)		3.551E-01 (2.2%)	
60 nd143	4.578E-01	4.572E-01 (-0.1%)		4.583E-01 (0.1%)	
60 nd145	3.482E-01	3.499E-01 (0.5%)		3.464E-01 (-0.5%)	
62 sm147	1.535E-01	1.555E-01 (1.3%)		1.514E-01 (-1.4%)	
62 sm149	1.502E-03	1.421E-03 (-5.4%)		1.598E-03 (6.4%)	
62 sm150	1.229E-01	1.224E-01 (-0.4%)		1.235E-01 (0.5%)	
62 sm151	8.881E-03	8.419E-03 (-5.2%)		9.415E-03 (6.0%)	
62 sm152	6.621E-02	6.684E-02 (1.0%)		6.549E-02 (-1.1%)	
63 eu153	4.374E-02	4.316E-02 (-1.3%)		4.432E-02 (1.3%)	
64 gd155	9.503E-04	9.349E-04 (-1.6%)		9.680E-04 (1.9%)	

Table H.2. Sensitivity of predicted concentrations to moderator density for
a high-average-density Cooper fuel sample

cooper nuclear station bwr
atm-105, fuel assembly CZ346, rod c3, 114.7 cm ht., 31.04 gwd/mtu
the standard moderator density (std den, in heading) for case: 0.6124 g/cc
concentrations in milligrams/gram uo2
run march 1998

nuclide, z & name	std den	20% more den	%dif	20% less den	%dif
92 u234	1.446E-01	1.454E-01 (0.5%)		1.435E-01 (-0.8%)	
92 u235	5.544E+00	5.199E+00 (-6.2%)		5.943E+00 (7.2%)	
92 u236	3.409E+00	3.426E+00 (0.5%)		3.393E+00 (-0.5%)	
92 u238	8.366E+02	8.372E+02 (0.1%)		8.357E+02 (-0.1%)	
94 pu238	1.294E-01	1.203E-01 (-7.0%)		1.405E-01 (8.6%)	
94 pu239	3.510E+00	3.259E+00 (-7.2%)		3.832E+00 (9.2%)	
94 pu240	1.924E+00	1.890E+00 (-1.8%)		1.970E+00 (2.4%)	
94 pu241	5.979E-01	5.594E-01 (-6.4%)		6.443E-01 (7.8%)	
94 pu242	4.031E-01	4.016E-01 (-0.4%)		4.028E-01 (-0.1%)	
95 am241	2.663E-01	2.474E-01 (-7.1%)		2.891E-01 (8.6%)	
43 tc 99	6.585E-01	6.618E-01 (0.5%)		6.545E-01 (-0.6%)	
55 cs133	9.627E-01	9.672E-01 (0.5%)		9.571E-01 (-0.6%)	
55 cs135	3.916E-01	3.761E-01 (-4.0%)		4.106E-01 (4.8%)	
60 nd143	6.284E-01	6.172E-01 (-1.8%)		6.405E-01 (1.9%)	
60 nd145	5.648E-01	5.677E-01 (0.5%)		5.611E-01 (-0.7%)	
62 sm147	2.195E-01	2.232E-01 (1.7%)		2.150E-01 (-2.1%)	
62 sm149	1.267E-03	1.204E-03 (-5.0%)		1.391E-03 (9.8%)	
62 sm150	2.237E-01	2.219E-01 (-0.8%)		2.257E-01 (0.9%)	
62 sm151	8.449E-03	7.789E-03 (-7.8%)		9.326E-03 (10.4%)	
62 sm152	1.143E-01	1.158E-01 (1.3%)		1.124E-01 (-1.7%)	
63 eu153	9.338E-02	9.238E-02 (-1.1%)		9.441E-02 (1.1%)	
64 gd155	2.246E-03	2.221E-03 (-1.1%)		2.279E-03 (1.5%)	

Table H.3. Sensitivity of predicted concentrations to moderator density for
a low-average-density Gundremmingen fuel sample

gundremmingen bwr
fuel assembly b23, rod a1, 268 cm height, 27.400 gwd/mtu
the standard moderator density (std den, in heading) for case: 0.3145 g/cc
concentrations in milligrams/gram uranium
run march 1998

nuclide, z & name	std den	20% more den	%dif	20% less den	%dif
92 u234	1.417E-01	1.424E-01 (0.5%)		1.410E-01 (-0.5%)	
92 u235	6.424E+00	6.254E+00 (-2.6%)		6.591E+00 (2.6%)	
92 u236	3.248E+00	3.250E+00 (0.1%)		3.249E+00 (0.0%)	
92 u238	9.528E+02	9.531E+02 (0.0%)		9.524E+02 (0.0%)	
94 pu238	1.169E-01	1.125E-01 (-3.8%)		1.216E-01 (4.0%)	
94 pu239	4.733E+00	4.563E+00 (-3.6%)		4.909E+00 (3.7%)	
94 pu240	2.184E+00	2.156E+00 (-1.3%)		2.217E+00 (1.5%)	
94 pu241	8.596E-01	8.394E-01 (-2.4%)		8.775E-01 (2.1%)	
94 pu242	3.941E-01	3.986E-01 (1.1%)		3.880E-01 (-1.6%)	
95 am241	1.707E-01	1.664E-01 (-2.5%)		1.745E-01 (2.2%)	
43 tc 99	6.583E-01	6.600E-01 (0.3%)		6.564E-01 (-0.3%)	
55 cs133	9.629E-01	9.655E-01 (0.3%)		9.600E-01 (-0.3%)	
55 cs135	3.276E-01	3.198E-01 (-2.4%)		3.359E-01 (2.5%)	
60 nd143	6.601E-01	6.557E-01 (-0.7%)		6.643E-01 (0.6%)	
60 nd145	5.592E-01	5.611E-01 (0.3%)		5.572E-01 (-0.4%)	
62 sm147	1.596E-01	1.611E-01 (1.0%)		1.579E-01 (-1.0%)	
62 sm149	2.500E-03	2.414E-03 (-3.4%)		2.592E-03 (3.7%)	
62 sm150	2.428E-01	2.416E-01 (-0.5%)		2.438E-01 (0.4%)	
62 sm151	1.167E-02	1.113E-02 (-4.7%)		1.224E-02 (4.9%)	
62 sm152	1.160E-01	1.167E-01 (0.6%)		1.152E-01 (-0.7%)	
63 eu153	9.461E-02	9.451E-02 (-0.1%)		9.456E-02 (0.0%)	
64 gd155	1.573E-03	1.562E-03 (-0.7%)		1.585E-03 (0.8%)	

Table H.4. Sensitivity of predicted concentrations to moderator density for a high-average-density Gundremmingen fuel sample

gundremmingen bwr
 fuel assembly b23, rod a1, 44 cm height, 25.730 gwd/mtu
 the standard moderator density (std den, in heading) for case: 0.7378 g/cc
 concentrations in milligrams/gram uranium
 run march 1998

nuclide, z & name	std den	20% more den	%dif	20% less den	%dif
92 u234	1.498E-01	1.506E-01 (0.5%)		1.488E-01 (-0.7%)	
92 u235	6.053E+00	5.769E+00 (-4.7%)		6.376E+00 (5.3%)	
92 u236	3.198E+00	3.215E+00 (0.5%)		3.182E+00 (-0.5%)	
92 u238	9.564E+02	9.569E+02 (0.1%)		9.557E+02 (-0.1%)	
94 pu238	8.123E-02	7.611E-02 (-6.3%)		8.738E-02 (7.6%)	
94 pu239	3.791E+00	3.577E+00 (-5.6%)		4.052E+00 (6.9%)	
94 pu240	1.940E+00	1.915E+00 (-1.3%)		1.973E+00 (1.7%)	
94 pu241	6.847E-01	6.492E-01 (-5.2%)		7.255E-01 (6.0%)	
94 pu242	3.500E-01	3.487E-01 (-0.4%)		3.501E-01 (0.0%)	
95 am241	1.346E-01	1.271E-01 (-5.6%)		1.432E-01 (6.4%)	
43 tc 99	6.319E-01	6.341E-01 (0.4%)		6.292E-01 (-0.4%)	
55 cs133	9.250E-01	9.281E-01 (0.3%)		9.213E-01 (-0.4%)	
55 cs135	2.815E-01	2.718E-01 (-3.5%)		2.934E-01 (4.2%)	
60 nd143	6.132E-01	6.056E-01 (-1.2%)		6.214E-01 (1.3%)	
60 nd145	5.408E-01	5.430E-01 (0.4%)		5.381E-01 (-0.5%)	
62 sm147	1.632E-01	1.653E-01 (1.3%)		1.609E-01 (-1.4%)	
62 sm149	1.983E-03	1.897E-03 (-4.3%)		2.102E-03 (6.0%)	
62 sm150	2.216E-01	2.191E-01 (-1.1%)		2.235E-01 (0.9%)	
62 sm151	8.749E-03	8.177E-03 (-6.5%)		9.467E-03 (8.2%)	
62 sm152	1.136E-01	1.146E-01 (0.9%)		1.124E-01 (-1.1%)	
63 eu153	8.493E-02	8.412E-02 (-0.9%)		8.574E-02 (1.0%)	
64 gd155	1.364E-03	1.351E-03 (-1.0%)			

Table H.5. Sensitivity of predicted-to-measured ratios to moderator density for a low-average-density Cooper fuel sample

cooper nuclear station bwr

increased and decreased moderator density by 20%

atm-105, fuel assembly CZ346, rod c3, 350.1 cm ht., 17.84 gwd/mtu

the standard moderator density for case0.3452 g/cc

run august 1998

concentrations in milligrams/gram uo2

nuclide, z & name	measured	nominal calc	%dif	20% more den	%dif	20% less den	%dif
92 u234	1.740E-01	1.724E-01	(-0.9%)	1.737E-01	(-0.2%)	1.710E-01	(-1.7%)
92 u235	1.300E+01	1.236E+01	(-4.9%)	1.220E+01	(-6.2%)	1.253E+01	(-3.6%)
92 u236	2.480E+00	2.512E+00	(1.3%)	2.511E+00	(1.2%)	2.517E+00	(1.5%)
92 u238	8.545E+02	8.439E+02	(-1.2%)	8.443E+02	(-1.2%)	8.435E+02	(-1.3%)
94 pu238	5.210E-02	4.593E-02	(-11.9%)	4.297E-02	(-17.5%)	4.927E-02	(-5.4%)
94 pu239	4.056E+00	3.900E+00	(-3.9%)	3.718E+00	(-8.3%)	4.102E+00	(1.1%)
94 pu240	1.184E+00	1.162E+00	(-1.9%)	1.141E+00	(-3.6%)	1.185E+00	(0.1%)
94 pu241	3.415E-01	3.669E-01	(7.4%)	3.509E-01	(2.8%)	3.828E-01	(12.1%)
94 pu242	8.742E-02	1.036E-01	(18.5%)	1.018E-01	(16.5%)	1.049E-01	(20.0%)
93 np237	1.546E-01	1.703E-01	(10.1%)	1.627E-01	(5.2%)	1.785E-01	(15.5%)
95 am241	1.524E-01	1.776E-01	(16.5%)	1.695E-01	(11.3%)	1.857E-01	(21.8%)
96 cm244	1.375E-03	1.403E-03	(2.0%)	1.230E-03	(-10.5%)	1.609E-03	(17.0%)
34 se 79	1.968E-03	2.377E-03	(20.8%)	2.382E-03	(21.0%)	2.371E-03	(20.5%)
38 sr 90	2.070E-01	2.294E-01	(10.8%)	2.312E-01	(11.7%)	2.274E-01	(9.9%)
43 tc 99	3.607E-01	3.948E-01	(9.5%)	3.962E-01	(9.9%)	3.932E-01	(9.0%)
50 sn126	2.587E-03	7.767E-03	(200.2%)	7.692E-03	(197.3%)	7.840E-03	(203.1%)
55 cs135	3.326E-01	3.475E-01	(4.5%)	3.407E-01	(2.4%)	3.551E-01	(6.8%)
55 cs137	4.657E-01	4.794E-01	(2.9%)	4.798E-01	(3.0%)	4.790E-01	(2.8%)

Table H.6. Sensitivity of predicted-to-measured ratios to moderator density for a high-average-density Cooper fuel sample

cooper nuclear station bwr
increased and decreased moderator density by 20%
atm-105, fuel assembly CZ346, rod c3, 114.7 cm ht., 31.04 gwd/mtu
the standard moderator density for case0.6124 g/cc
run august 1998
concentrations in milligrams/gram uo2

nuclide, z & name	measured	nominal calc	%dif	20% more den	%dif	20% less den	%dif
92 u234	1.540E-01	1.446E-01	(-6.1%)	1.454E-01	(-5.6%)	1.435E-01	(-6.8%)
92 u235	6.280E+00	5.544E+00	(-11.7%)	5.199E+00	(-17.2%)	5.943E+00	(-5.4%)
92 u236	3.480E+00	3.409E+00	(-2.0%)	3.426E+00	(-1.6%)	3.393E+00	(-2.5%)
92 u238	8.455E+02	8.366E+02	(-1.1%)	8.372E+02	(-1.0%)	8.357E+02	(-1.2%)
94 pu238	1.389E-01	1.294E-01	(-6.9%)	1.203E-01	(-13.4%)	1.405E-01	(1.2%)
94 pu239	3.668E+00	3.510E+00	(-4.3%)	3.259E+00	(-11.2%)	3.832E+00	(4.5%)
94 pu240	2.082E+00	1.924E+00	(-7.6%)	1.890E+00	(-9.2%)	1.970E+00	(-5.4%)
94 pu241	6.139E-01	5.979E-01	(-2.6%)	5.594E-01	(-8.9%)	6.443E-01	(4.9%)
94 pu242	3.823E-01	4.031E-01	(5.4%)	4.016E-01	(5.1%)	4.028E-01	(5.4%)
93 np237	3.348E-01	2.986E-01	(-10.8%)	2.826E-01	(-15.6%)	3.172E-01	(-5.2%)
95 am241	2.533E-01	2.663E-01	(5.2%)	2.474E-01	(-2.3%)	2.891E-01	(14.1%)
96 cm244	1.306E-02	1.344E-02	(2.9%)	1.188E-02	(-9.1%)	1.539E-02	(17.9%)
34 se 79	3.280E-03	4.056E-03	(23.6%)	4.065E-03	(23.9%)	4.045E-03	(23.3%)
38 sr 90	3.417E-01	3.677E-01	(7.6%)	3.714E-01	(8.7%)	3.634E-01	(6.3%)
43 tc 99	5.846E-01	6.585E-01	(12.6%)	6.618E-01	(13.2%)	6.545E-01	(12.0%)
50 sn126	5.146E-03	1.549E-02	(201.0%)	1.532E-02	(197.8%)	1.567E-02	(204.6%)
55 cs135	3.743E-01	3.916E-01	(4.6%)	3.761E-01	(0.5%)	4.106E-01	(9.7%)
55 cs137	7.877E-01	8.365E-01	(6.2%)	8.372E-01	(6.3%)	8.356E-01	(6.1%)

Table H.7. Sensitivity of predicted-to-measured ratios to moderator density for a low-average-density Gundremmingen fuel sample

gundremmingen bwr

increased and decreased moderator density by 20%

fuel assembly b23, rod a1, 268 cm height, 27.400 gwd/mtu

the standard moderator density for case0.3145 g/cc

run august 1998

concentrations in milligrams/gram uo2

nuclide, z & name	measured	nominal calc	%dif	20% more den	%dif	20% less den	%dif
92 u235	6.741E+00	6.424E+00	(-4.7%)	6.254E+00	(-7.2%)	6.591E+00	(-2.2%)
92 u236	3.294E+00	3.248E+00	(-1.4%)	3.250E+00	(-1.3%)	3.249E+00	(-1.4%)
92 u238	9.519E+02	9.528E+02	(0.1%)	9.531E+02	(0.1%)	9.524E+02	(0.0%)
94 pu238	1.080E-01	1.169E-01	(8.2%)	1.125E-01	(4.2%)	1.216E-01	(12.6%)
94 pu239	4.800E+00	4.733E+00	(-1.4%)	4.563E+00	(-4.9%)	4.909E+00	(2.3%)
94 pu240	2.168E+00	2.184E+00	(0.7%)	2.156E+00	(-0.5%)	2.217E+00	(2.2%)
94 pu241	9.540E-01	8.596E-01	(-9.9%)	8.394E-01	(-12.0%)	8.775E-01	(-8.0%)
94 pu242	4.494E-01	3.941E-01	(-12.3%)	3.986E-01	(-11.3%)	3.880E-01	(-13.7%)
96 cm244	1.977E-02	1.811E-02	(-8.4%)	1.703E-02	(-13.9%)	1.931E-02	(-2.3%)
55 cs134	2.490E-02	2.872E-02	(15.3%)	2.831E-02	(13.7%)	2.917E-02	(17.1%)
55 cs137	8.085E-01	9.478E-01	(17.2%)	9.484E-01	(17.3%)	9.470E-01	(17.1%)
60 nd148	3.088E-01	3.024E-01	(-2.1%)	3.024E-01	(-2.1%)	3.024E-01	(-2.1%)
63 eu154	1.372E-02	1.368E-02	(-0.3%)	1.317E-02	(-4.0%)	1.424E-02	(3.8%)

Table H.8. Sensitivity of predicted-to-measured ratios to moderator density for a high-average-density Gundremmingen fuel sample

gundremmingen bwr
increased and decreased moderator density by 20%
fuel assembly b23, rod a1, 44 cm height, 25.730 gwd/mtu
the standard moderator density for case0.7378 g/cc
run august 1998
concentrations in milligrams/gram uo2

nuclide, z & name	measured	nominal calc	%dif	20% more den	%dif	20% less den	%dif
92 u235	6.307E+00	6.053E+00	(-4.0%)	5.769E+00	(-8.5%)	6.376E+00	(1.1%)
92 u236	3.280E+00	3.198E+00	(-2.5%)	3.215E+00	(-2.0%)	3.182E+00	(-3.0%)
92 u238	9.561E+02	9.564E+02	(0.0%)	9.569E+02	(0.1%)	9.557E+02	(0.0%)
94 pu238	6.800E-02	8.123E-02	(19.5%)	7.611E-02	(11.9%)	8.738E-02	(28.5%)
94 pu239	3.736E+00	3.791E+00	(1.5%)	3.577E+00	(-4.3%)	4.052E+00	(8.5%)
94 pu240	1.815E+00	1.940E+00	(6.9%)	1.915E+00	(5.5%)	1.973E+00	(8.7%)
94 pu241	7.052E-01	6.847E-01	(-2.9%)	6.492E-01	(-7.9%)	7.255E-01	(2.9%)
94 pu242	3.305E-01	3.500E-01	(5.9%)	3.487E-01	(5.5%)	3.501E-01	(5.9%)
96 cm244	8.868E-03	9.235E-03	(4.1%)	8.238E-03	(-7.1%)	1.047E-02	(18.1%)
55 cs134	2.675E-02	2.346E-02	(-12.3%)	2.294E-02	(-14.3%)	2.407E-02	(-10.0%)
55 cs137	1.028E+00	8.935E-01	(-13.1%)	8.942E-01	(-13.0%)	8.926E-01	(-13.2%)
60 nd148	2.899E-01	2.842E-01	(-2.0%)	2.842E-01	(-2.0%)	2.842E-01	(-2.0%)
63 eu154	1.372E-02	9.919E-03	(-27.7%)	9.397E-03	(-31.5%)	1.057E-02	(-23.0%)

INTERNAL DISTRIBUTION

- | | |
|----------------------|------------------------------|
| 1. C. W. Alexander | 34. L. M. Petrie |
| 2. S. M. Bowman | 35. R. T. Primm |
| 3. B. L. Broadhead | 36. J.-P. Renier |
| 4. J. A. Bucholz | 37. J. W. Roddy |
| 5–9. W. C. Carter | 38. R. W. Roussin |
| 10. R. D. Dabbs | 39. J. C. Ryman |
| 11–15. M. D. DeHart | 40. C. H. Shappert |
| 16. M. B. Emmett | 41. C. O. Slater |
| 17–21. O. W. Hermann | 42–44. R. M. Westfall |
| 22. M. A. Kuliasha | 45. B. A. Worley |
| 23. L. C. Leal | 46. R. Q. Wright |
| 24. S. B. Ludwig | 47. Laboratory Records-RC |
| 25. S. K. Martin | 48. Central Research Library |
| 26. G. E. Michaels | |
| 27. B. D. Murphy | |
| 28. J. V. Pace | |
| 29–33. C. V. Parks | |

EXTERNAL DISTRIBUTION

49. M. L. Anderson, Framatome Cogema Fuels, 1261 Town Center Drive, Las Vegas, Nevada 89134
50. M. G. Bailey, Office of Nuclear Material Safety & Safeguards, U.S. Nuclear Regulatory Commission, MS O6 G22, Washington, DC 20555
51. L. Barrett, Office of Civilian Radioactive Waste Management, RW-232 20545, U.S. Department of Energy, Washington, DC 20545
52. C. J. Benson, Bettis Atomic Power Laboratory, P.O. Box 79, West Mifflin, PA 15122
53. R. J. Cacciapouti, Yankee Atomic Electric Co., 1617 Worcester Rd., Framington, MA 01701
54. D. E. Carlson, U.S. Nuclear Regulatory Commission, Spent Fuel Project Office, MS O6 G22, Washington, DC 20555
55. J. Clark, 2650 Park Tower Drive, Suite 800, Vienna, VA 22180
56. J. Conde, Consejo de Seguridad Nuclear, Justo Dorado, 11, 28040 Madrid, Spain
57. D. R. Conners, Bettis Atomic Power Laboratory, P.O. Box 79, West Mifflin, PA 15122
58. W. Davis, Framatome Cogema Fuels, 1261 Town Center Drive, Las Vegas, Nevada 89134
59. T. W. Doering, Framatome Cogema Fuels, 1261 Town Center Drive, Las Vegas, Nevada 89134

60. I. Gauld, Whiteshell Laboratories, AECL Research, Pinawa Manitoba R0E1L0 Canada
61. G. Gualdrini, ENEA-TIB/FICS, C.R.E. "E. Clementel," Via Mazzini, 2, I-40139 Bologna, Italy
62. H. Geiser, Wissenschaftlich-Technische Ingenieurberatung GmbH, P.O. Box 13 40, 52410 Julich, Federal Republic of Germany
63. S. Hanauer, U.S. Department of Energy, RW-22, Washington, DC 20545
64. C. J. Haughney, U.S. Nuclear Regulatory Commission, Spent Fuel Project Office, OWFN 6 F18, Washington, DC 20555
65. L. Hassler, Babcock & Wilcox, P.O. Box 10935, Lynchburg, VA 24506-0935
66. D. Henderson, Framatome Cogema, 1261 Town Center Drive, Las Vegas, Nevada 89134
67. U. Jenquin, Battelle Pacific Northwest Laboratory, P.O. Box 999, Richland, WA 99352
68. E. Johnson, E. R. Johnson Associates, Inc., 9302 Lee Hwy, Suite 200, Fairfax, VA 22031
69. G. Kirchner, University of Bremen, FB 1 Postfach 330440, D-W-2800 Bremen 33, Federal Republic of Germany
70. C. Kouts, Office of Civilian Radioactive Waste Management, RW-36, U.S. Department of Energy, Washington, DC 20545
71. W. H. Lake, Office of Civilian Radioactive Waste Management, U.S. Department of Energy, RW-46, Washington, DC 20585
72. R. Lambert, Electric Power Research Institute, 3412 Hillview Ave., Palo Alto, CA 94304
73. D. Lancaster, 2650 Park Tower Drive, Suite 800, Vienna, VA 22180
74. D. Langstaff, U.S. Department of Energy, Richland Operations Office, P.O. Box 550, Richland, WA 99352
75. Y. L. Liu, Argonne National Laboratory, 9700 S. Cass Ave., Bldg.308, Argonne, IL 60439-4825
76. M. Mason, Transnuclear, Two Skyline Drive, Hawthorne, NY 10532-2120
77. M. Mount, Lawrence Livermore National Laboratory, P.O. Box 808, Livermore, CA 94550
78. P. K. Nair, Manager, Engineered Barrier System, Center for Nuclear Waste Regulatory Analyses, Southwest Research Institute, 6220 Culebra Road, San Antonio, TX 78238-5166
79. D. Napolitano, Nuclear Assurance Corp., 5720 Peachtree Parkway, Norcross, GA 30092
80. K. A. Neimer, Duke Engineering & Services, 230 S. Tyron St., P.O. Box 1004, Charlotte, NC 28201-1004
81. C. W. Nilsen, Office of Nuclear Material Safety and Safeguards, U.S. Nuclear Regulatory Commission, MS T9 F31, Washington, DC 20555
- 82-83. Office of Scientific and Technical Information, U.S. Department of Energy, P.O. Box 62, Oak Ridge, TN 37831
84. Office of the Assistant Manager for Energy Research and Development, Department of Energy Oak Ridge Operations (DOE-ORO), P.O. Box 2008, Oak Ridge, TN 37831
85. N. L. Osgood, U.S. Nuclear Regulatory Commission, Office of Nuclear Materials Safety and Safeguards, MS O6 F18, Washington, DC 20555
86. O. Ozer, Electric Power Research Institute, 3412 Hillview Ave., Palo Alto, CA 94304
86. T. Parish, Department of Nuclear Engineering, Texas A & M University, College Station, TX 77843-3313

88. B. Reid, Battelle Pacific Northwest Laboratory, P.O. Box 999, Richland, WA 99352
89. C. Rombough, CTR Technical Services, Inc., 5619 Misty Crest Dr., Arlington, TX 76017-4147
90. M. Smith, U.S. Department of Energy, Yucca Mountain Project Office, 101 Convention Center Dr., Las Vegas, NV 89190
91. M. Smith, Virginia Power Co., P.O. Box 2666, Richmond, VA 23261
92. F. C. Sturz, Office of Nuclear Material Safety & Safeguards, U.S. Nuclear Regulatory Commission, MS O6 G22, Washington, DC 20555
93. T. Suto, Power Reactor and Nuclear Fuel Development Corp., 1-9-13, Akasaka, Minato-Ku, Tokyo, Japan
94. R. J. Talbert, Battelle Pacific Northwest Laboratory, P.O. Box 999, Richland, WA 99352
95. H. Taniuchi, Kobe Steel, Ltd., 2-3-1 Shinhama, Arai-Cho, Takasago, 676 Japan
96. D. A. Thomas, Framatome Cogema, 1261 Town Center Drive, Las Vegas, Nevada 89134
97. J. R. Thornton, Duke Engineering & Services, 230 S. Tyron St., P.O. Box 1004, Charlotte, NC 28201-1004
98. J. Vujic, Department of Nuclear Engineering, University of California at Berkeley, Berkeley, CA 94720
99. G. Walden, Duke Power Co., P.O. Box 33189, Charlotte, NC 28242
100. M. E. Wangler, U.S. Department of Energy, EH-33.2, Washington, DC 20585-0002
101. R. M. Weller, U.S. Nuclear Regulatory Commission, MS T7 C6, Washington, DC 20555
102. A. Wells, 2846 Peachtree Walk, Duluth, GA 30136
103. W. Weyer, Wissenschaftlich-Technische Ingenieurberatung GMBH, Mozartstrasse 13, 5177 Titz-Rodingen, Federal Republic of Germany
104. B. H. White, U.S. Nuclear Regulatory Commission, Spent Fuel Project Office, MS O6 F18, Washington, DC 20555
105. J. Williams, Office of Civilian Radioactive Waste Management, U.S. Department of Energy, RW-46, Washington, DC 20545
106. M. L. Williams, LSU Nuclear Science Center, Baton Rouge, LA 70803
107. C. J. Withee, U.S. Nuclear Regulatory Commission, Spent Fuel Project Office, MS O6 G22, Washington, DC 20555
108. R. Yang, Electric Power Research Institute, 3412 Hillview Ave., Palo Alto, CA 94304

