

---

Final Technical Report

***Characterization of Min-K TE-1400 Thermal  
Insulation***

July 2008

**Principal Investigators:**

Dr. J. G. Hemrick  
Dr. E. Lara-Curzio  
Oak Ridge National Laboratory



Managed by UT-Battelle, LLC

ORNL/TM-2008/089

## DOCUMENT AVAILABILITY

Reports produced after January 1, 1996, are generally available free via the U.S. Department of Energy (DOE) Information Bridge.

**Web site** <http://www.osti.gov/bridge>

Reports produced before January 1, 1996, may be purchased by members of the public from the following source.

National Technical Information Service  
5285 Port Royal Road  
Springfield, VA 22161  
**Telephone** 703-605-6000 (1-800-553-6847)  
**TDD** 703-487-4639  
**Fax** 703-605-6900  
**E-mail** [info@ntis.fedworld.gov](mailto:info@ntis.fedworld.gov)  
**Web site** <http://www.ntis.gov/support/ordernowabout.htm>

Reports are available to DOE employees, DOE contractors, Energy Technology Data Exchange (ETDE) representatives, and International Nuclear Information System (INIS) representatives from the following source.

Office of Scientific and Technical Information  
P.O. Box 62  
Oak Ridge, TN 37831  
**Telephone** 865-576-8401  
**Fax** 865-576-5728  
**E-mail** [reports@adonis.osti.gov](mailto:reports@adonis.osti.gov)  
**Web site** <http://www.osti.gov/contact.html>

## FINAL TECHNICAL REPORT

**Project Title:** Characterization of Min-K TE-1400 Thermal Insulation

**Project Period:** April 1997 – July 2007

**PI(s):** Dr. J. G. Hemrick  
(865) 776-0758  
hemrickjg@ornl.gov

Dr. E. Lara-Curzio  
(865) 574-1749  
laracurzioe@ornl.gov

**Recipient:** Oak Ridge National Laboratory (ORNL)  
Bethel Valley Road  
P. O. Box 2008  
Oak Ridge, TN 37831

**Subcontractor** Oak Ridge National Laboratory (ORNL)  
Bethel Valley Road  
P.O. Box 2008  
Oak Ridge, TN 37831



## **Characterization of Min-K TE-1400 Thermal Insulation**

James G. Hemrick<sup>1</sup>, Edgar Lara-Curzio<sup>1</sup>, and James F. King<sup>1</sup>

July 2008

Prepared by  
OAK RIDGE NATIONAL LABORATORY  
P.O. Box 2008  
Oak Ridge, Tennessee 37831-6283  
managed by  
UT-Battelle, LLC  
for the  
U.S. DEPARTMENT OF ENERGY  
under contract DE-AC05-00OR22725

---

<sup>1</sup> Oak Ridge National Laboratory, Material Science and Technology Division, Oak Ridge, TN



## **Table of Contents**

List of Tables and Figures.....	v
Abbreviations and Acronyms.....	vii
1. Executive Summary.....	1
2. Introduction.....	4
3. Room and High Temperature Compression Testing.....	4
3.1 Experimental Procedures.....	4
3.2 Results.....	5
4. Isothermal Stress Relaxation Testing.....	6
4.1 Experimental Procedures.....	6
4.2 Results.....	6
5. Gradient Stress Relaxation Testing.....	6
5.1 Experimental Procedures.....	6
5.2 Results.....	8
6. Additional Testing and Evaluation.....	11
6.1 Experimental Procedures.....	11
6.2 Results.....	11
7. Modeling.....	11
8. Lessons Learned.....	14
9. Acknowledgements.....	15
Tables and Figures.....	17
Appendix 1 Min-K Testing and Characterization Test Matrix: Preliminary Compression Tests.....	49
Appendix 2 Isothermal Stress Relaxation Plots.....	53
Appendix 3 Min-K Sample Densities with Respect to Batch Designations and Test Numbers.....	63
Distribution List.....	65





## **List of Tables and Figures**

### **Tables**

Table 1. Stress Relaxation Test Matrix.....	17
Table 2. Additional Long-Term Gradient Stress Relaxation Testing Matrix.....	17
Table 3. Elastic Modulus Values for Min-K TE1400 Under 1% Strain at Increasing Temperatures.....	17

### **Figures**

Figure 1. Experimental set-up for determination of compressive strength of Min-K.....	17
Figure 2. Sample Geometries for Initial Compression Testing.....	18
Figure 3. . Loading and Relaxation Schemes for Preliminary High Temperature Compression Testing.....	18
Figure 4. Results of Initial Compression Testing.....	21
Figure 5. Results from Preliminary High Temperature Compression Testing.....	24
Figure 6. Typical Results from High Temperature Compression Testing.....	26
Figure 7. Isothermal Stress Relaxation Test Frame.....	27
Figure 8. Typical Results from Isothermal Stress Relaxation Testing.....	29
Figure 9. Gradient Stress Relaxation Test Frame.....	30
Figure 10. Installed Back-Up Power Supply System for Gradient Test Systems.....	30
Figure 11. Picture of Modified Gradient Stress Relaxation Test Frame.....	31
Figure 12. Typical Result from Initial Gradient Stress Relaxation Testing.....	31
Figure 13. Results from Initial 700/100°C Gradient Stress Relaxation Test with Unloading Study at Conclusion of Test.....	32
Figure 14. Results from 800/190°C Gradient Stress Relaxation Test Ended Due to Loss of Top Platen.....	32
Figure 15. Results from Short-Term Loading Test to Evaluate Min-K Performance Under Actual Expected Loading Conditions – (a) Temperature Cycle, (b) Stress and Strain Behavior.....	33
Figure 16. Results from 700/100°C Gradient Stress Relaxation Test (Test #10).....	34
Figure 17. Results from 700/100°C Gradient Stress Relaxation Test (Test #11).....	34
Figure 18. Results from 700/100°C Gradient Stress Relaxation Test (Test #13).....	35
Figure 19. Results from 700/100°C Gradient Stress Relaxation Test (Test #15).....	35
Figure 20. Results to date from 1,100/300°F Gradient Stress Relaxation Test.....	36
Figure 21. Results to date from 1,000/160°F Gradient Stress Relaxation Test.....	36
Figure 22. Results from to date from 900//≈50°F Gradient Stress Relaxation Test.....	37
Figure 23. Results from Elastic Modulus Testing.....	37
Figure 24. Results from Thermal Conductivity Testing.....	38
Figure 25. Typical Results from SEM/EDS Analysis.....	39
Figure 26. Discretized Gradient Model.....	40
Figure 27. Comparison of Experimental Results to FEA Predictions.....	40
Figure 28. Comparison of Temperature Distributions Determined Experimentally and Extrapolated from FEA Model.....	41

Figure 29. Comparison of Experimental Data and FEA Predictions.....	41
Figure 30. Typical Results from Fitting of Closed Form Model.....	42
Figure 31. Examples of Curve Fit Convergence for Gradient Stress Relaxation Tests #10 and #11.....	44
Figure 32. Log Function Curve Fits of Long-Term Gradient Stress Relaxation Data (a – Test #13, b – Test #15).....	45
Figure 33. Gradient Test #13 Log Fit Predictions.....	46
Figure 34. Gradient Test #15 Log Fit Predictions.....	47

## **Abbreviations and Acronyms**

ASTM	American Society for Testing and Materials
DOE	U.S. Department of Energy
ORNL	Oak Ridge National Laboratory
SEM/EDS	scanning electron microscopy/energy dispersive spectroscopy
TSE	Transient Strain Events

NOTE: Units used in this document are those requested by the program sponsors. Where applicable, equivalent SI units are given.



## 1. Executive Summary

Min-K 1400TE<sup>2</sup> insulation material was characterized at Oak Ridge National Laboratory for use in structural applications under gradient temperature conditions. Initial compression testing was performed at room temperature at various loading rates ranging between 5 and 500 psi/hour ( $\approx 35$  and 3500 kPa/hour) to determine the effect of sample size and test specimen geometry on the compressive strength of Min-K. The results from these initial tests indicated that there was no effect of sample geometry on the monotonic compressive strength of Min-K. Therefore, subsequent testing was performed on cylindrical specimens. To determine the loading rates that would be used for stress relaxation testing, compression tests were next carried out at various levels followed by stress relaxation under constant strain at temperatures of 650, 850, and 900°C. Additional high temperature compression testing was performed with samples loaded at a rate of 53 psi/hour (365 kPa/hour) in three load steps of 50, 100 and 200 psi (345, 690, and 1380 kPa) with quick unload/load cycles between steps and followed by a hold period in load control (3 to 100 hours) to allow for sample creep. Testing was carried out at 190, 382, 813, and 850°C. The strain was found to recover to its previous level after the quick unloading/loading events and the hold step after achieving load successfully exhibited expected creep behavior, which increased with test temperature. Additional tests at original test temperatures verified repeatability of test results.

Isothermal stress relaxation testing was performed at temperatures of 190, 382, 813, and 850°C and initial loads of 100 and 200 psi (690 and 1380 kPa). Loading was performed in strain control utilizing a twelve-step loading scheme with loading every half hour at a rate of 5.56% strain/hour. Loading was then followed by stress relaxation at constant strain levels with testing carried out until the initial load was dissipated or had leveled off to a rate of change of less than 0.25 psi/hour (1.7 kPa/hour). After completion of the original isothermal stress relaxation testing, additional testing was undertaken at 550 and 650°C with maximum stresses of 100 and 200 psi (690 and 1380 kPa).

Gradient stress relaxation testing was intended to be performed at temperatures of 850/450°C and 450/190°C with initial loads of 100 or 200 psi (690 and 1380 kPa) performed under constant strain utilizing a twelve-step loading scheme with loading every half hour at a rate of 5.56% strain/hour. Loading was followed by stress relaxation under constant strain with initial testing carried out until the initial load was dissipated or had leveled off to a rate of change of less than 0.25 psi/hour. (1.7 kPa/hour) (up to 2000 hours). Initial gradient stress relaxation testing was completed, although under slightly different thermal conditions than the originally proposed 850/450°C and 450/190°C with a maximum initial stress of 100 and 200 psi (690 and 1380 kPa). The duration of these tests spanned between 100 and 1300 hours.

Following completion of the initial isothermal and temperature gradient stress relaxation testing, an effort was undertaken to convert the two current isothermal stress relaxation frames to gradient stress relaxation frames and to improve the robustness of the gradient stress relaxation test set-up in an effort to complete tests of six-month to one-year duration. To facilitate this, the test frames were retrofitted with new heater platens,

---

<sup>2</sup> Thermal Ceramics, Augusta, Georgia

improved thermal insulation, improved electrical connections, and a back-up power supply system to run all four retrofitted test frames. Temperature gradients for new testing consisted of 700/100°C (5 tests) and 800/190°C (1 test) with initial loads of 200 psi (1380 kPa). Loading was performed under strain control utilizing a twelve-step loading scheme with loading every half hour at a rate of 5.56% strain/hour. Loading was followed by stress relaxation under constant strain with testing scheduled to be carried out for six-months (4,400 hours) and possibly extended to one-year (8,760 hours).

The initial 700/100°C gradient test was ended after running for only  $\approx$ 300 hours and relaxing to 138 psi (951 kPa), due to noise in the data with an unloading and load recovery test being performed on this sample before being ended. The 800/190°C gradient test was ended after nearly 2,150 hours due to a failure of the top heater platen. At the time the test lost temperature, the stress had relaxed to 108 psi (745 kPa). Upon cooling, the stress relaxed to 65 psi (448 kPa).

Efforts were attempted on tests that had met or nearly met the 4,400-hour time frame to simulate Transient Strain Events (TSE) using a four phase testing sequence. During Phase I the strain was raised to simulate shell cooling around the Min-K insulation material and then allowed to sit for approximately four days under fixed displacement. After sitting, Phase II was initiated by decreasing the strain under displacement control to simulate an expansion event. The sample was then held again under fixed displacement before starting Phase III during which data was collected on the creep rate. For Phase IV the strain was returned back to the original strain level and the test was put back in hold under fixed displacement.

TSE testing was unsuccessfully attempted on two tests under 700/100°C gradient conditions and 200 psi (1380 kPa) initial loading. The first test could not be completed due to a failure of the crosshead control system, but further stress relaxation testing under the fixed displacement was possible and was continued. This test was ended after over one year with over 9,250 hours of run-time due to a platen element failure and at its conclusion had relaxed to 119 psi (820 kPa). The second test had been running for over three months with over 3,460 hours of data collected and a relaxed stress of 108 psi (745 kPa) at the time of testing. This test resulted in the sample being overloaded due to a programming error after which, it was then decided to attempt an unloading of the specimen back to the original strain level. The test was then allowed to sit under fixed displacement and was continued until it was ended after running for 5,090 hours and had relaxed to 59 psi (407 kPa).

TSE testing was successfully performed on a test under 700/100°C gradient conditions and 200 psi (1380 kPa) initial loading which had been running for over 2,945 hours and had relaxed to 119 psi (820 kPa) at the time of testing. Following the TSE testing, the test was put back in hold under fixed displacement. At the time of the writing of this document this test was still running and had currently been running for over one year with over 10,050 hours of exposure and a current stress level of 105 psi (724 kPa). Even though the project is completed, this test will continue to run until platen or other frame failure occurs.

One test under 700/100°C gradient conditions and 200 psi (1380 kPa) initial loading has been running unaltered since its start. This test was still running at the time of the writing of this document and had been running for over one year with over 9,735 hours of exposure and a current stress level of 126 psi (869 kPa). Even though the project is completed, this test will continue to run until platen or other frame failure occurs.

In parallel to the above long-term gradient stress relaxation testing, three additional tests were started with the intent of obtaining data of one-year duration under a variety of temperature gradients ranging from 1100°F (593°C) down to room temperature and an initial load of 7812 lbf (155-158 psi, 1069-1089 kPa). Existing test frames were refurbished and retrofitted with modified heater platens, improved thermal insulation, improved electrical connections, and a back-up power supply system.

The three additional stress relaxation tests run on the refurbished modified mechanical test frames all reached one-year of test duration. The first test, with a gradient of 1100/300°F (593/149°C) and an initial loading of 7812 lbf (155 psi, 1069 kPa) had relaxed to 96 psi (662 kPa) at the one-year mark and at the time of the writing of this document, this test was still running with over 12,135 hours of duration. The second test, with a gradient of 1000/160°F (538/71°C) and an initial loading of 7812 lbf (158 psi, 1089 kPa) had relaxed to 115 psi (793 kPa) at the one-year mark and at the time of the writing of this document, this test was still running with over 12,070 hours of duration. The third test, with a gradient of 900/≈50°F and an initial loading of 7812 lbf (157 psi, 1082 kPa), had relaxed to 119 psi (820 kPa) at the one-year mark and at the time of the writing of this document, this test was still running with over 10,955 hours of duration. All tests will continue to run until platen or other frame failure occurs.

In support of the analysis of the mechanical testing results, other testing and evaluation of the Min-K material was performed. This testing and evaluation included measurement of elastic modulus and thermal conductivity, along with SEM/EDS analysis. One would expect the modulus to decrease with temperature, but since the sample was repeatedly being compressed, the modulus actually increased with subsequent testing at higher temperatures (up to 550°C). The modulus decreased as expected at 650°C. Thermal conductivity was found to range from 0.029 W/mK at 150°C up to 0.043 W/mK at 650°C. Through SEM/EDS analysis, the Min-K TE1400 was found to be composed of SiO<sub>2</sub> fibers in a SiO<sub>2</sub> matrix with small amounts of TiO<sub>2</sub>. As the samples were compressed, the fibers were bent or broken before being pulled out of the matrix leading to increased toughness of the material prior to failure.

Mathematical modeling was performed to describe the isothermal stress-relaxation of the Min-K material considering the instantaneous stress at time  $t$  and the initial stress at the onset of stress relaxation (at the end of mechanical loading) over a spectrum of relaxation times. It was assumed that the spectrum of relaxation times is logarithmically-distributed and that the temperature dependence of the model is described according to an Arrhenius relationship. To analyze the stress-relaxation behavior of a Min-K component subjected to a constant axial strain under a temperature gradient, the component was discretized in

isothermal sections and the stress-relaxation of each section will be described using the isothermal model

The concept of developing a closed-form solution was also investigated by considering the compressive stress, the original stress (either 100 or 200 psi/690 or 1380 kPa), along with test and relaxation times. Relaxation times were selected arbitrarily so that they would represent the time span over which the model needs to be applicable. Finite-element methods were also used to describe the stress-relaxation of the Min-K component using data from isothermal stress relaxation testing performed at temperatures between 850 and 190°C and the finite element program ANSYS.

During the long term gradient stress relaxation testing, data were fitted with an exponential model and compared with predictions made using isothermal stress relaxation data. Data were also fitted with the previously derived ORNL mathematical model, a Maxwell model, and a KWW model. These fits were updated weekly as new data became available to evaluate convergence of each model. Subsequent modeling with data in excess of one-year duration was also pursued. It was found that a simple log function ( $y = a - b * \log(x)$ ) best describes the long-term gradient stress relaxation data.

Also, the effect of fitting various time scales of data for predicting long term behavior was investigated. Fits were made using the same simple log function as above using data from 1,000, 2,500, 5,000, 7,500, and 9,000 hours. In each case, predictions were made out to 10,000 and 50,000 hours. From the current analysis, it appears that data between 5,000 and 7,500 hours is sufficient to predict behavior out to 10,000 hours. Data of less than 5,000 hours tends to under predict the stress relaxation. Data of greater than 7,500 hours accurately predicts the stress relaxation, but does not provide any improvement in the prediction. Therefore it may not be necessary to extend testing to this duration, even for predictions out to 50,000 hours.

## 2. Introduction

Characterization of the thermomechanical properties of Thermal Ceramics' Min-K 1400TE material, hereafter referred to as Min-K, was undertaken at Oak Ridge National Laboratory (ORNL) in support of its use for structural applications under a gradient temperature regime in an inert environment. In particular, ORNL sought to determine the high temperature compressive strength and stress relaxation behavior of Min-K up to 900°C in helium along with the formulation of a general model for the mechanical behavior exhibited by Min-K under these conditions. Testing consisted of general high temperature compressive mechanical testing, isothermal stress relaxation testing, and stress relaxation testing of samples exposed to a thermal gradient.

## 3. Room and High Temperature Compression Testing

### 3.1 Experimental Procedures

Initial compression testing was performed at room temperature at various loading rates ranging between 5 and 500 psi/hour ( $\approx 35$  and 3500 kPa/hour) to determine the effect of sample size and geometry on the compressive strength of Min-K. Testing was performed using the set-up shown in Figure 1, which consists of an electromechanical testing



machine (MTS Model 808) equipped with digital load and displacement controllers, computerized data acquisition, an alignment fixture, a 10 kN load cell, and a single zone furnace. A Plexiglas/aluminum environmental chamber with helium flow was used for creating a controlled environment. Testing was performed on three sample geometries shown in Figure 2.

The results from these initial tests indicated that there was no effect of sample geometry on the monotonic compressive strength of Min-K. Therefore, subsequent testing was performed on cylindrical specimens (Figure 2(a)). To determine the loading rates that would be used for stress relaxation testing, compression tests were next carried out using the experimental set-up depicted in Figure 1. Testing was performed at various loading rates under load or strain control utilizing constant and step loading functions (designated fast loading (200 psi/min, 1380 kN/min), nominal loading (5.56% strain/hour), and step loading (5.56% strain/hour) with the load was applied in discrete load steps). Sample loading was followed by stress relaxation under strain control. Examples of testing are shown in Figure 3. Test temperatures were 650, 850, and 900°C.

Additional high temperature compression testing was performed on cylindrical specimens (2" diameter, 3" length/5.1 cm diameter, 7.6 cm length) using the experimental set-up depicted in Figure 1. Samples were loaded in load control at a rate of 53 psi/hour (365 kN/hour) in three load steps of 50, 100 and 200 psi (345, 690, and 1380 kPa) with quick unload/load cycles between steps. Loading was followed by a hold period in load control (3 to 100 hours) to allow for sample creep. Testing was carried out at 190, 382, 813, and 850°C.

### 3.2 Results

Results from initial compression testing of various sample sizes and geometries are presented in Appendix 1. The key finding from these tests was that the results were independent of sample geometry. Therefore, cylindrical samples were selected for subsequent mechanical testing because of their ease of fabrication and the simplified data analysis as compared to the hourglass sample geometries. Additionally, it was found that the data obtained using the cylindrical geometry samples were comparable to those obtained with the two hourglass geometries after correction for effects of these geometries was made (i.e. correction for neck portions of samples and non-uniform cross section of samples). This is shown in Figure 4.

Results from preliminary high temperature compression testing are shown in Figure 5. The key result from these tests was the determination of loading schemes for subsequent stress relaxation testing and high temperature compression testing. It was determined that stress relaxation samples would be loaded in strain control utilizing a twelve-step loading scheme with loading every half hour at a rate of 5.56% strain/hour. High temperature compression samples would be loaded in load control at a rate of 53 psi/hour (365 kPa/hour) followed by a designated hold in load control of 3 to 100 hours to allow for sample creep.

High temperature compression testing was completed. Typical results from testing are presented in Figure 6. The strain was found to recover to its previous level after quick unloading/loading events at 50, 100, and 200 psi (345, 690, and 1380 kPa). The hold step after achieving load successfully exhibited expected creep behavior, which increased with test temperature. Additional tests at original test temperatures verified repeatability of test results.

#### 4. Isothermal Stress Relaxation Testing

##### 4.1 Experimental Procedures

Isothermal stress relaxation testing was performed at various temperatures and loads as indicated in Table 1 (Soaked Sequence) using 6" (15 cm) diameter, 2" (5 cm) long cylindrical samples. Testing was performed using the set-up shown in Figure 7, which consists of an electromechanical testing machine (Instron Model 1380) equipped with load and displacement analog controllers, an external LVDT for feedback displacement control, a 35 kN load cell, and a single zone furnace. An aluminum environmental chamber with helium flow (99.999% purity, flow rate of 70 mm) was used for creating a controlled environment. Loading was performed in strain control utilizing a twelve-step loading scheme with loading every half hour at a rate of 5.56% strain/hour as requested by the program sponsor to simulate actual system parameters. Loading was then followed by stress relaxation under constant strain and the duration of the test was determined when the initial load was dissipated or had leveled off to a rate of change less than 0.25 psi/hour (1.7 kPa/hour).

After completion of the original isothermal stress relaxation testing, additional testing was undertaken. A temperature creep sweep test was performed on cylindrical specimens (2" diameter, 3" length/5.1 cm diameter, 7.6 cm length) using the experimental set-up depicted in Figure 1. This testing was undertaken to identify potential changes in creep mechanisms at temperatures between the upper test temperatures (850 and 813°C) and the lower test temperatures (382 and 190°C). Following completion of the temperature creep sweep test, additional isothermal stress relaxation testing was completed at 550 and 650°C with maximum stresses of 100 and 200 psi (690, and 1380 kPa).

##### 4.2 Results

Experimental testing of Min-K under isothermal stress relaxation conditions was completed at 190, 382, 813, and 850°C with maximum initial stresses of 100 and 200 psi (690, and 1380 kPa). The duration of these tests spanned between 24 and 400 hours (plots shown in Appendix 2). Typical results from isothermal stress relaxation testing are shown in Figure 8. The data revealed different stress relaxation behavior for each temperature regime (high – above 800°C and low – below 400°C). This difference in behavior necessitated additional isothermal testing at 550 and 650°C and an initial stress of 200 psi (1380 kPa) with testing lasting as long as 2,600 hours (plots shown in Appendix 2).

#### 5. Gradient Stress Relaxation Testing

##### 5.1 Experimental Procedures

Gradient stress relaxation testing was intended to be performed at various temperatures and loads as indicated in Table 1 (Gradient Sequence) using 6" (15 cm) diameter, 3" (7.5

cm) long cylindrical samples. Testing was performed using the set-up shown in Figure 9, which consists of an electromechanical testing machine (Instron Model 1380) equipped with load and displacement digital controllers, a 35 kN load cell, a heated Inconel platen above the sample, and a single zone furnace. An aluminum environmental chamber with helium flow (99.999% purity, flow rate of 70 mm) was used for creating a controlled environment. Loading was performed under strain control utilizing a twelve-step loading scheme with loading every half hour at a rate of 5.56% strain/hour. Loading was followed by stress relaxation in strain control with testing carried out until the initial load was dissipated or had leveled off to a rate of change of less than 0.25 psi/hour (1.7 kPa/hour) (up to 2000 hours).

Following completion of the initial isothermal and gradient stress relaxation testing, an effort was undertaken to convert two experimental set-ups for isothermal stress relaxation into set-ups for gradient stress relaxation and to improve the robustness of the gradient stress relaxation testing in an effort to complete tests of six-month to one-year duration. To facilitate this, the test frames were retrofitted with new heater platens, improved thermal insulation, improved electrical connections, and a back-up power supply system to run all four retrofitted test frames. The back-up power supply system (208 VAC, 3 PH, 4 W, 60 Hz, 111A, 120 cells) is shown in Figure 10.

Gradient stress relaxation testing was performed using 6" (15 cm) diameter, 3" (7.5 cm) long cylindrical samples. Temperature gradients for new testing consisted of 700/100°C (5 tests) and 800/190°C (1 test) with initial loads of 200 psi (1380 kPa). A modified test procedure was implemented, based on the previous gradient stress relaxation test procedure and testing was performed using a set-up similar to that shown in Figure 9. This set-up consists of an electromechanical testing machine (Instron Model 1380) equipped with load and displacement digital controllers, a 35 kN load cell, a heated Inconel platen above and below the sample, and a single zone furnace. An aluminum environmental chamber with helium flow (99.999% purity, flow rate of 70 mm) was used for creating a controlled environment.

Loading was performed under strain control utilizing a twelve-step loading scheme with loading every half hour at a rate of 5.56% strain/hour. Loading was followed by stress relaxation under constant strain with testing scheduled to be carried out for six-months (4,400 hours) and possibly extended to one-year (8,760 hours). Transient Strain Events (TSE) expected during actual material service were simulated using test specimens that had undergone stress relaxation testing in excess of 4,400 hours. These efforts involved four phases of testing. During Phase I of this testing, the strain was raised under displacement control to simulate shell cooling around the Min-K insulation material. The test was then allowed to sit for approximately four days under fixed displacement. After sitting, Phase II was initiated by decreasing the strain under displacement control to simulate an expansion event. The sample was then held again under fixed displacement for thirty minutes. Phase III consisted of switching to load control and holding the existing stress level for one hour to collect data on the creep rate of the material given the post test stress level. Following the hold, the system was switched back to displacement control and Phase IV was started. For this phase, the strain was returned back to the

original strain level prior to TSE testing. Following Phase IV, the test was put back under fixed displacement.

In parallel to the above long-term gradient stress relaxation testing, three additional tests were started with the intent of obtaining data of one-year duration (8,760 hours) under a variety of temperature gradients. Existing test frames were refurbished and retrofitted with modified heater platens, improved thermal insulation, improved electrical connections, and a back-up power supply system similar to that described above. Gradient stress relaxation testing was performed using 8" (20 cm) diameter, 1.856" (4.7 cm) thick right circular cylindrical samples. Temperature gradients for testing ranged from 1,100°F (593°C) down to room temperature with the gradients shown in Table 2. All samples were subjected to an initial load of 7812 lbf (155-158 psi, 1069-1089 kPa). A modified test procedure was written, based on previous gradient stress relaxation test procedures and testing was performed using a set-up similar to the one shown in Figure 9. A picture of a modified test frame used for this testing is shown in Figure 11.

Test frames were individually modified to accommodate physical attributes of the retrofitted frames. In general, this set-up consists of an electromechanical testing machine (rebuilt by Instrumet) equipped with load and displacement digital controllers run by MTS Test Works, a 10,000 lb. (44.5 kN) Sensotec Model 41 load cell, a heated metallic platen above and below the sample (304 stainless steel top, S-7 tool steel bottom), and an insulated refractory box surrounding the sample/heated platen assembly. An aluminum environmental chamber with helium flow (99.999% purity, flow rate of 70 mm) was used to create a controlled environment. Loading was performed in strain control at a rate of 0.4 mm/minute. Loading was followed by stress relaxation under constant strain with testing scheduled to be carried out for one-year (8,760 hours).

Additional test specimens for gradient testing were obtained and an effort was made to trace current and previous test specimens to specific batches supplied by Thermal Ceramics. An effort was also made to correlate specimen densities to specific test results. As far as could be determined, the corresponding sample densities, batch designations and test numbers are shown in Appendix 3.

## 5.2 Results

Initial gradient stress relaxation testing was completed, although under slightly different thermal conditions than the originally proposed 850/450°C and 450/190°C with a maximum initial stress of 100 and 200 psi (690, and 1380 kPa). The duration of these tests spanned between 100 and 1300 hours. The temperatures of the isothermal stress relaxation tests were selected under the assumption that the creep deformation of Min-K, and consequently, its stress-relaxation behavior up to 850°C is a thermally-activated process with a well-defined activation energy. The temperatures for the gradient stress relaxation tests were selected to cover the entire temperature range explored in the isothermal testing. Actual test temperatures were dictated by the capabilities of the test system.

Typical results from the initial gradient relaxation testing are shown in Figure 12 for the temperature gradient of 850/275°C and initial stress of 200 psi (1380 kPa).

Additional gradient stress relaxation test results using the original frames are discussed below. The initial 700/100°C gradient test (Gradient Test #9) was ended after running for only  $\approx$ 300 hours and relaxing to 138 psi (951 kPa), due to noise in the data cause by poor tuning of the controller. At the conclusion of this test, an unloading study was performed by removing 1.3% strain over a one hour period. This was followed by a 2 hour hold under constant displacement. The unloading event resulted in a reduction in stress of  $\approx$ 62 psi (427 kPa) and the hold period resulted in a recovery of  $\approx$ 2 psi (14 kPa). The results of this test are shown in Figure 13. Following the retuning of the displacement controller, a new 700/100°C gradient test (Gradient Test #10) was started on the frame.

Test #8 was run under an 800/190°C gradient and was ended after nearly 2,150 hours due to a failure of the top heater platen. An unloading study could not be run on this test due to the loss of temperature and corresponding stress on the sample. At the time the test lost temperature, the stress had relaxed to 108 psi (745 kPa). Upon cooling, the stress relaxed to 65 psi (448). The results of this test are shown in Figure 14. Following replacement of the top platen, a new 700/100°C gradient test (Gradient Test #13) was started on the frame.

Upon completion of the conversion of the two isothermal test configurations to gradient test configurations and the connecting of these frames to the back-up power supply, testing was initiated on these frames. On the first frame, a 700/100°C gradient test was started (Gradient Test #11). On the second frame, a short-term loading test was performed over a one week period to evaluate the effects of preloading a specimen to 180 psi (1241 kPa) and then heating it to a gradient condition of 700/100°C to mimic the actual loading conditions of the Min-K component in service. Following the heating over a twenty-four hour period, the sample was allowed to soak at temperature for thirteen hours while stress relaxation occurred. The sample was then cooled over a six and a half hour period, after which the stress was removed by removing the accumulated strain over a two hour period. Results of this testing are shown in Figure 15. Following completion of the short-term loading test, a 700/100°C gradient test (Gradient Test #15) was started on the second frame.

TSE testing was attempted on Test #10, but could not be completed due to a stuck crosshead discussed earlier. Stress relaxation testing under the fixed displacement was possible and was continued. This test was ended after over 9,250 hours due to a platen element failure. At its conclusion, this test had been running for over one year and had relaxed to 119 psi (820 kPa). Results for this test are shown in Figure 16.

TSE testing was attempted on Test #11. At the time of testing, this test had accumulated over 3,460 hours and had relaxed to 108 psi (745 kPa). This test was not successful and resulted in the sample being overloaded as discussed previously. It was then decided to attempt an unloading of the specimen back to the original strain level. During this unloading nearly the entire load was removed and the unloading was stopped with

approximately 25 psi (172 kPa) remaining on the specimen. The test was then allowed to sit under fixed displacement after these events. The test was continued until being ended after running for 5,090 hours and had relaxed to 59 psi (407 kPa). Results for this test are shown in Figure 17.

TSE testing was performed on Test #13. At the time of testing, this test had been running for over 2,945 hours and had relaxed to 119 psi (820 kPa). Phase I of the testing was successfully completed, raising the strain from 11.493% to 11.953% and the stress from 119 psi (820 kPa) to 137 psi (945 kPa). The test was then allowed to sit for approximately four days under fixed displacement. After sitting, the sample had relaxed to a stress of 135 psi (931 kPa). Following this hold, Phase II was initiated by decreasing the strain from 11.953% to 11.320% at a rate of 1.52%/hour. This resulted in a loss of stress from approximately 135 psi (931 kPa) to roughly 110 psi (758 kPa). The sample was then held again under fixed displacement for thirty minutes. Phase III consisted of switching to load control and holding the existing stress level for one hour. During this time, no measurable change in the strain level was seen. Following the hold, the system was switched back to displacement control and Phase IV was started. For this phase, the strain was returned from 11.320% back to the original strain level of 11.493%. This resulted in a change of stress from approximately 110 psi (758 kPa) to 118 psi (814 kPa). Following Phase IV, the test was put back in hold under fixed displacement. At the time of the writing of this document this test was still running. The test has currently been running for over one year with over 10,050 hours of exposure and a current level of 105 psi (724 kPa). Results to date for this test are shown in Figure 18. Even though the project is completed, this test will continue to run until platen or other frame failure occurs.

Test #15 has been running unaltered since its start. . The test has been running for over one year with over 9,735 hours of exposure and a current level of 126 psi (869 kPa) at the time of the writing of this document. Results to date for this test are shown in Figure 19. Even though the project is completed, this test will continue to run until platen or other frame failure occurs.

The three additional stress relaxation tests run on the refurbished, modified mechanical test frames all reached one-year of test duration. The first test, with a gradient of 1,100/300°F (593/149°C) and an initial loading of 7,812 lbf (155 psi, 1067 kPa) had relaxed to 96 psi (662 kPa) at the one-year mark as shown in Figure 20. At the time of the writing of this document, this test was still running with over 12,135 hours of duration and will continue to run until platen or other frame failure occurs.

The second test, with a gradient of 1,000/160°F (538/71°C) and an initial loading of 7,812 lbf (158 psi, 1089 kPa) had relaxed to 115 psi (793 kPa) at the one-year mark as shown in Figure 21. At the time of the writing of this document, this test was still running with over 12,070 hours of duration and will continue to run until platen or other frame failure occurs.

The third test, with a gradient of 900/≈50°F (482/≈10°C) and an initial loading of 7,812 lbf (157 psi, 1082 kPa), had relaxed to 119 psi (820 kPa) at the one-year mark as shown

in Figure 22. At the time of the writing of this document, this test was still running with over 10,955 hours of duration and will continue to run until platen or other frame failure occurs.

Even though this gradient testing was initially scheduled to run for one-year (8,760 hours), efforts will be continued until platen failure or termination by the project sponsors. Additionally, mathematical modeling of the Min-K stress relaxation behavior under the various temperature gradients is being pursued.

## 6. Additional Testing and Evaluation

### 6.1 Experimental Procedures

In support of the analysis of the mechanical testing results, other testing and evaluation of the Min-K material was performed. This testing and evaluation included measurement of elastic modulus and thermal conductivity, along with SEM/EDS analysis. Elastic modulus was measured from room temperature up to 650°C by repeatedly compressing a test sample to 1% strain using the test frame shown in Figure 1. Measurements were made at room temperature, 190, 382, 550, and 650°C. Thermal conductivity was determined by the laser flash technique according to ASTM E1461<sup>3</sup>. SEM/EDS analysis was performed using a Hitachi 4700 SEM/EDS.

### 6.2 Results

Results from the elastic modulus testing are shown in Figure 23. One would expect the modulus to decrease with temperature, but since the sample was repeatedly being compressed, the modulus was actually seen to increase with subsequent testing at higher temperatures (up to 550°C). The modulus was seen to decrease as expected at 650°C. Measure elastic modulus vales are shown in Table 3.

Results from thermal conductivity testing are shown in Figure 24. Conductivity was found to range from 0.029 W/mK at 150°C up to 0.043 W/mK at 650°C. These results are shown in relation to data for air, another thermal insulation product (designated HD) and Min-K TE1800.

A characteristic result from the SEM/EDS analysis is shown in Figure 25. The Min-K TE1400 was found to be composed of compressed SiO<sub>2</sub> fibers in a SiO<sub>2</sub> matrix with small amounts of TiO<sub>2</sub>. As the samples were compressed, the fibers were bent or broken before being pulled out of the matrix leading to increased toughness of the material prior to failure.

## 7. Modeling

The applicability of the following model to describe the isothermal stress-relaxation of Min-K was investigated:

---

<sup>3</sup> “Standard Test Method for Thermal Diffusivity of Solids by the Flash Method,” ASTM E 1461, Annual Book of ASTM Standards Vol. 14.02, American Society for Testing and Materials, West Conshohocken, PA, 1998.

$$\frac{\sigma}{\sigma_0} = \sum_{i=1}^n a_i e^{-\frac{t}{t_i}} \quad (1)$$

In this model,  $\sigma$  is the instantaneous stress at time  $t$ ,  $\sigma_0$  is the initial stress at the onset of stress relaxation (at the end of mechanical loading),  $a_i$  are temperature-dependent constants and  $t_i$  constitute a spectrum of relaxation times. It was assumed that the spectrum of relaxation times is logarithmically-distributed and that the temperature dependence of  $a_i$  is described according to an Arrhenius relationship.

To analyze the stress-relaxation behavior of a Min-K component subjected to a constant axial strain under a temperature gradient, the component was discretized in isothermal sections and the stress-relaxation of each section will be described using Equation 1 as shown in Figure 26.

The concept of developing a closed-form solution was also investigated, along with using finite-element methods to describe the stress-relaxation of the Min-K component. Model formulation was initially performed based on all collected isothermal data. The stress relaxation of Min-K at temperatures between 190°C and 850°C was described by the following equation:

$$\frac{\sigma(t)}{\sigma_0} = a_1 e^{-\frac{t}{t_1}} + a_2 e^{-\frac{t}{t_2}} \quad (2)$$

where  $\sigma$  is the compressive stress,  $\sigma_0$  is the original stress (either 100 or 200 psi),  $t$  is time,  $a_1$  and  $a_2$  are temperature-dependent parameters and  $t_1$  and  $t_2$  are the relaxation times of the material. Relaxation times were selected arbitrarily so that they would represent the time span over which the model needs to be applicable.

After fitting this model to experimental data, it was found that the constants  $a_i$  and  $t_i$  could be expressed as follows, where  $T$  is temperature in °C:

$a_1$	$0.053 + 7.6 \times 10^{-10} T^3$
$a_2$	$0.88 - \left(\frac{T}{880}\right)^4$
$t_1$	10 hours
$t_2$	10,000 hours

Data from isothermal stress relaxation testing performed at temperatures between 850 and 190°C was incorporated into the finite element program ANSYS to model the relaxation behavior of Min-K. It was found that the data at each test temperature could be



modeled by using the time hardening creep equation. The form of this model used by ANSYS is:

$$\dot{\varepsilon}_{cr} = a\sigma^b t^c e^{\frac{-d}{T}} \quad (3)$$

where  $\dot{\varepsilon}_{cr}$  is the change in creep strain with respect to time,  $\sigma$  is equivalent stress,  $t$  is time,  $T$  is temperature, and  $a$ ,  $b$ ,  $c$ , and  $d$  are temperature dependent parameters.

Initial analyses were performed for several isothermal cases to verify the creep model. The material model in ANSYS was applied to a finite element model consisting of 400 axisymmetric elements and 441 nodes. A cylinder with a radius and height of 3" (7.5 cm) was modeled in ANSYS with the axisymmetric elements. The results of these analyses showed good agreement with test data. Figure 27 shows the comparison between the finite element analysis (FEA) and the test results 190°C, 650°C, and 850°C.

After the applicability of the creep model was verified for the isothermal case at different temperatures, the model was used to analyze the case when a temperature gradient is applied to the test specimen. Initial analyses were performed for the case of a uniform gradient along the main axis of the model. The results of this analysis predicted much more stress relaxation than what had been determined experimentally. A temperature gradient more closely matching the actual test temperature distribution during a temperature gradient stress relaxation test was used to repeat the analysis. Figure 28 shows the temperature distribution obtained experimentally along with that predicted by ANSYS through interpolation.

At the center of the test specimen the axial temperature gradient is uniform but temperatures away from the center of the test specimen approach the outside temperature of the furnace. The results from the thermal FEA model were used as input for the structural model in ANSYS and it was found that the predicted stress relaxation did fit the experimental results much more closely. Figure 29 shows a comparison between the stress predicted by the model and the experimental results for a temperature gradient test under 200 psi (1380 kPa) at temperatures between 850°C and 275°C.

The proposed closed-form solution was found to be described by the equation:

$$m1\text{Exp}(-t/10)+m2\text{Exp}(-t/200)+m3\text{EXP}(-t/10000) \quad (4)$$

where: (for  $T > 382^\circ\text{C}$ )

$$m1 = 0.0011T - 0.34$$

$$m2 = 1.09\text{E}-8T^3 - 2.4\text{E}-5T^2 + 0.0176T - 3.7$$

$$m3 = 2.8\text{E}-6T^2 - 0.0053T + 2.482$$

(for  $T \leq 382^\circ\text{C}$ )

$$m1 = 0.08$$

$$m2 = 0.014$$

$$m3 = 0.86$$

Examples of test data fit with this equation are shown in Figure 30.

During the long term gradient stress relaxation testing, a log-log model was fitted to the data and to previous predictions made using isothermal stress relaxation data. Data was also fit to the previously derived ORNL mathematical model, a Maxwell model, and a KWW model. These fits were updated weekly as new data became available to evaluate convergence of each model. Examples for Gradient Stress Relaxation Tests #10 and #11 mid-way through the intended one-year test duration are shown in Figure 31.

Subsequent modeling with data in excess of one-year duration was also pursued. It was found that a simple log function ( $y = a - b * \log(x)$ ) was sufficient to fit this long-term gradient stress relaxation data as shown in Figure 32 for Test #13 and Test #15. In both cases, an R value of 0.98 was obtained using this function.

Also, the effect of fitting various time scales of data for predicting long term behavior was investigated. Fits were made using the same simple log function as above using data from 1,000, 2,500, 5,000, 7,500, and 9,000 hours. In each case, predictions were made out to 10,000 and 50,000 hours as shown in Figure 33 and Figure 34, respectively.

From the current analysis, it appears that data between 5,000 and 7,500 hours is sufficient to predict behavior out to 10,000 hours. Data of less than 5,000 hours tends to under predict the stress relaxation. Data of greater than 7,500 hours accurately predicts the stress relaxation, but does not provide any improvement in the prediction. Therefore, assuming that the process responsible for the creep/stress relaxation behavior exhibited is smooth and continuous, it may not be necessary to extend testing to this duration, even for predictions out to 50,000 hours.

## 8. Lessons Learned

- Sample geometry was found to not impact the monotonic compressive strength of the Min-K material. Therefore, subsequent testing was performed on cylindrical specimens.
- Methods of platen construction were refined through the project to produce heated platens capable of 900°C and continuous operation in excess of one year (8,760 hour) duration. Final platen construction utilized Inconel and various steels for the platen body, dependent on temperatures, and nichrome resistive heaters encased in ceramic insulation<sup>4</sup>.
- For long-term testing, such as that undertaken in this project, a back-up power supply system should be utilized.
- Isothermal stress-relaxation data revealed different stress relaxation behavior for varying temperature regimes defined as high – above 800°C and low – below 400°C.
- The Min-K Te1400 was found to be composed of SiO<sub>2</sub> fibers in a SiO<sub>2</sub> matrix with small amounts of TiO<sub>2</sub>. As the samples were compressed, the fibers were bent or broken before being pulled out of the matrix leading to increased toughness of the material prior to failure.

---

<sup>4</sup> International Ceramics & Heating Systems, Inc., Circleville, New York

- Isothermal stress-relaxation of the Min-K material was successfully modeled by considering the instantaneous stress at time  $t$  and the initial stress at the onset of stress relaxation (at the end of mechanical loading) over a spectrum of relaxation times (assuming the spectrum of relaxation times is logarithmically-distributed and the temperature dependence of the model is described according to an Arrhenius relationship). The stress-relaxation behavior of a Min-K component subjected to a constant axial strain under a temperature gradient was estimated by analyzing the component discretized in isothermal sections and the stress-relaxation of each section described using the isothermal model.
- A closed-form solution was successfully derived by considering the compressive stress, the original stress, and test and relaxation times. Relaxation times were selected arbitrarily so that they would represent the time span over which the model needs to be applicable. Finite-element methods were also successfully used to describe the stress-relaxation of the Min-K component using data from isothermal stress-relaxation testing and the finite element program ANSYS.
- Data from testing were fitted throughout the test lives with the derived ORNL mathematical model, a Maxwell model, and a KWW model. Subsequent modeling with data in excess of one-year duration was also pursued. It was found that a simple log function ( $y = a - b * \log(x)$ ) best describes the long-term gradient stress relaxation data.
- Fits of the test data were made using a same simple log function and data from 1,000, 2,500, 5,000, 7,500, and 9,000 hours. In each case, predictions were made out to 10,000 and 50,000 hours. From the current analysis, it appears that data between 5,000 and 7,500 hours is sufficient to predict behavior out to 10,000 hours. Data of less than 5,000 hours tends to under predict the stress relaxation. Data of greater than 7,500 hours accurately predicts the stress relaxation, but does not provide any improvement in the prediction. Therefore it may not be necessary to extend testing to this duration, even for predictions out to 50,000 hours.

## 9. Acknowledgements

The authors acknowledge the work of ORNL Technical Interns Eric Loveland and Andre Prigmore who contributed to the set-up and maintaining of the long-term testing. Contributions were also made by Laura Riester (ORNL) who provided testing support. Technical advisement and input was also provided by Al Lewis, Michael Lauer, and Nora Low (United Technologies) and Dave Svrjcek (Teledyne Energy Systems, Inc.). The authors would also like to thank Jy-An John Wang for reviewing the manuscript.



Tables and Figures

Table 1. Stress Relaxation Test Matrix

(note: 100 psi = 690 kPa, 200 psi = 1380 kPa)

Temp C	Temp Profile @ 50psi		Temp Profile @ 200psi	
	Gradient Sequence	Soaked Sequence	Gradient Sequence	Soaked Sequence
190	4 (450*/190C)	12,16	2 (450*/190)	10,15
382	-	11,14	-	9,13
813	-	7,8	-	5,6
850	3 (850/450*)	3,4	1 (850/450*)	1,2

Table 2. Additional Long-Term Gradient Stress Relaxation Testing Matrix

Hot Side Temperature	Cold Side Temperature	Initial Load
900°F (482°C)	RT	7,812 lbf (1069 kPa)
1,000°F (538°C)	160°F (71°C)	7,812 lbf (1089 kPa)
1,100°F (593°C)	300°F (149°C)	7,812 lbf (1082 kPa)

Table 3. Elastic Modulus Values for Min-K TE1400 Under 1% Strain at Increasing Temperatures

Temperature (°C)	Modulus (x 10 <sup>4</sup> psi)	R <sup>2</sup>
Room Temperature	11.73	0.9915
190	12.65	0.9803
382	14.30	0.9820
550	14.95	0.9919
650	12.05	0.7823

(1 psi = 6.89 kPa)

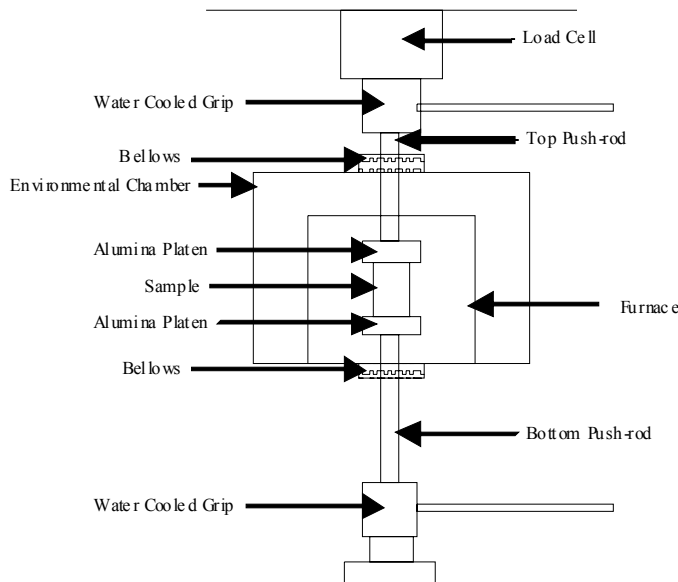

Figure 1. Experimental set-up for determination of compressive strength of Min-K

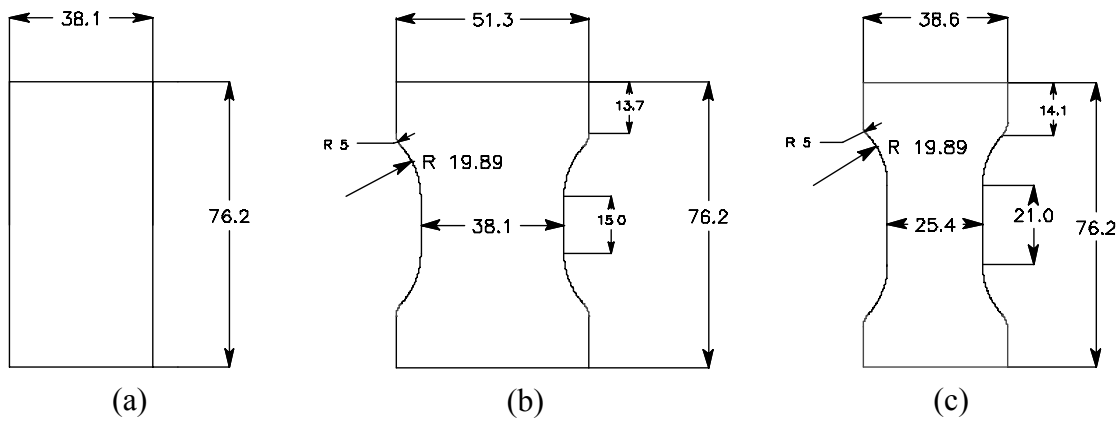

Figure 2. Sample Geometries for Initial Compression Testing (dimensions in mm)

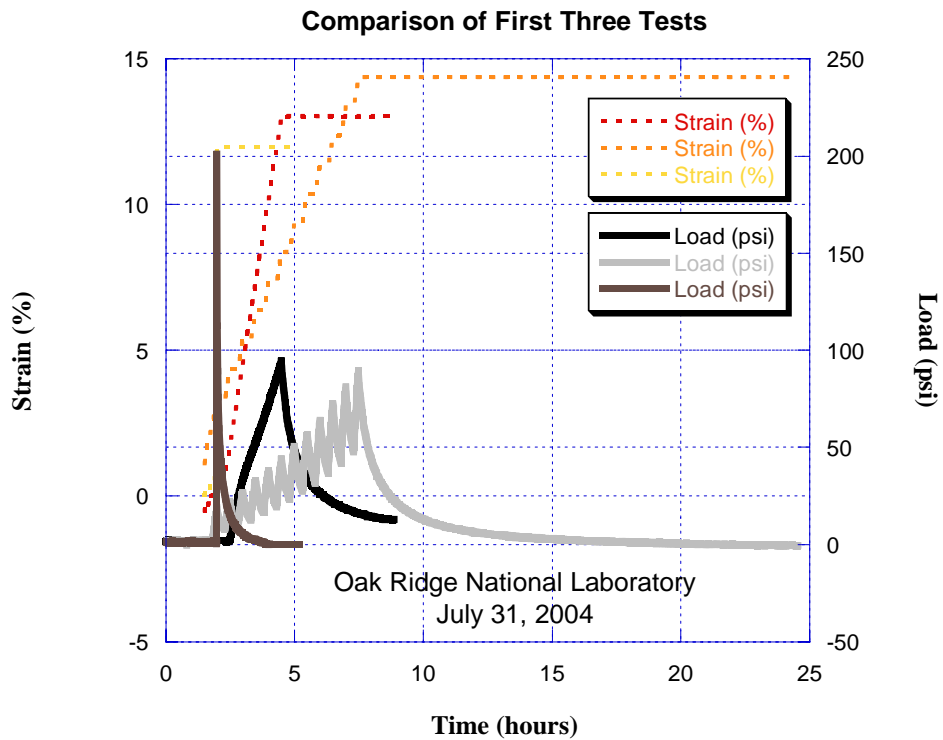
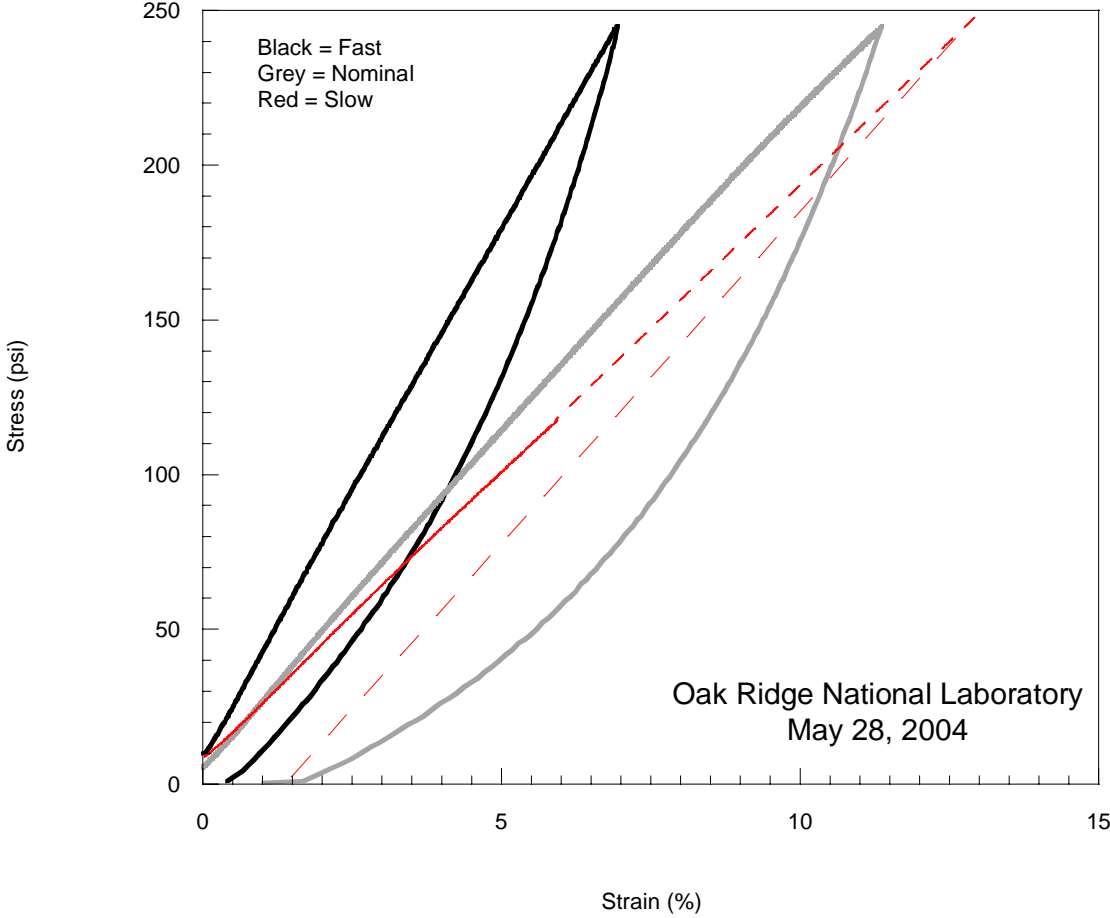
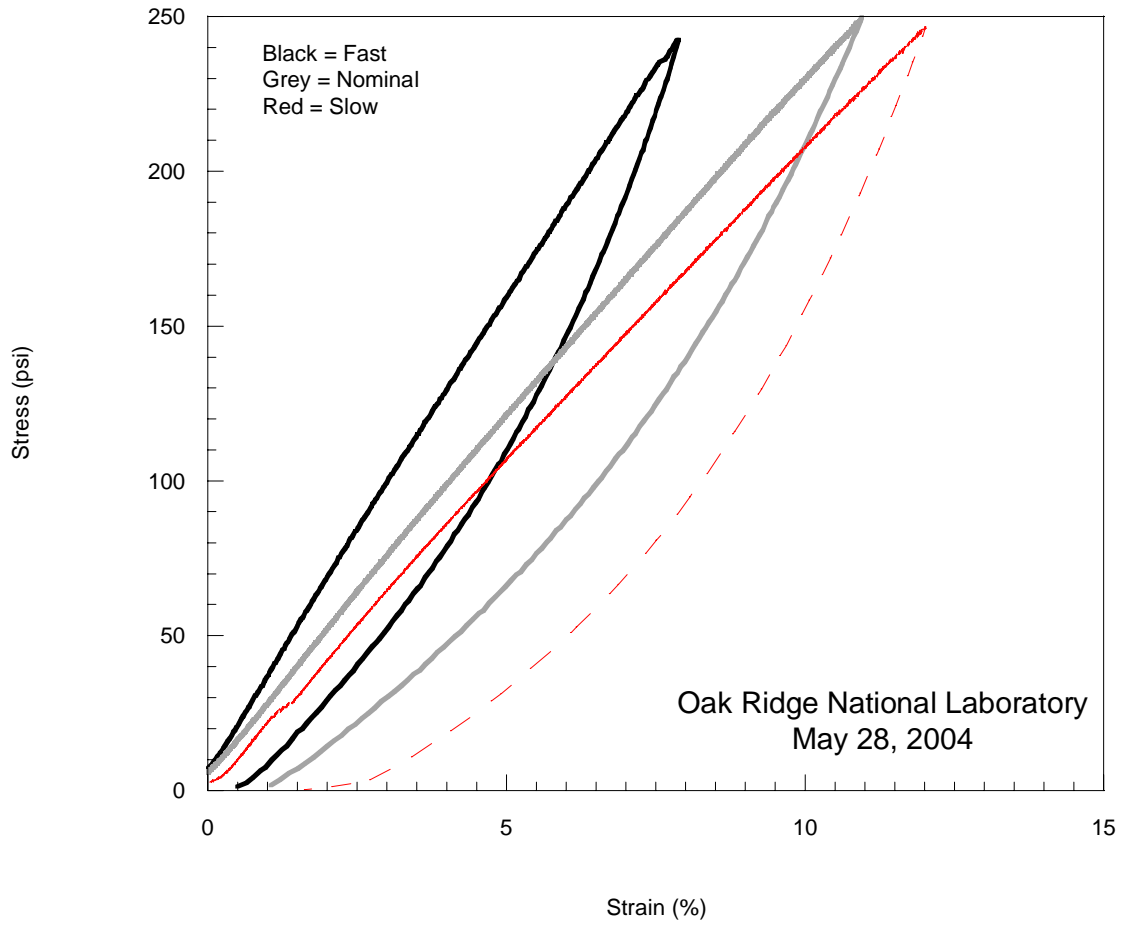

Figure 3. Loading and Relaxation Schemes for Preliminary High Temperature Compression Testing (black – nominal loading, grey – step loading, brown – fast loading)

### Load Rate Test for 2'(a) Geometry



### Load Rate Testing for 2'(b) Geometry





### Cylindrical Load Rate Testing

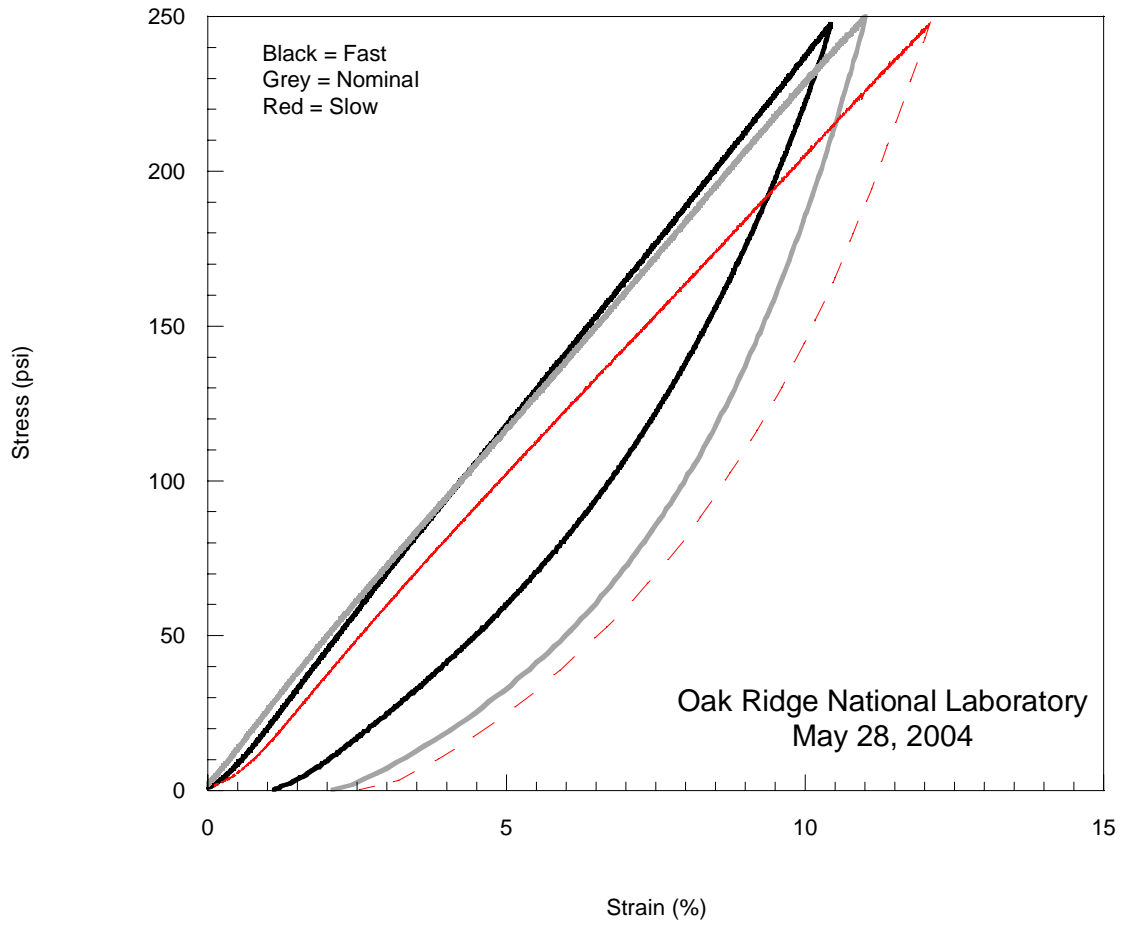
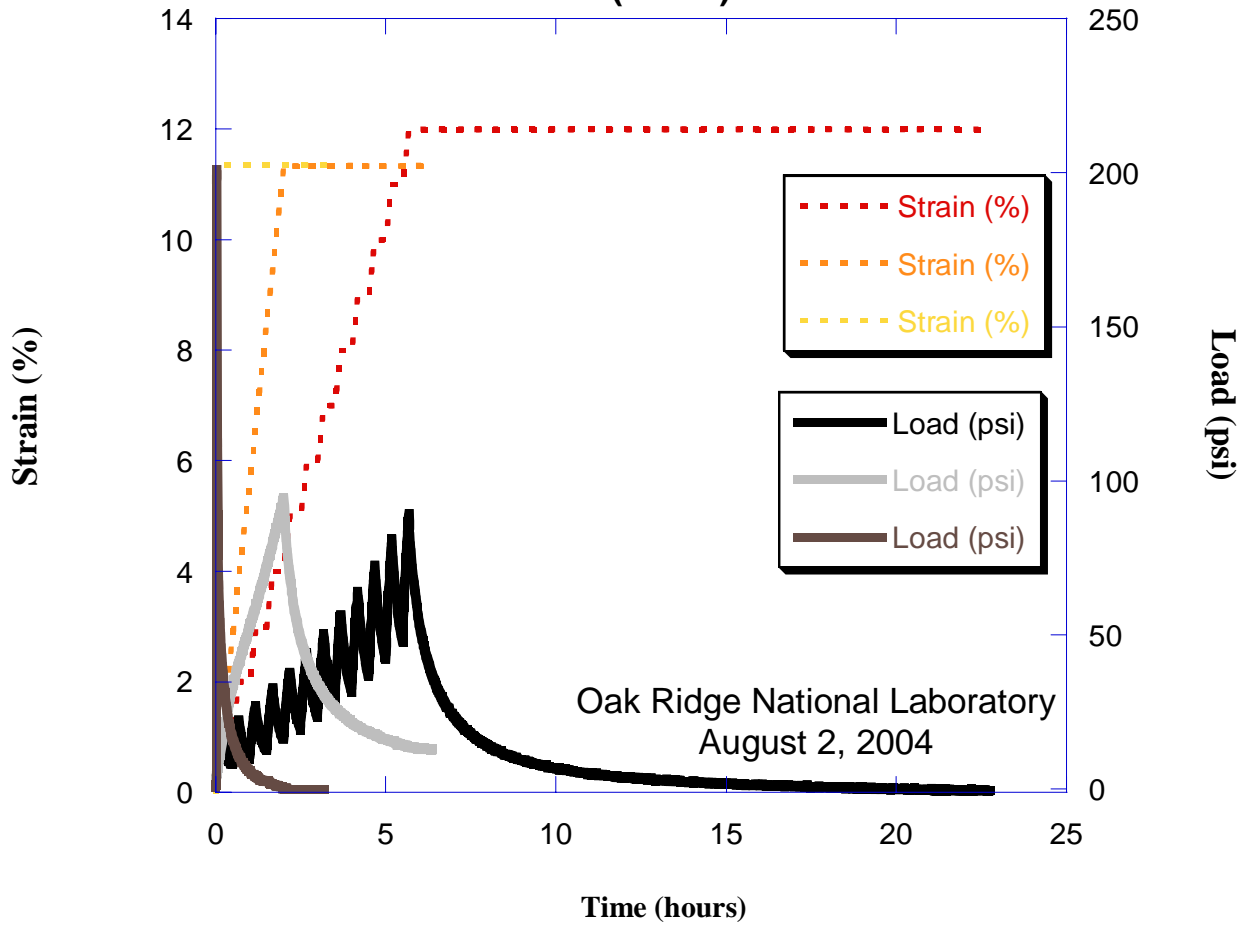
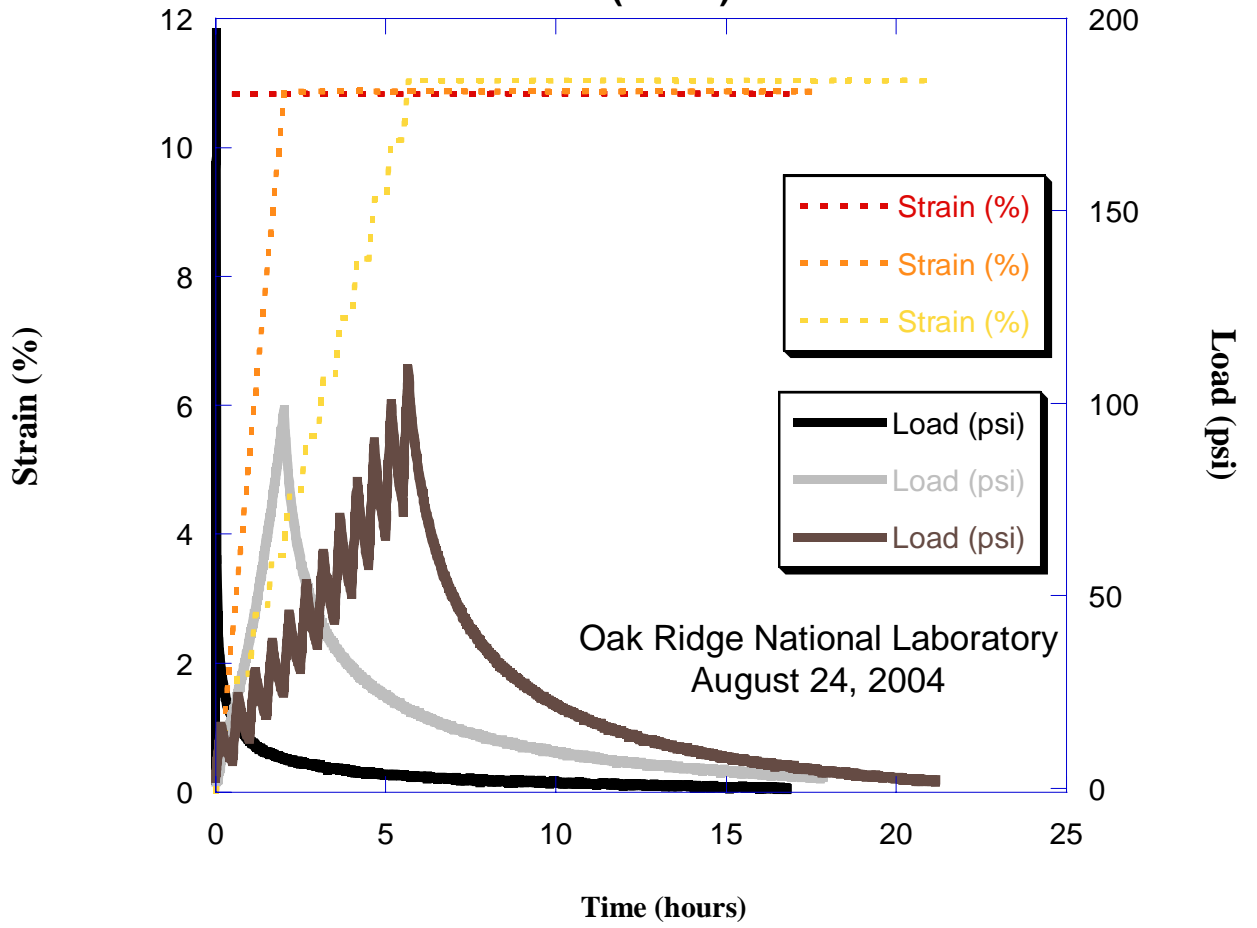

Figure 4. Results of Initial Compression Testing

### Comparison of First Three Tests (900°C)



### Comparison of Three Tests (850°C)



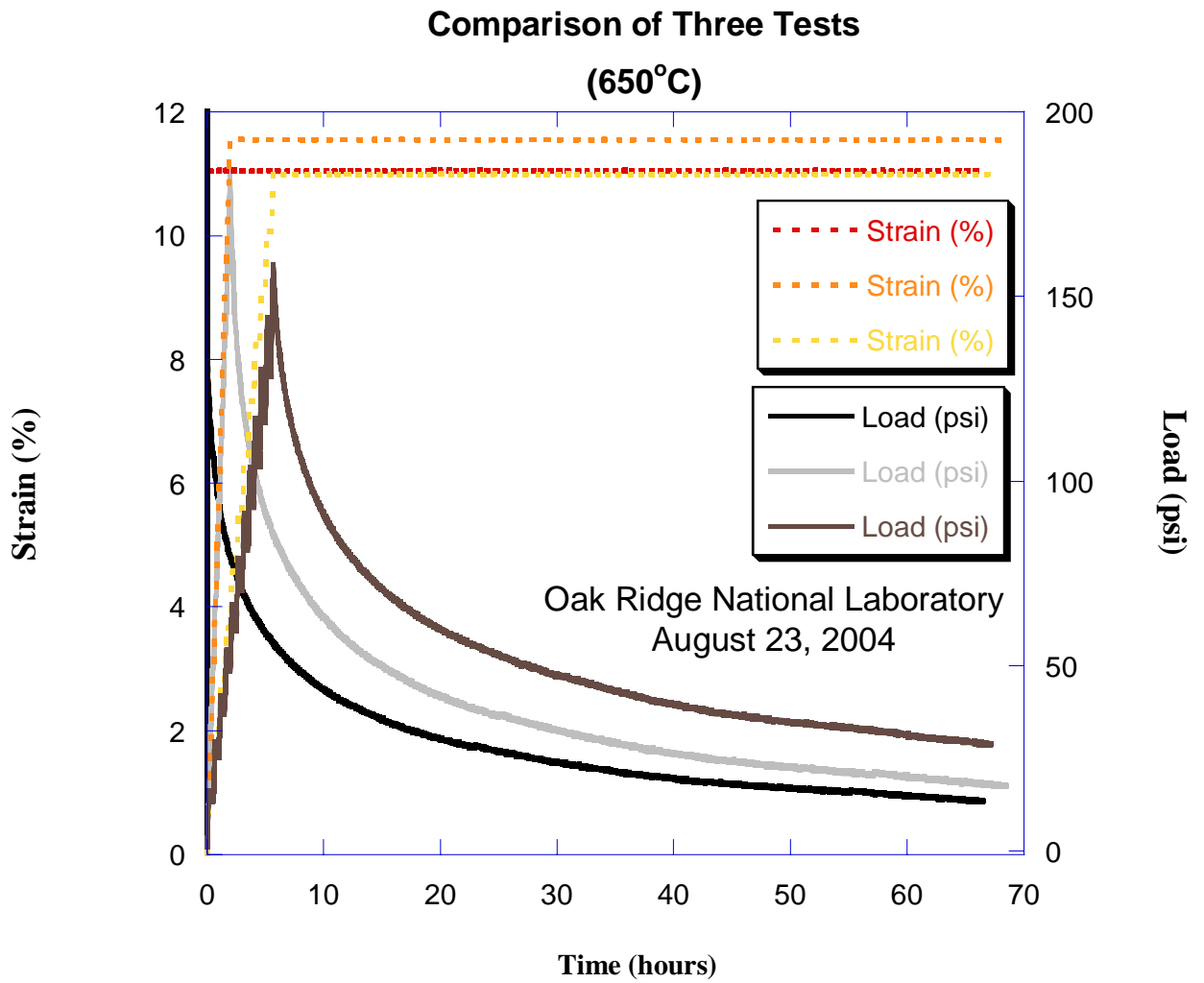
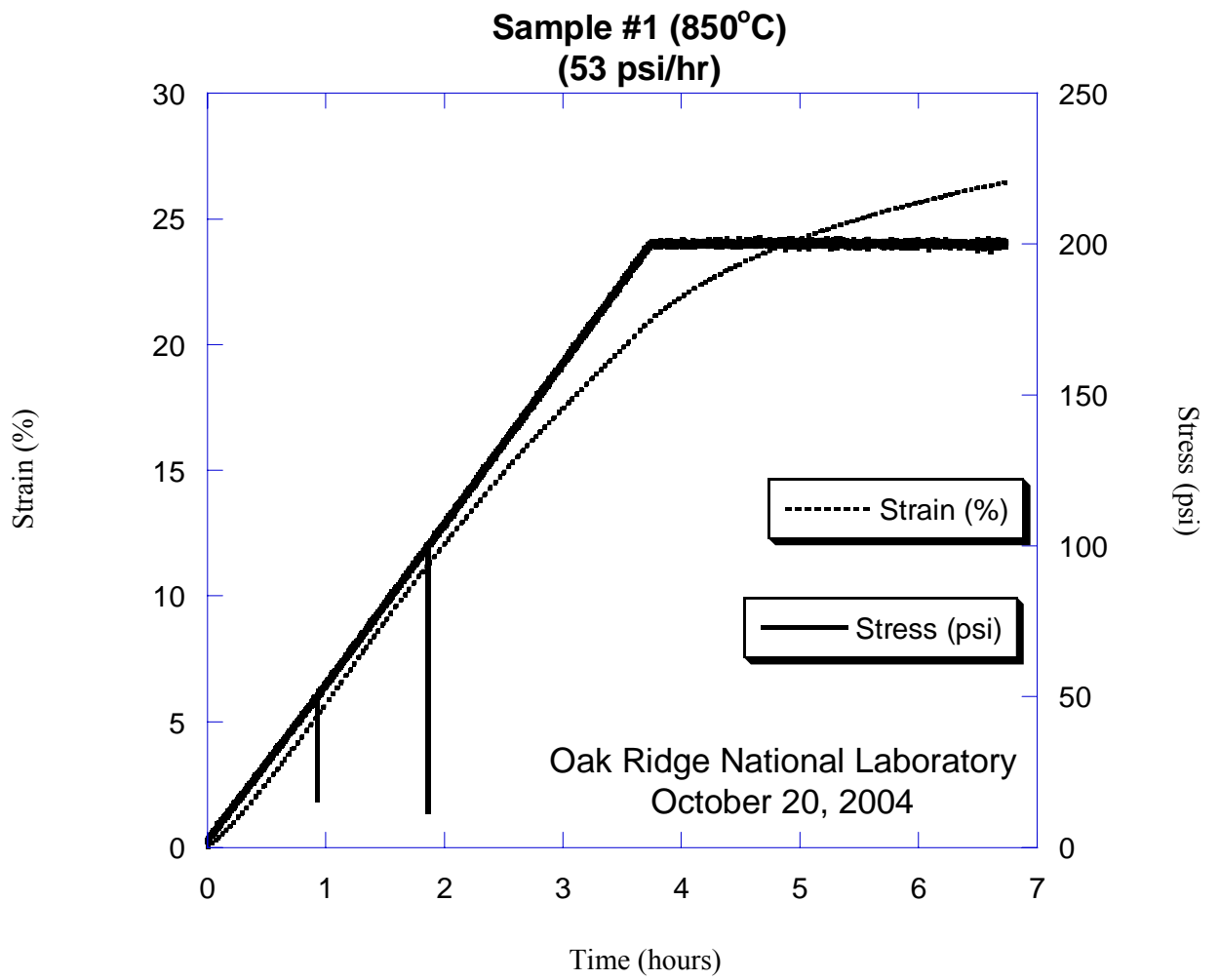

Figure 5. Results from Preliminary High Temperature Compression Testing



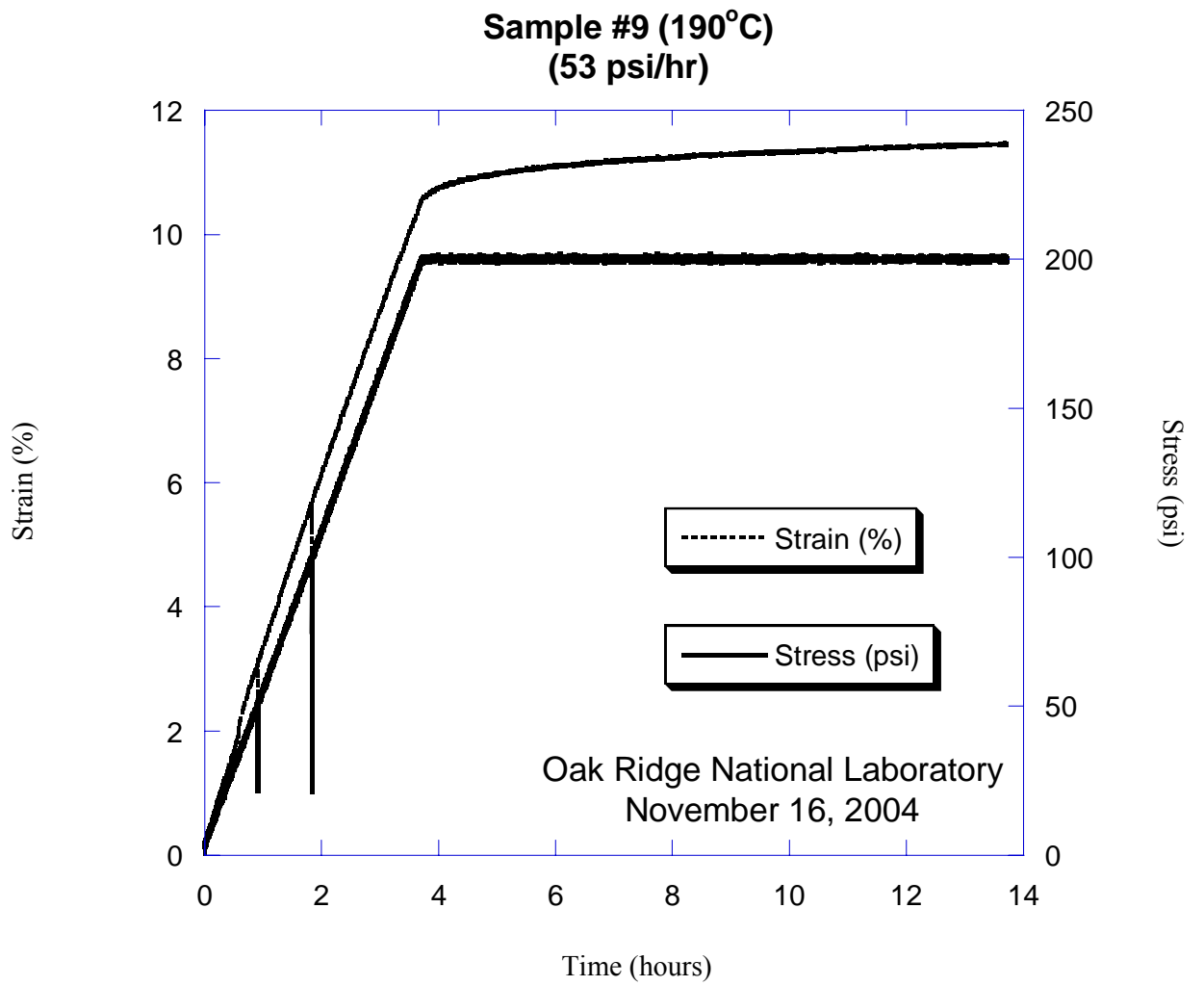

Figure 6. Typical Results from High Temperature Compression Testing

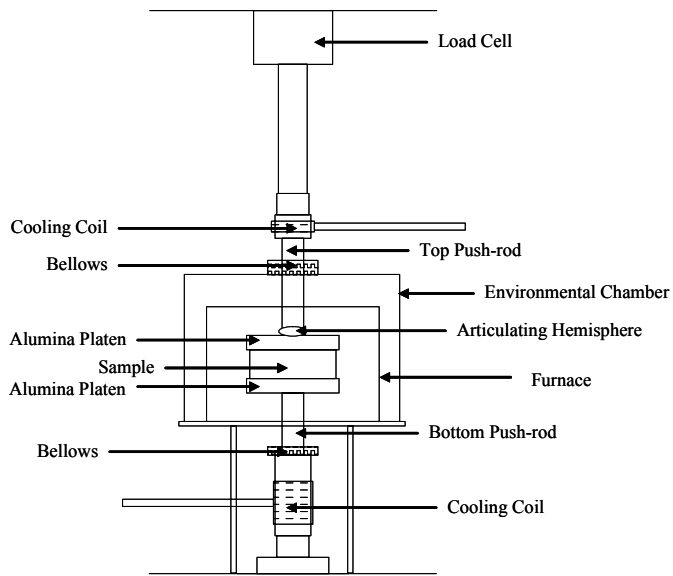
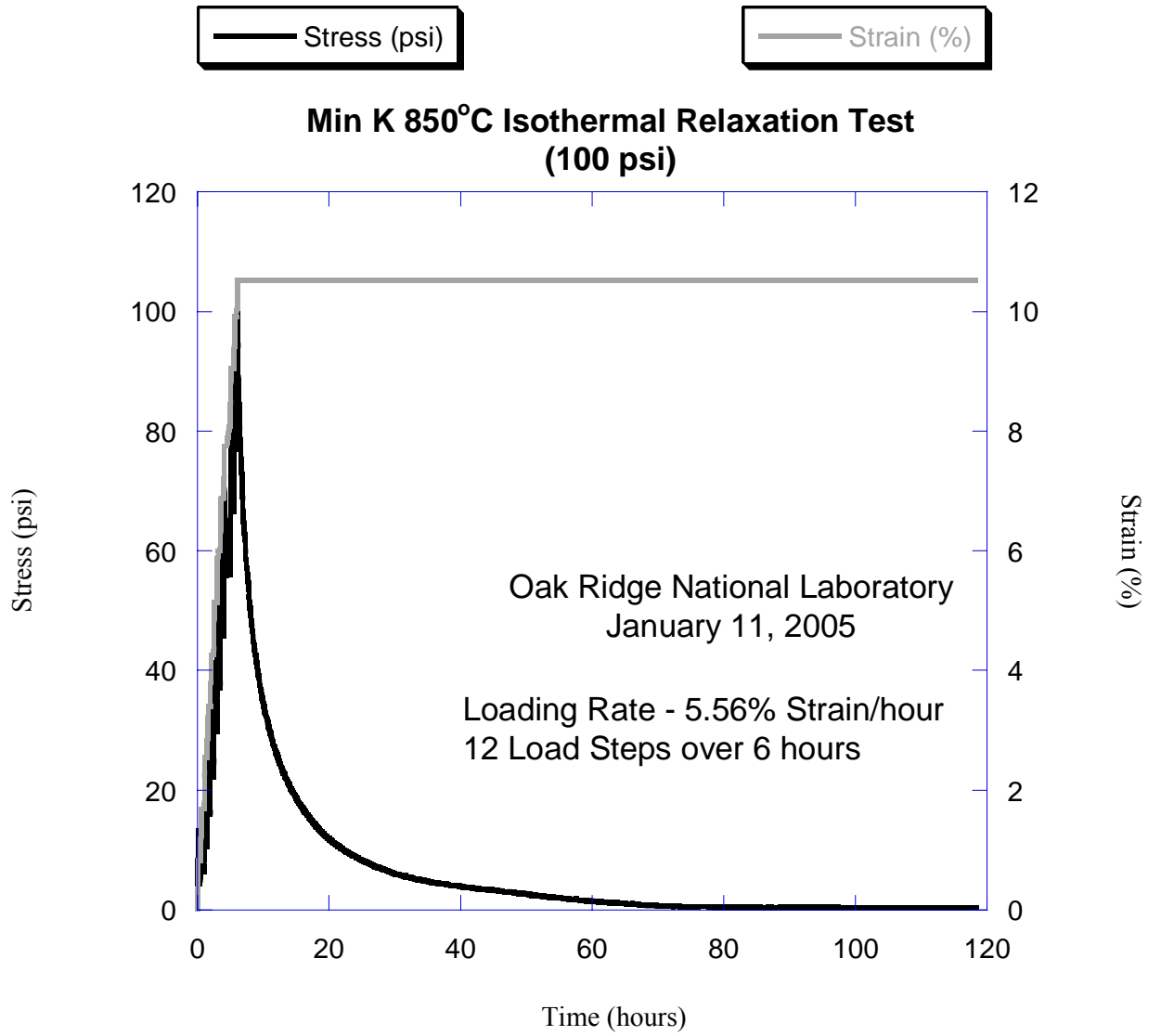

Figure 7. Isothermal Stress Relaxation Test Frame





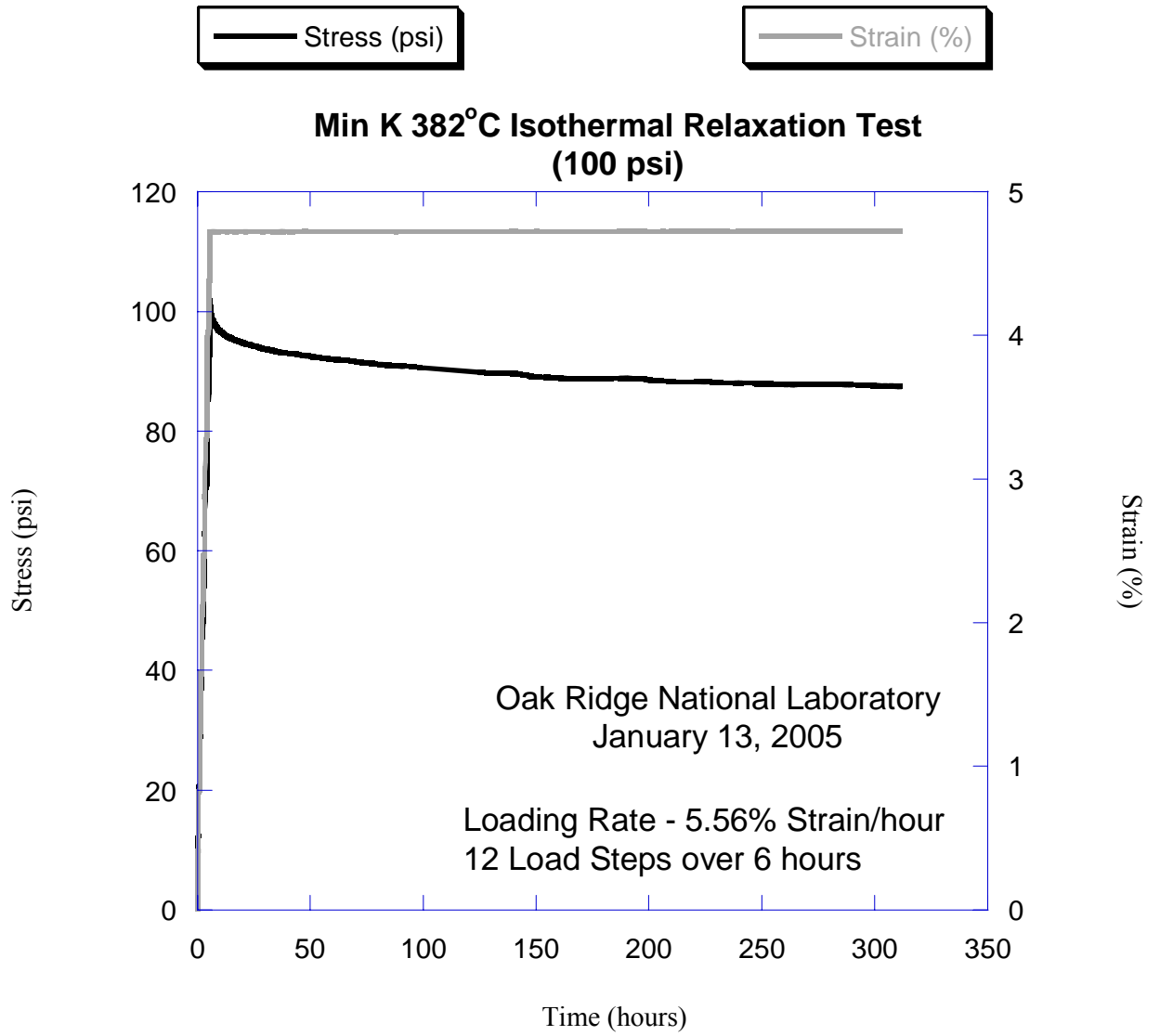

Figure 8. Typical Results from Isothermal Stress Relaxation Testing

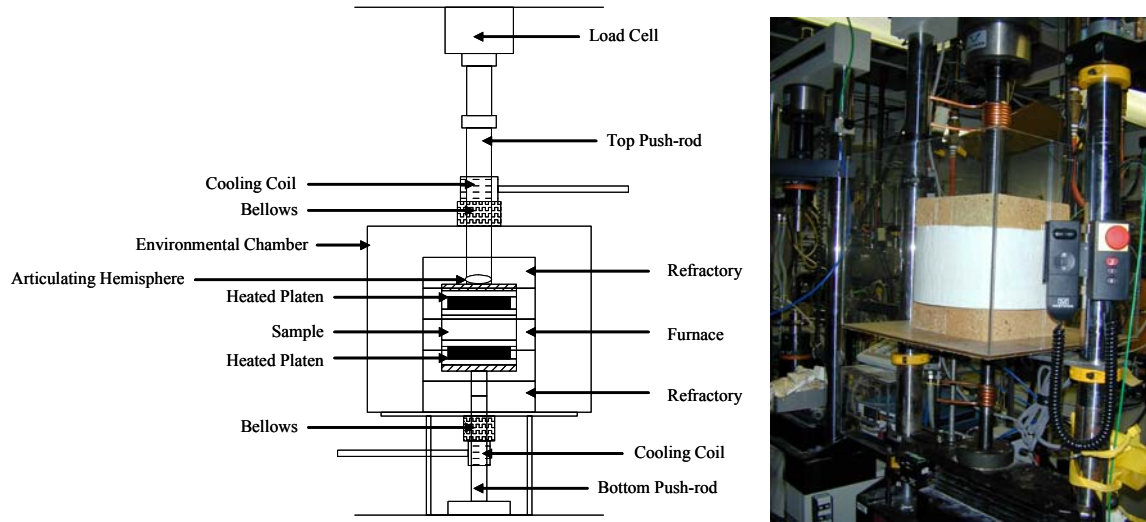

Figure 9. Gradient Stress Relaxation Test Frame



Figure 10. Installed Back-Up Power Supply System for Gradient Test Systems



Figure 11. Picture of Modified Gradient Stress Relaxation Test Frame

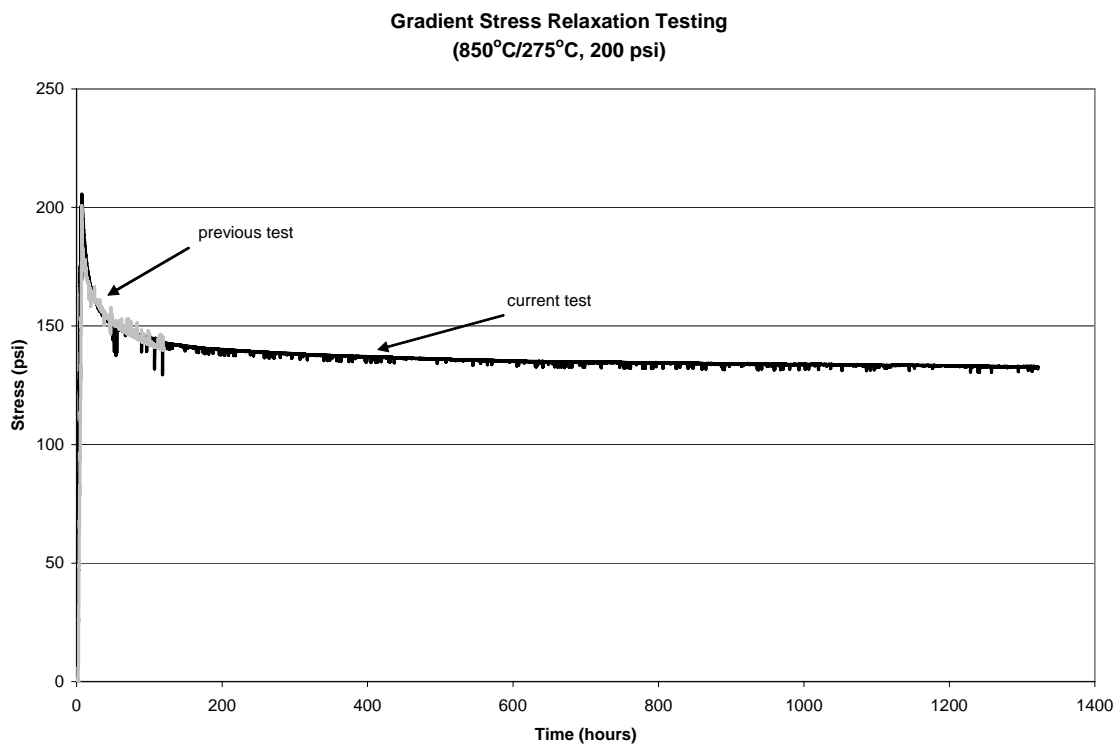

Figure 12. Typical Result from Initial Gradient Stress Relaxation Testing

**Gradient Test #9**  
**(700/100°C, 200 psi)**

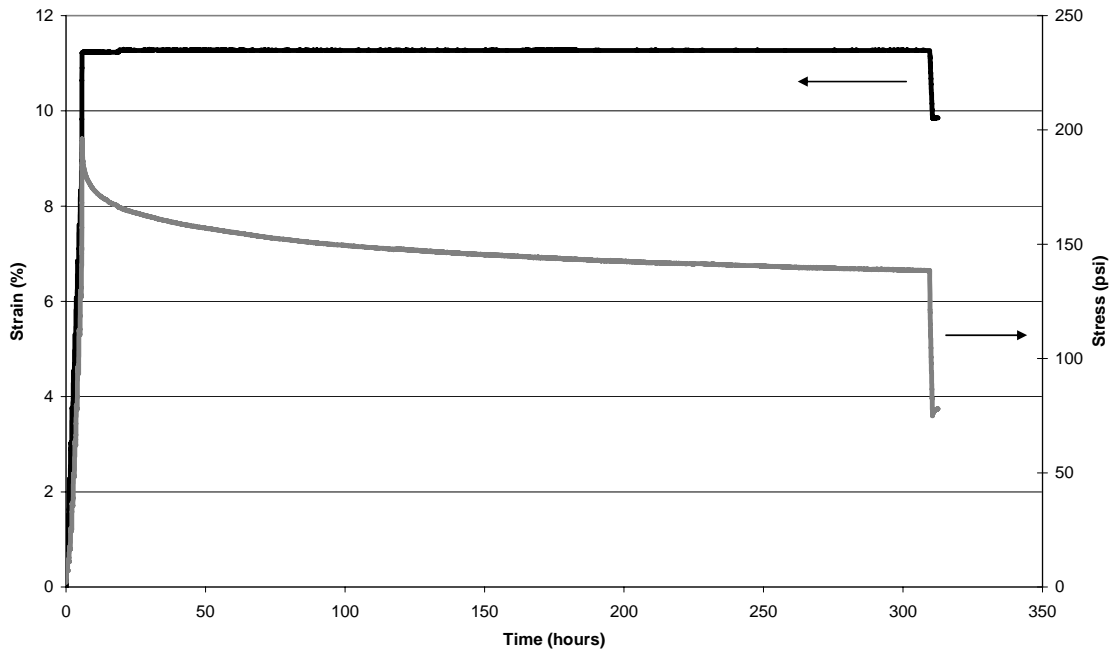

Figure 13. Results from Initial 700/100°C Gradient Stress Relaxation Test with Unloading Study at Conclusion of Test

**Gradient Test #8**  
**(800/190°C, 200 psi)**

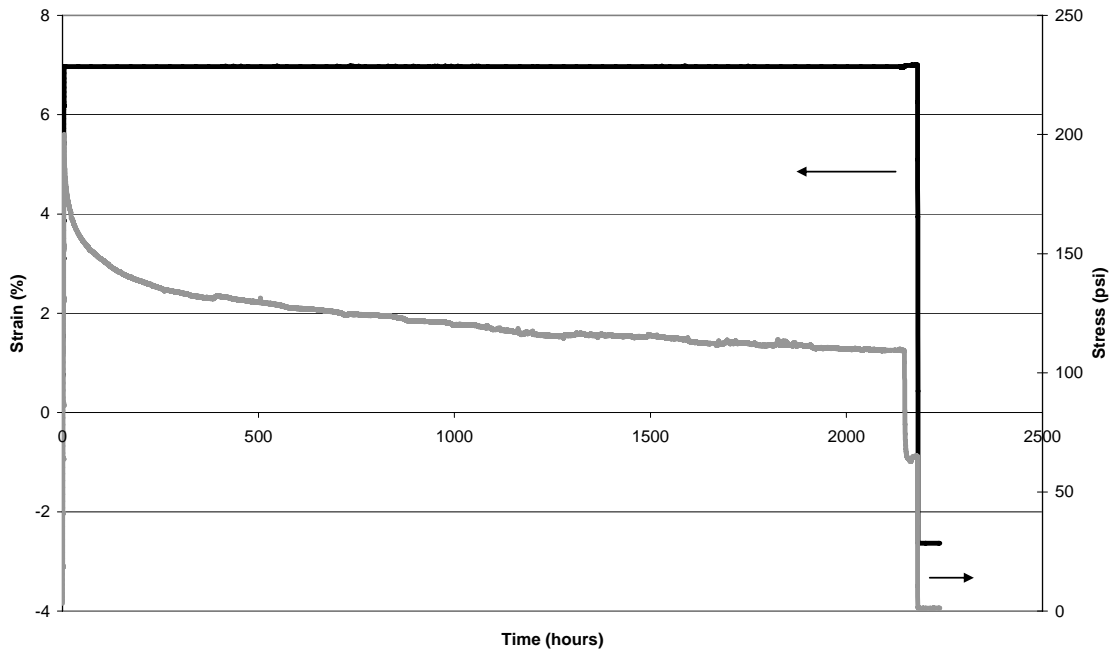
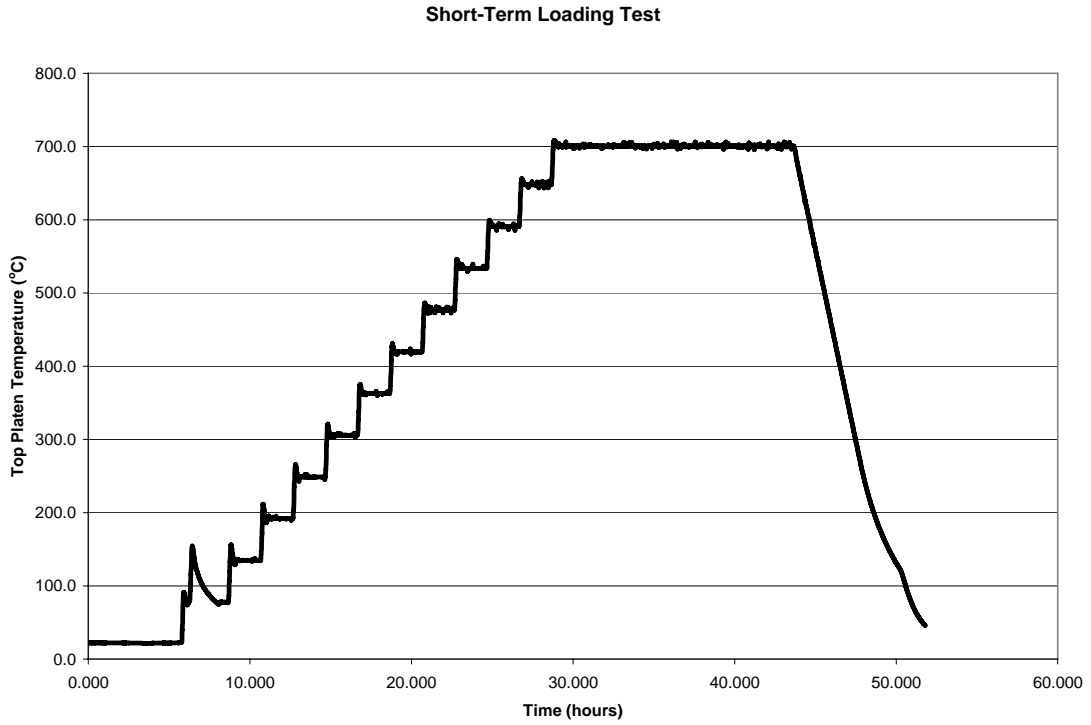
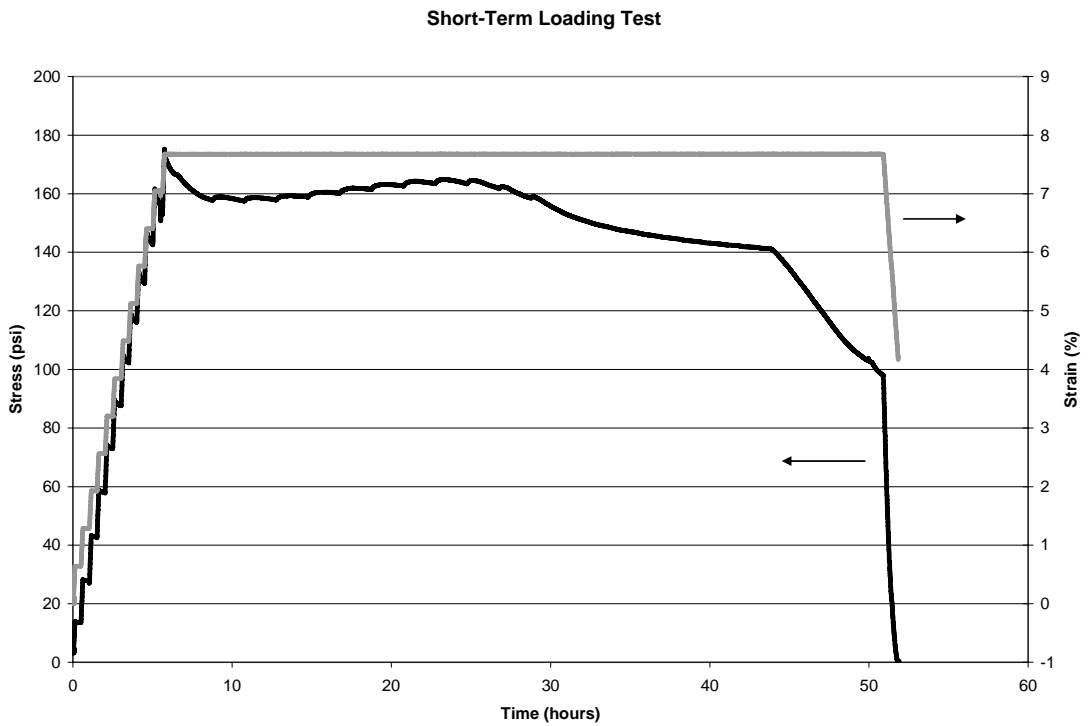

Figure 14. Results from 800/190°C Gradient Stress Relaxation Test Ended Due to Loss of Top Platen



a)



b)

Figure 15. Results from Short-Term Loading Test to Evaluate Min-K Performance Under Actual Expected Loading Conditions – (a) Temperature Cycle, (b) Stress and Strain Behavior

**Gradient Test #10**  
**(700/100°C, 200 psi)**

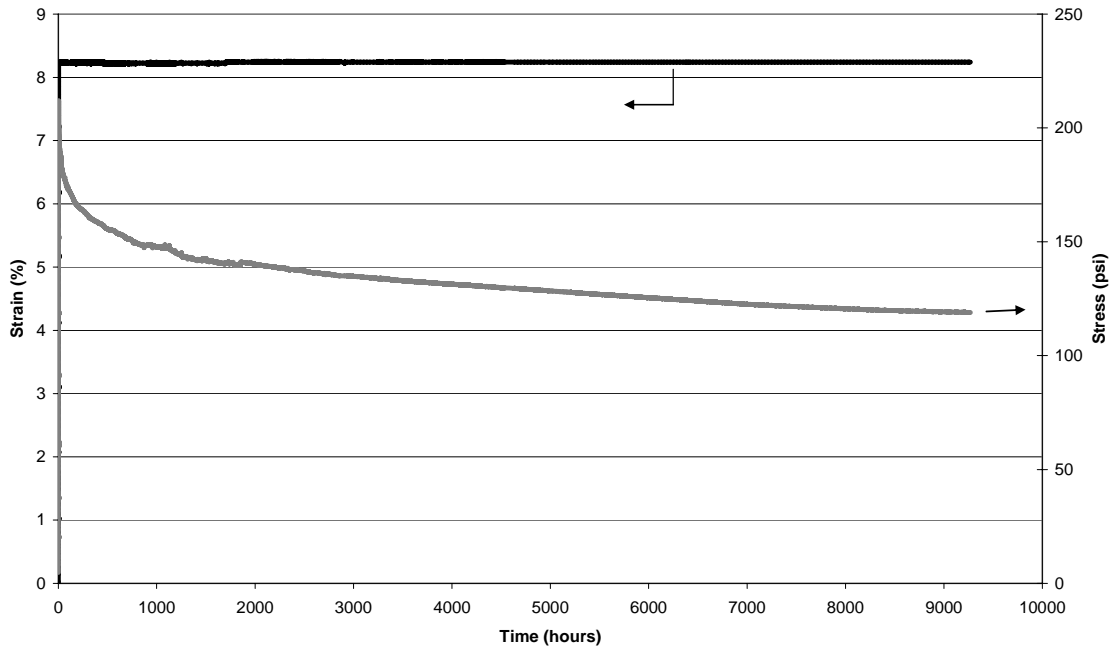

Figure 16. Results from 700/100°C Gradient Stress Relaxation Test (Test #10)

**Gradient Test #11**  
**(700/100°C, 200 psi)**

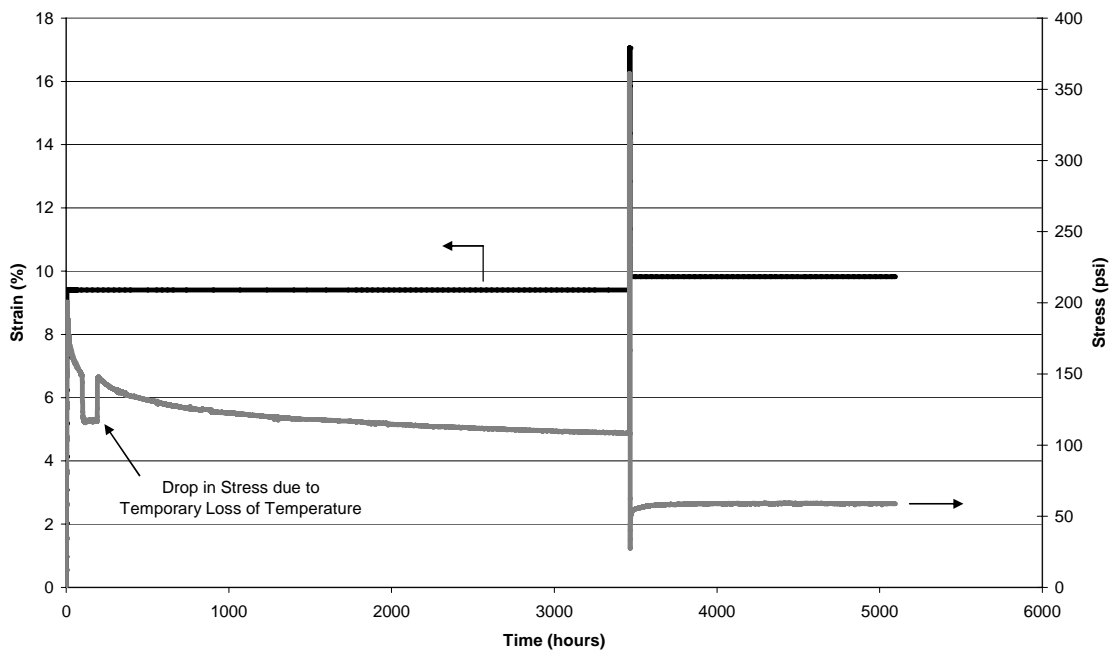

Figure 17. Results from 700/100°C Gradient Stress Relaxation Test (Test #11)

**Gradient Test #13**  
**(700/100°C, 200 psi)**

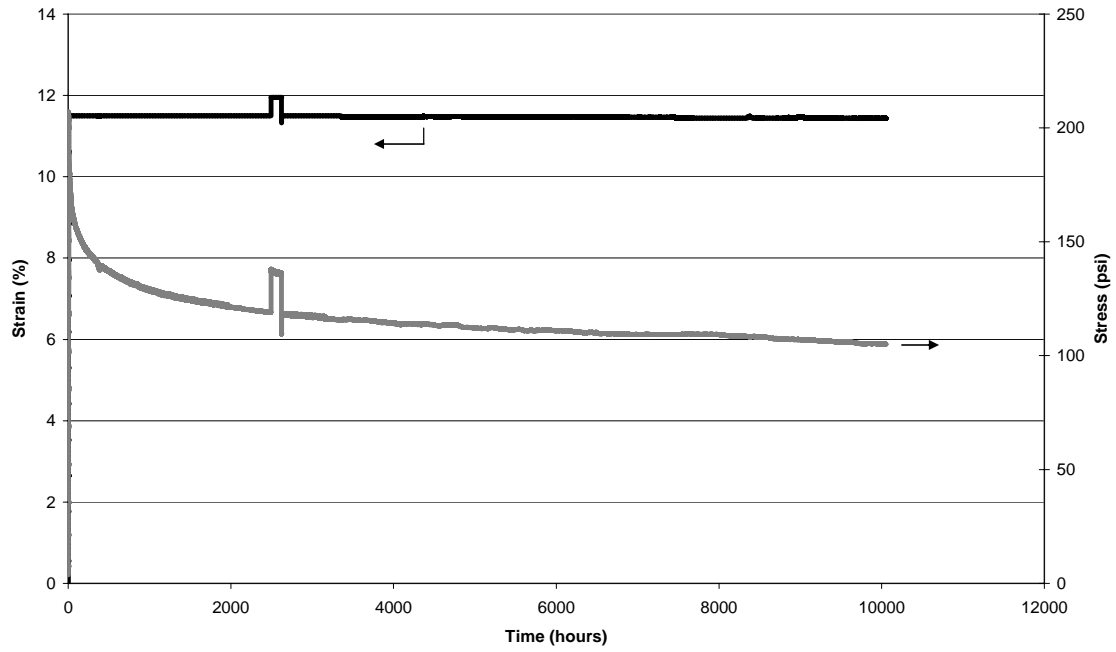

Figure 18. Results from 700/100°C Gradient Stress Relaxation Test (Test #13)

**Gradient Test #15**  
**(700/100°C, 200 psi)**

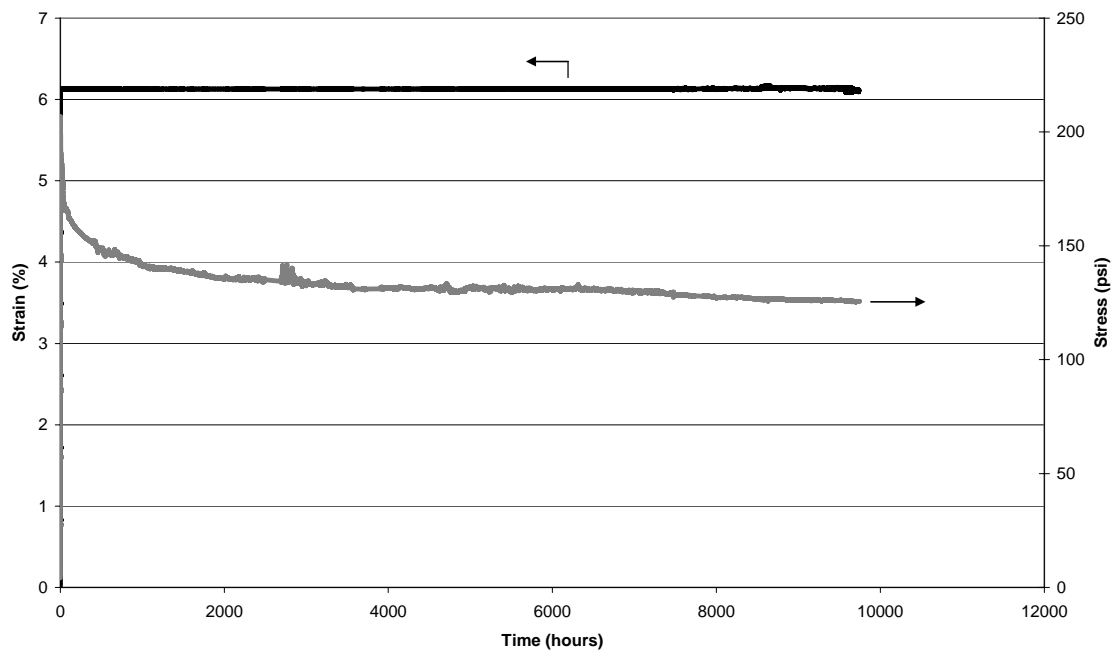

Figure 19. Results from 700/100°C Gradient Stress Relaxation Test (Test #15)

(1100-300°F, 7812 lbf.)

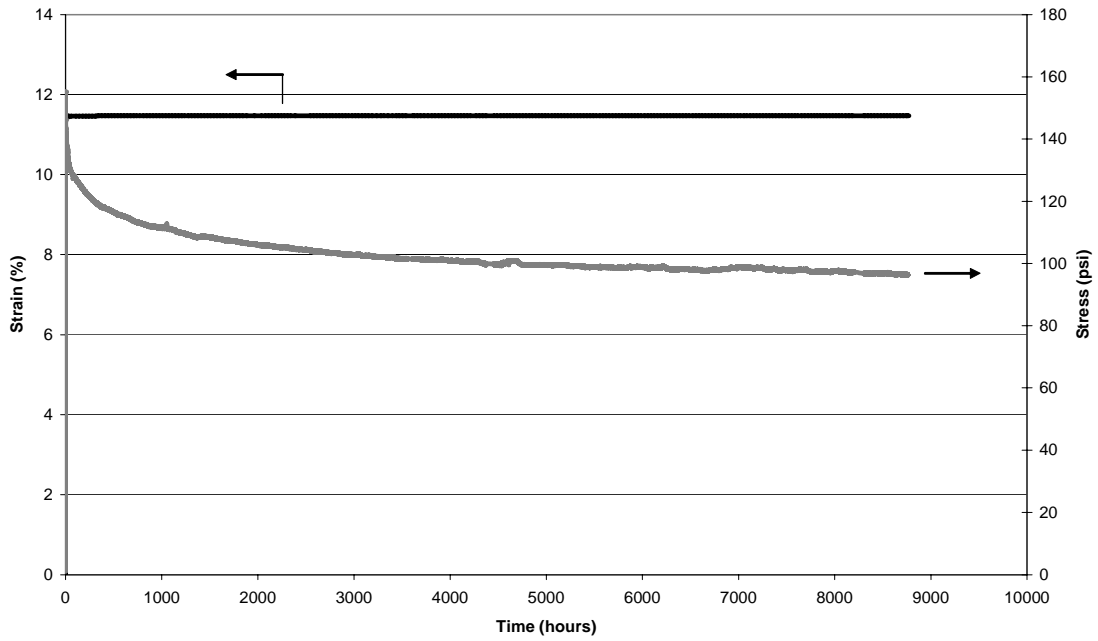

Figure 20. Results to date from 1,100/300°F Gradient Stress Relaxation Test

(1000-160°F, 7812 lbf.)

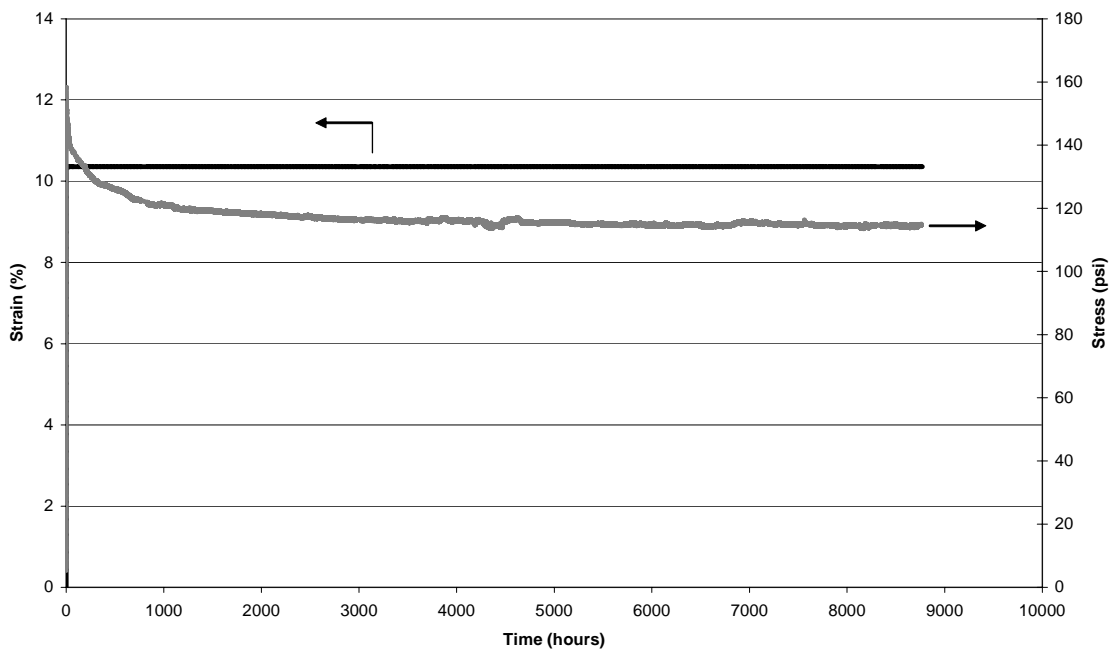

Figure 21. Results to date from 1,000/160°F Gradient Stress Relaxation Test



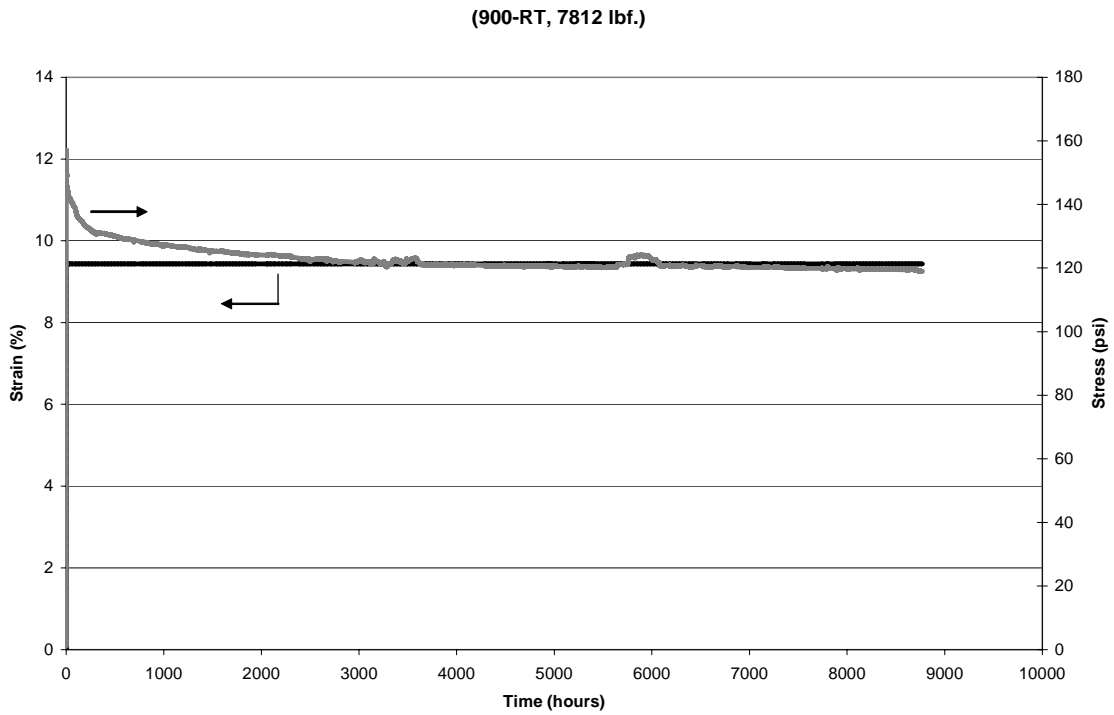

Figure 22. Results from to date from 900// $\approx$ 50°F Gradient Stress Relaxation Test

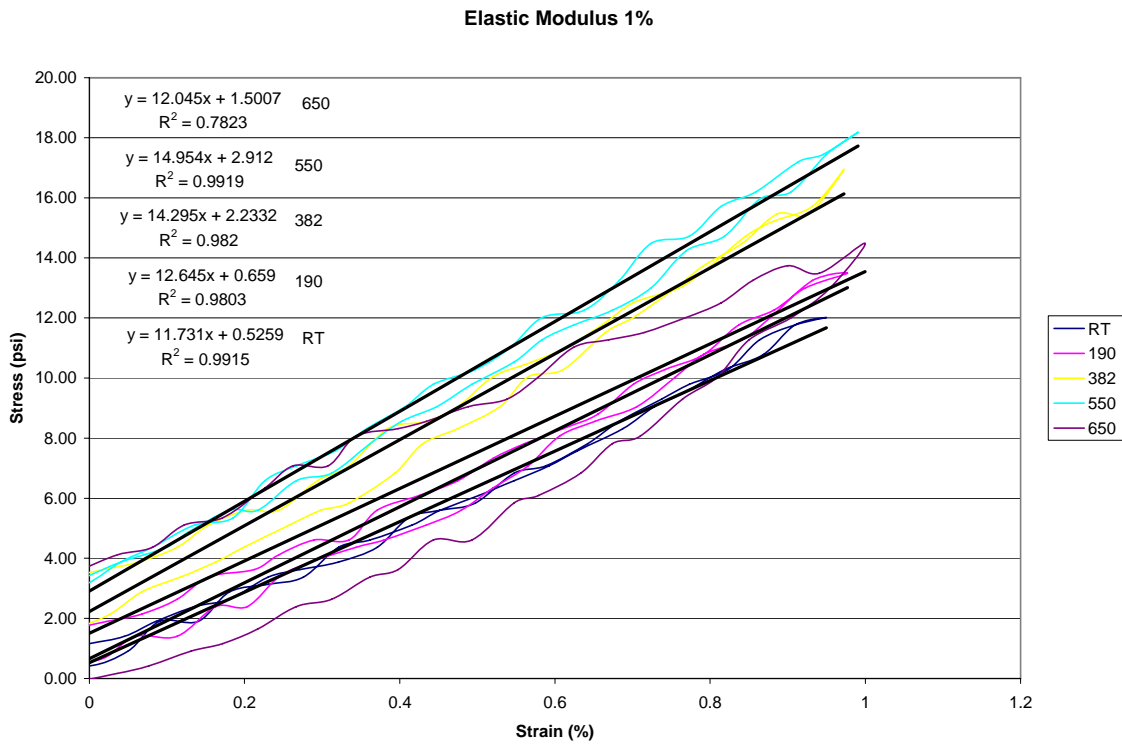

Figure 23. Results from Elastic Modulus Testing

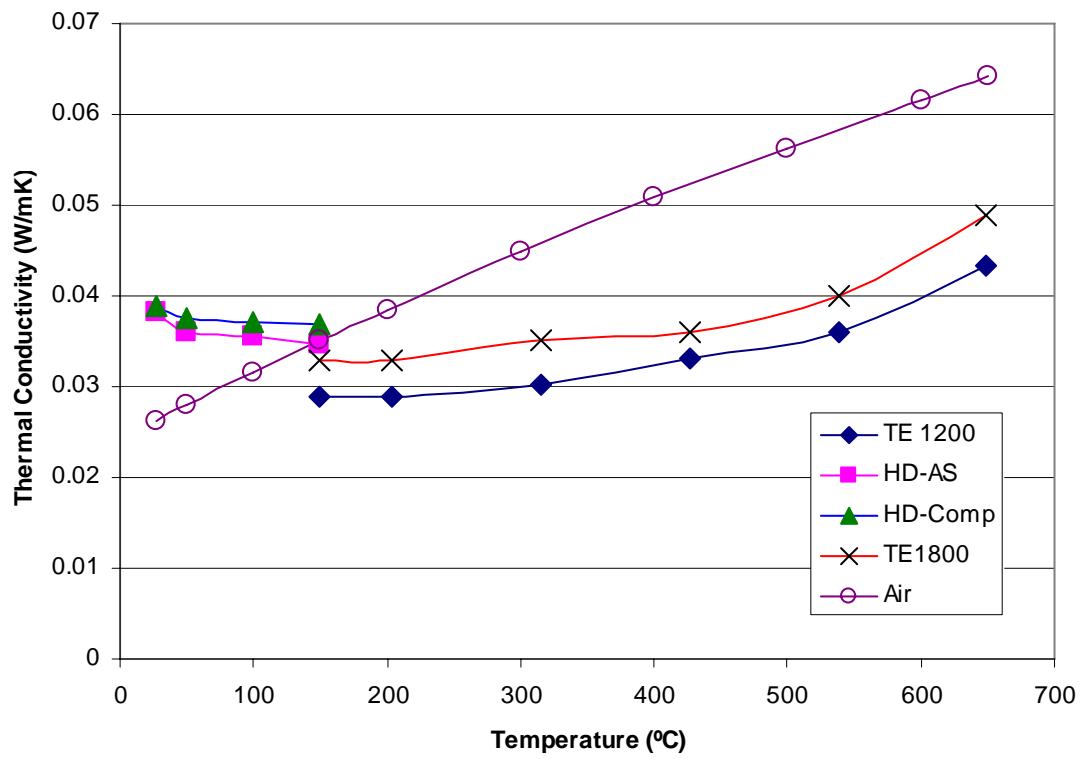
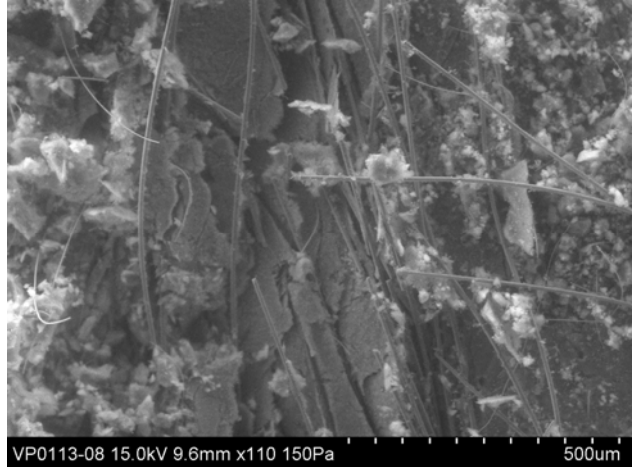
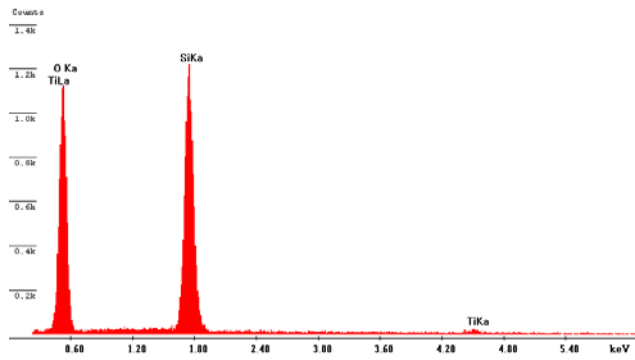

Figure 24. Results from Thermal Conductivity Testing



c:\edax32\genesis\genspc.spc

Label A: vp0120-01 large white particle encasing whisker in center



c:\edax32\genesis\genspc.spc

Label A: vp0120-05 small bright white particle on large white particle

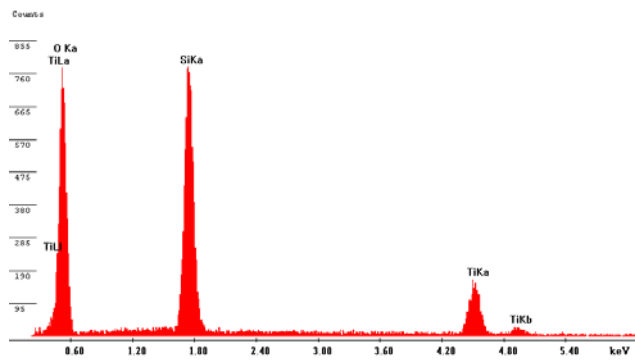

(fiber)

(matrix)

Figure 25. Typical Results from SEM/EDS Analysis

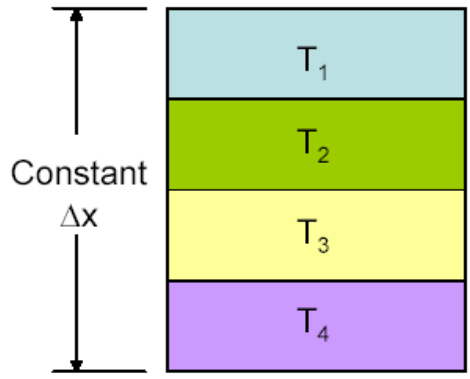

Figure 26. Discretized Gradient Model

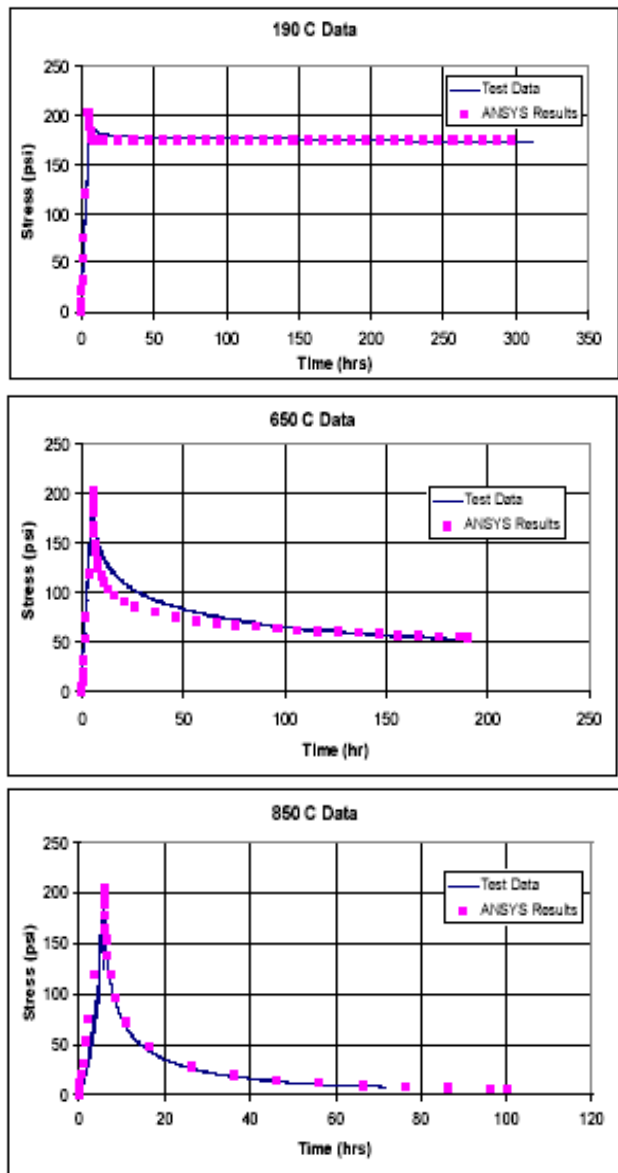

Figure 27. Comparison of Experimental Results to FEA Predictions

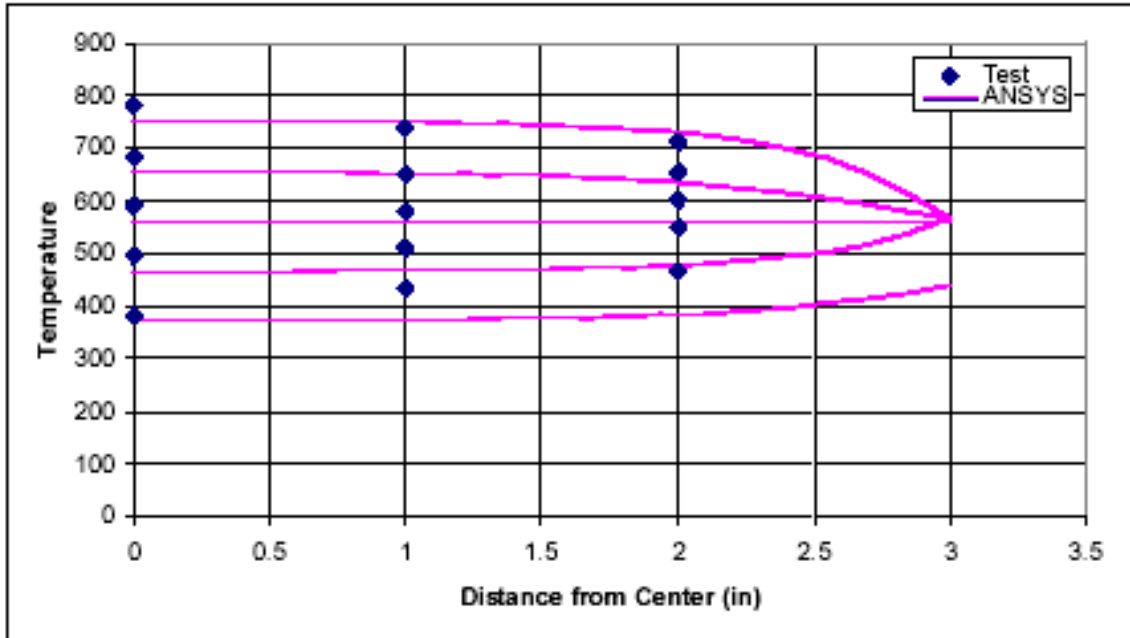

Figure 28. Comparison of Temperature Distributions Determined Experimentally and Extrapolated from FEA Model

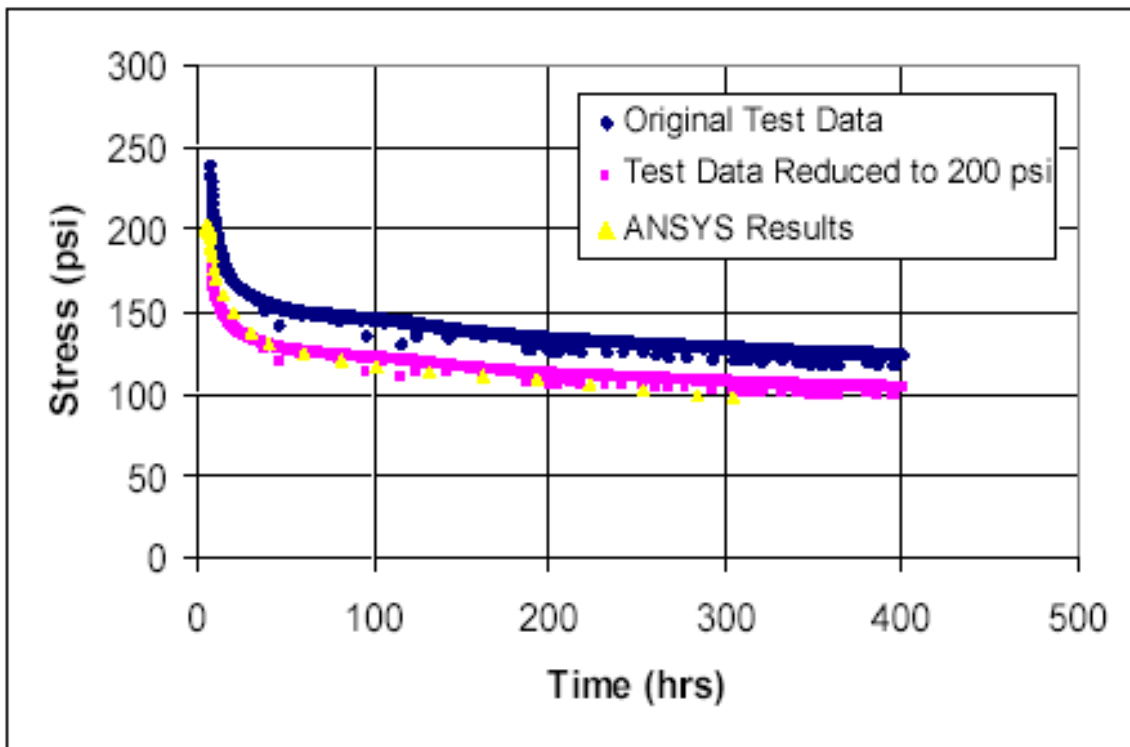

Figure 29. Comparison of Experimental Data and FEA Predictions

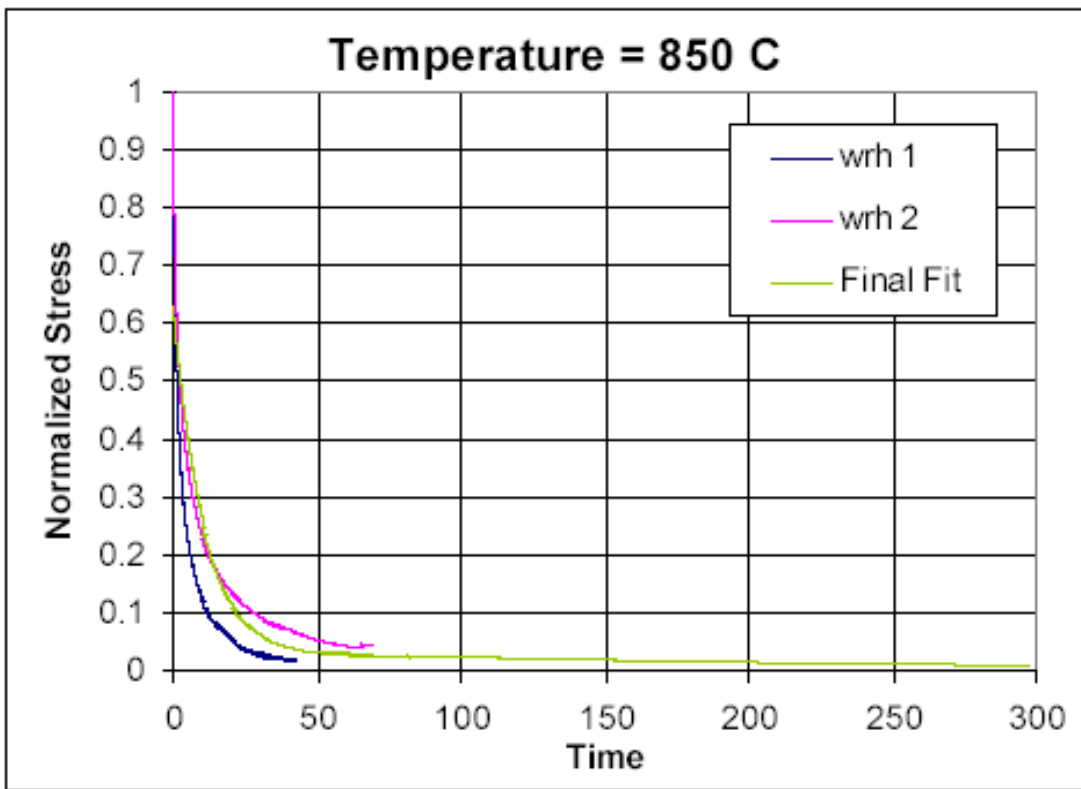
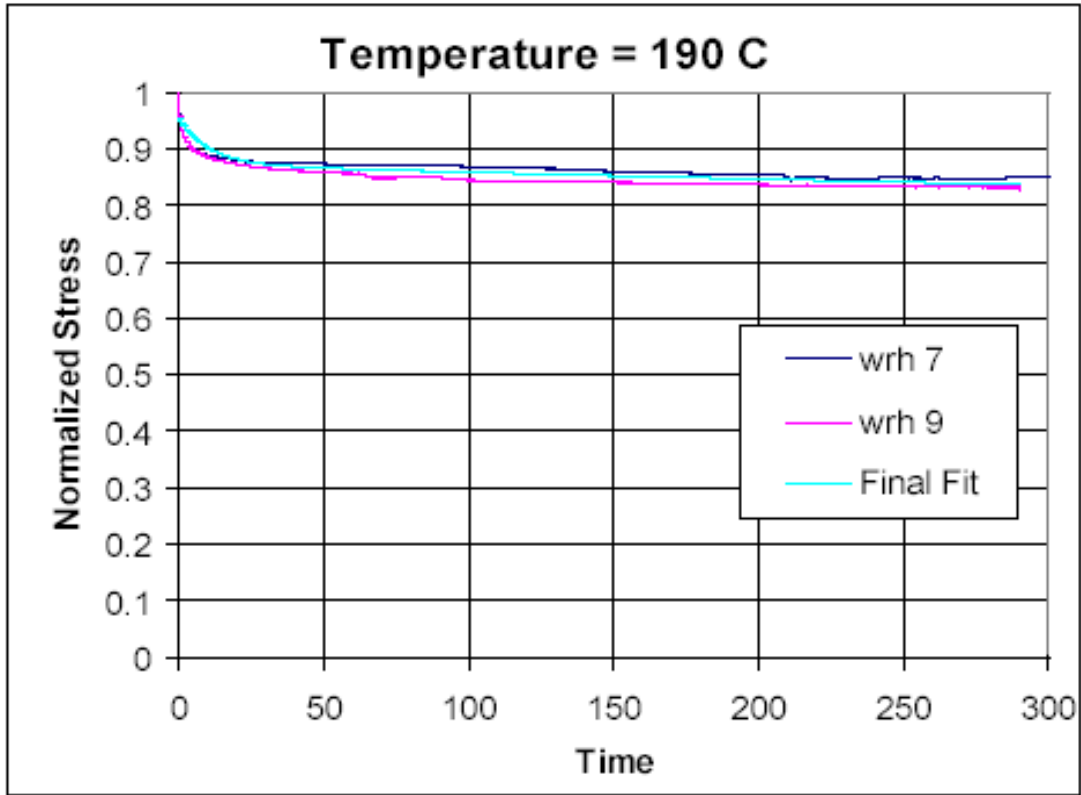
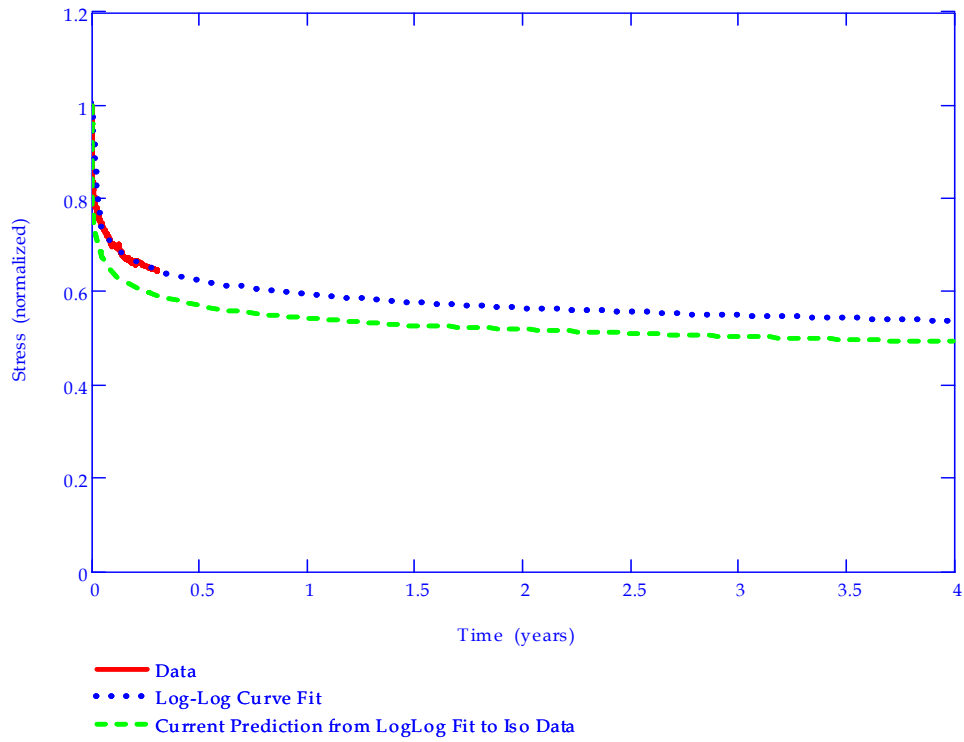
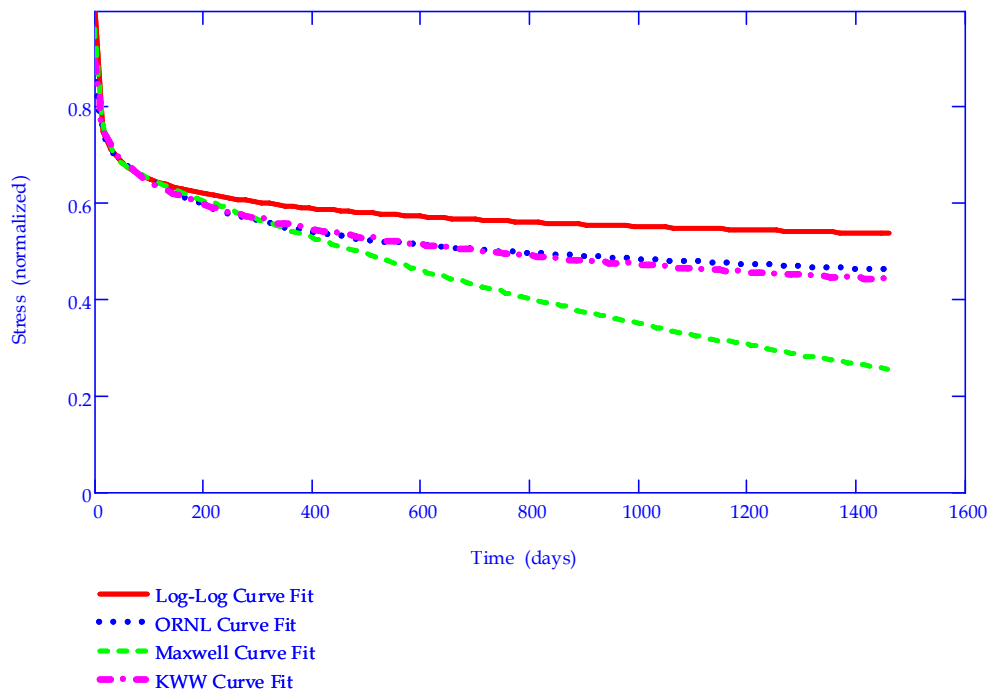

Figure 30. Typical Results from Fitting of Closed Form Model

### Gradient 10 Test Status (as of 6/2/2006)



### Gradient Test 10 Comparison of the Resulting Curve Fits (as of 6/2/06)



### Gradient 11 Test Status (as of 6/2/2006)

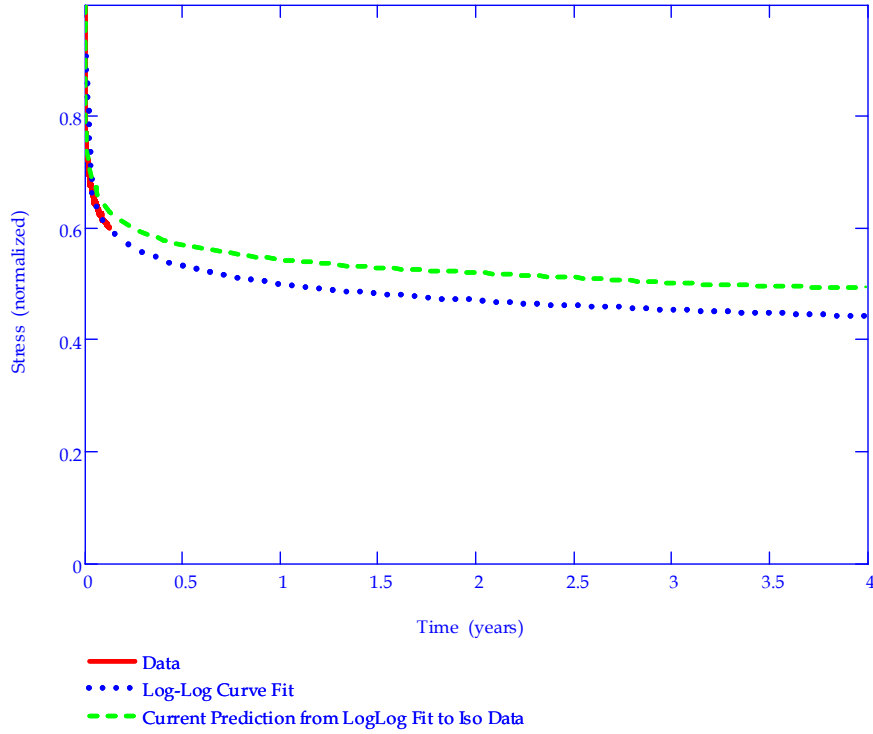

### Gradient Test 11 Comparison of the Resulting Curve Fits (as of 6/22/06)

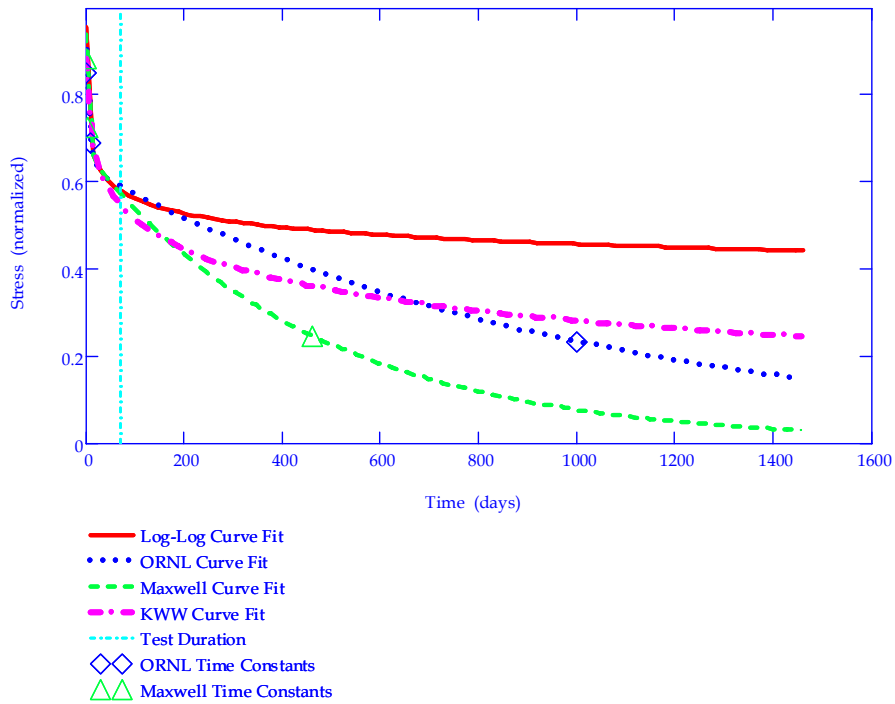
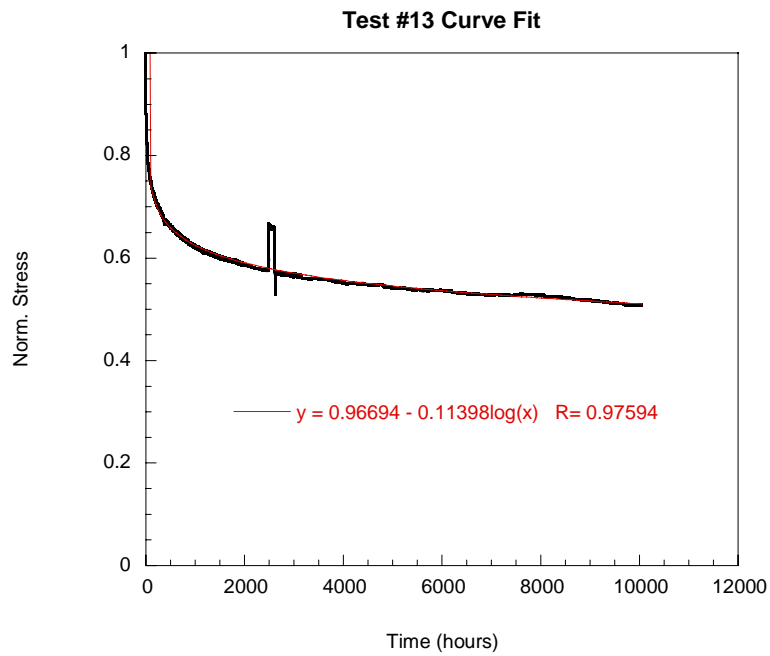
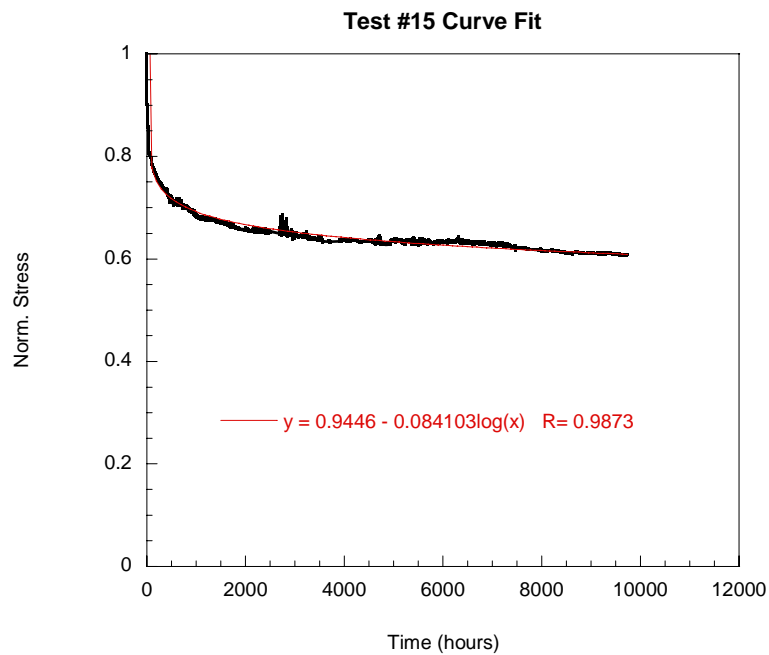

Figure 31. Examples of Curve Fit Convergence for Gradient Stress Relaxation Tests #10 and #11





a)



b)

Figure 32. Log Function Curve Fits of Long-Term Gradient Stress Relaxation Data  
(a – Test #13, b – Test #15)

Test #13 Curve Fits

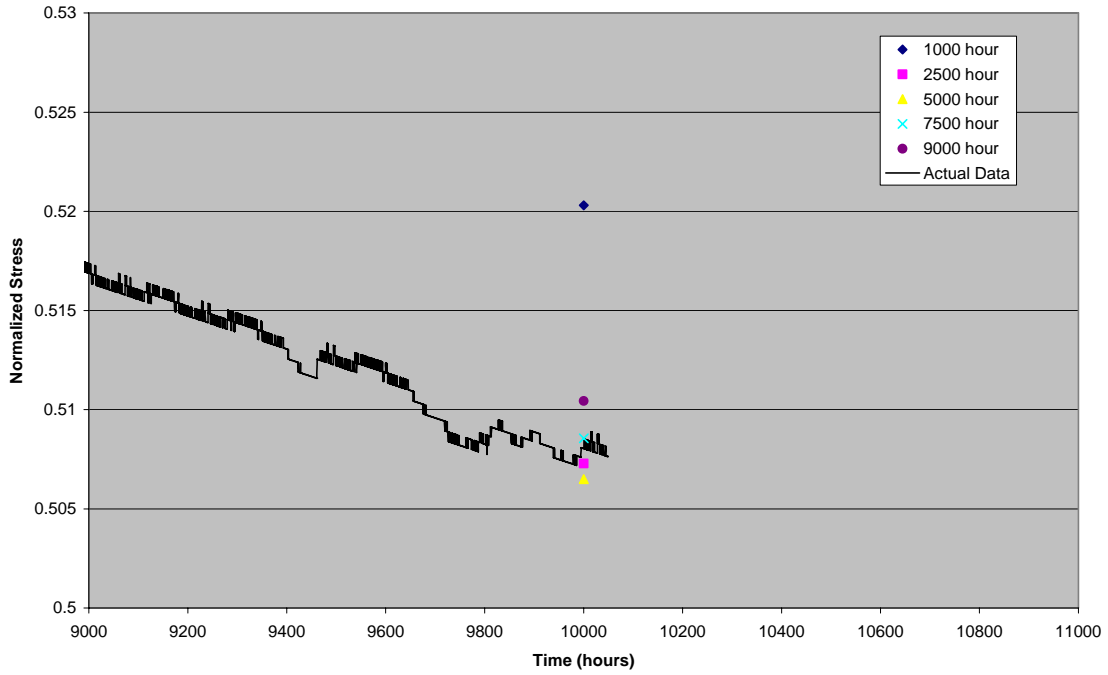

Test #13 Curve Fits

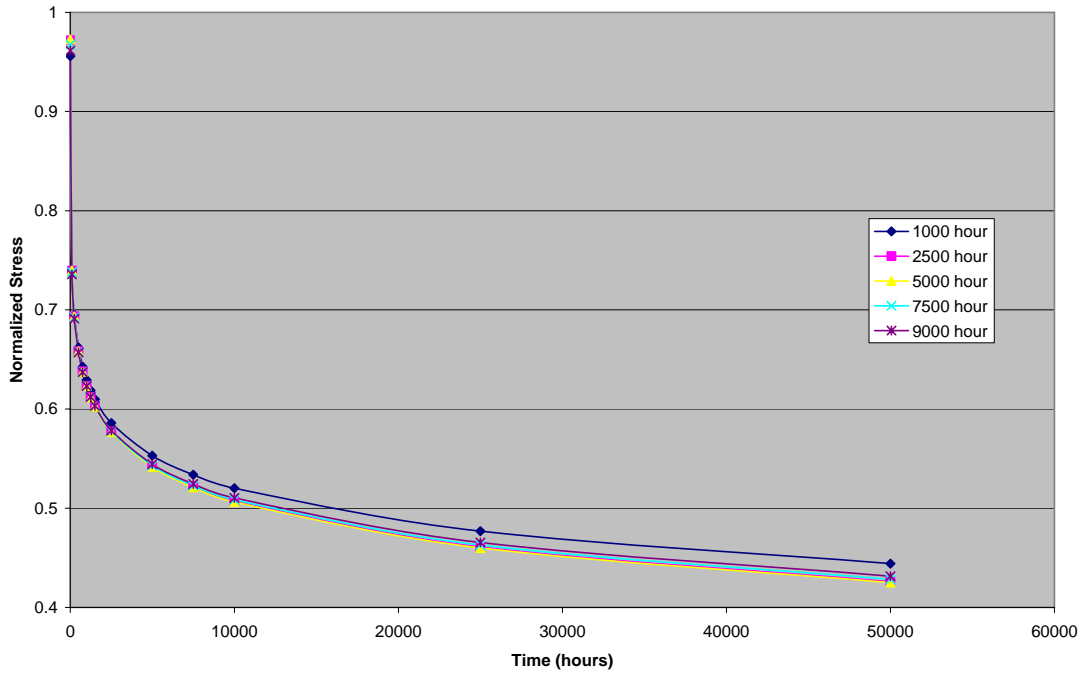
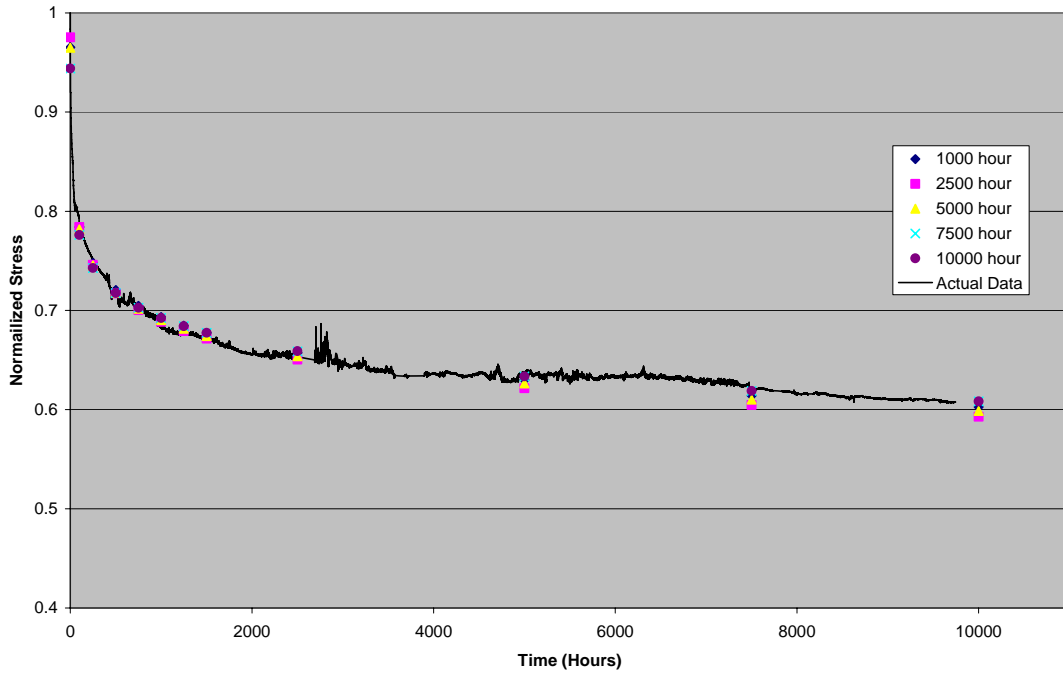

Figure 33. Gradient Test #13 Log Fit Predictions

Test #15 Curve Fits



Test #15 Curve Fits

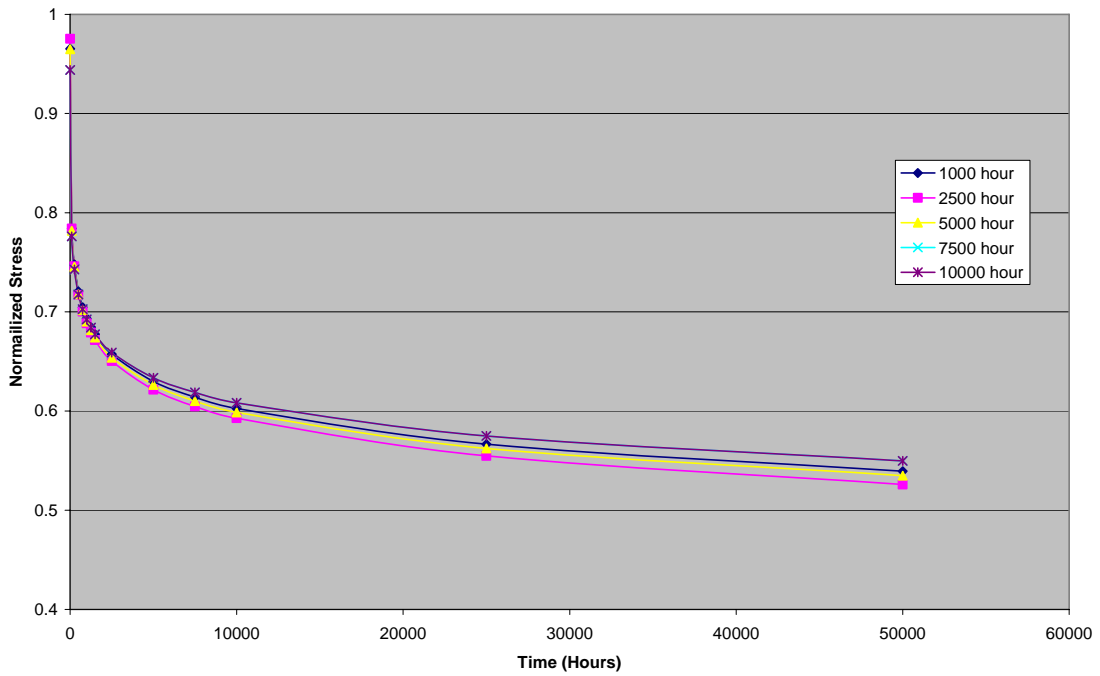
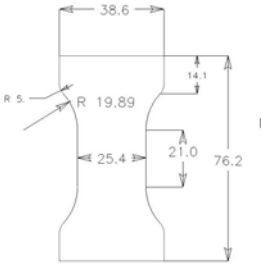
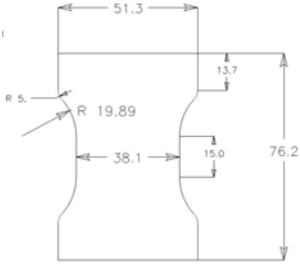

Figure 34. Gradient Test #15 Log Fit Predictions



Appendix 1

Min-K Testing and Characterization  
 Test Matrix: Preliminary Compression Tests  
 (Hour-Glass Specimen Geometries)

Specimen Geometry (Dimensions in mm)	Specimen ID	Density (lbs./in <sup>3</sup> )	$\sigma_y$ (psi)	E (x 10 <sup>4</sup> psi)	$\epsilon_{perm.}$ (%)
 <p>(1'')</p>	2	0.0124	109	24.16 24.99 22.33	2.05
	12*	0.0125	92	24.24 24.82 21.23	---
 <p>(1.5'')</p>	4**	0.0135	92	24.97 22.56	0.38
	7	0.0134	103	24.48 22.81 22.75	1.21

\* run to very high loads (and failure) when wrong test program was used

\*\* only run to 150 psi (2 loading cycles) before test was prematurely ended

Min-K Testing and Characterization  
 Test Matrix: Preliminary Compression Tests  
 (Hour-Glass Specimen Geometries)

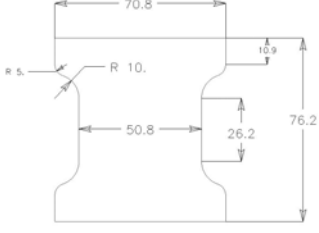
Specimen Geometry (Dimensions in mm)	Specimen ID	Density (lbs./in <sup>3</sup> )	$\sigma_y$ (psi)	E (x 10 <sup>4</sup> psi)	$\epsilon_{perm.}$ (%)
 <p style="text-align: center;">(2" Configuration a)</p>	1	0.0121	96	22.19 21.31 19.84	1.93
	3	0.0123	96	18.80 18.57 18.53	1.41
	5	0.0123	118	22.59 23.48 20.13	1.46
	10	0.0130	91	35.27 33.70 33.42	0.82
	13	0.0126	105	22.53 21.91 18.85	0.77

**Min-K Testing and Characterization**  
**Test Matrix: Preliminary Compression Tests**  
**(Hour-Glass Specimen Geometries)**

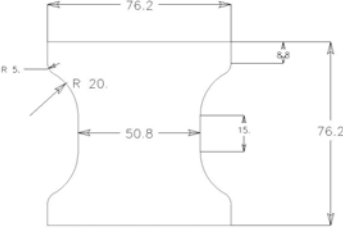
Specimen Geometry (Dimensions in mm)	Specimen ID	Density (lbs./in <sup>3</sup> )	$\sigma_y$ (psi)	E (x 10 <sup>4</sup> psi)	$\epsilon_{perm.}$ (%)
 <p style="text-align: center;">(2" Configuration b)</p>	6	0.0123	89	24.62 25.59 21.80	1.52
	8	0.0124	95	23.45 22.29 22.23	1.20
	9	0.0124	97	31.68 29.75 28.40	1.24
	11	0.0122	99	23.68 21.96 20.86	1.05
	14	0.0120	81	21.76 20.33 19.33	1.47

Min-K Testing and Characterization  
 Test Matrix: Preliminary Compression Tests  
 (Cylindrical Specimen Geometries)

Specimen Geometry (Dimensions in mm)	Specimen ID	Density (lbs./in <sup>3</sup> )	$\sigma_y$ (psi)	E (x 10 <sup>4</sup> psi)	$\epsilon_{perm.}$ (%)
<p style="text-align: center;">(2")</p>	15	0.0132	99	24.54 21.49 23.11	1.69
	16	0.0125	65	24.01 22.32 21.73	2.05
	17	0.0131	73	25.00 23.58 24.27	1.11
	18	0.0126	87	25.79 25.55 20.04	2.07
	19	0.0132	76	22.49 20.56 22.56	2.54



Appendix 2  
Isothermal Stress Relaxation Plots

850°C, 200 psi

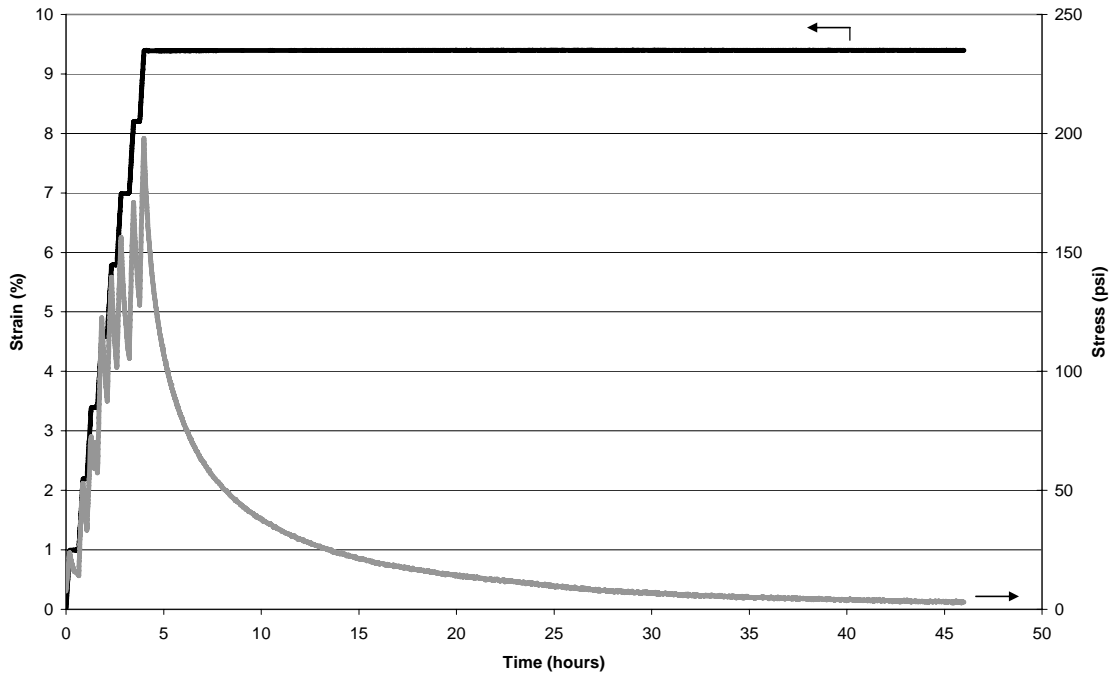

850°C, 200 psi

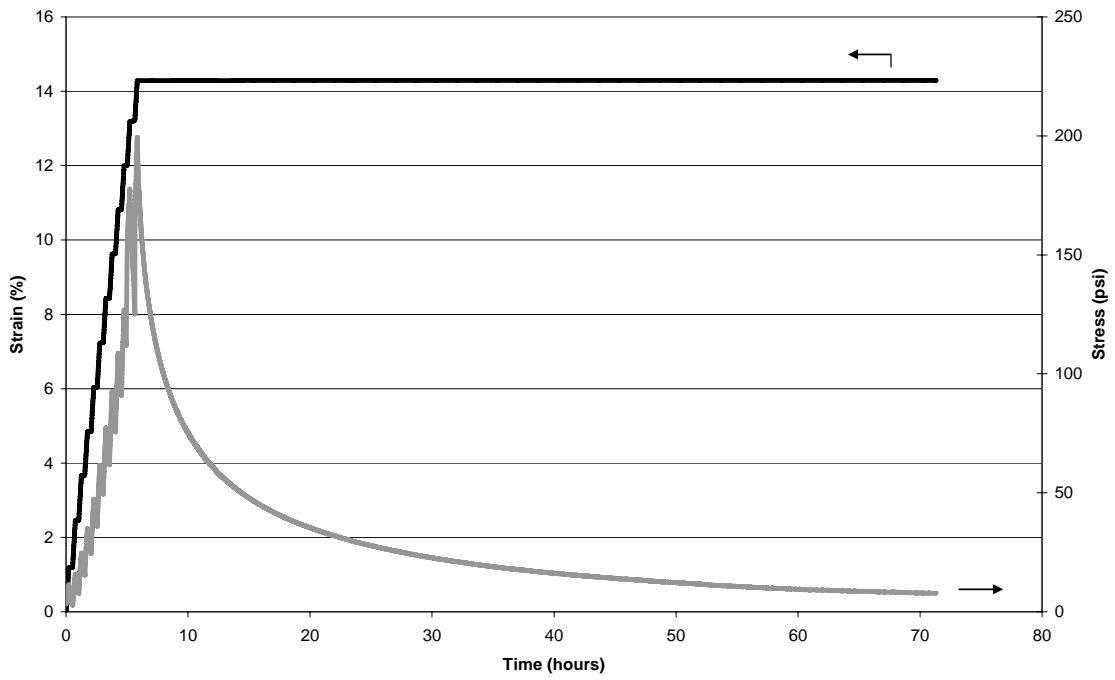

813°C, 200 psi

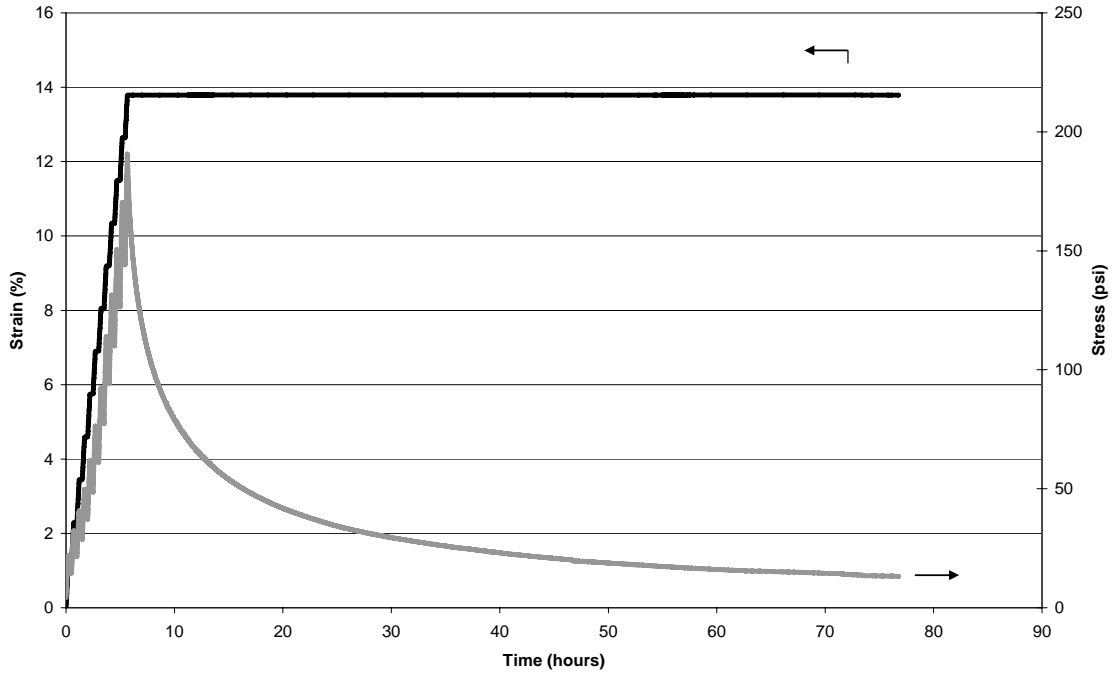

813°C, 200 psi

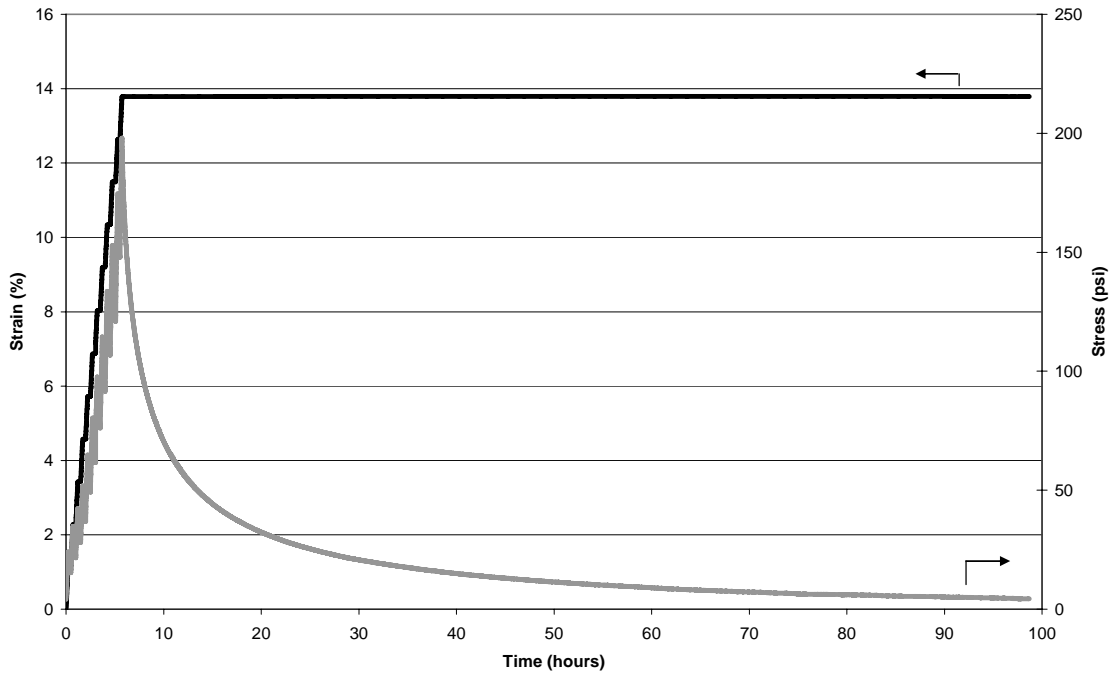

650°C, 200 psi

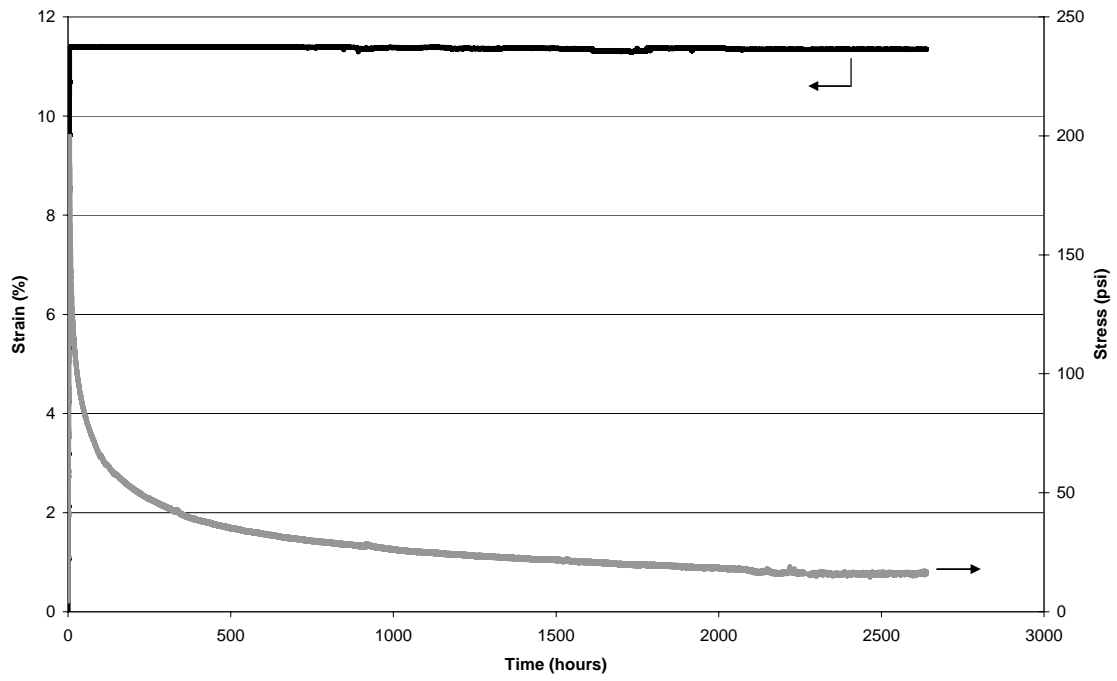

550°C, 200 psi

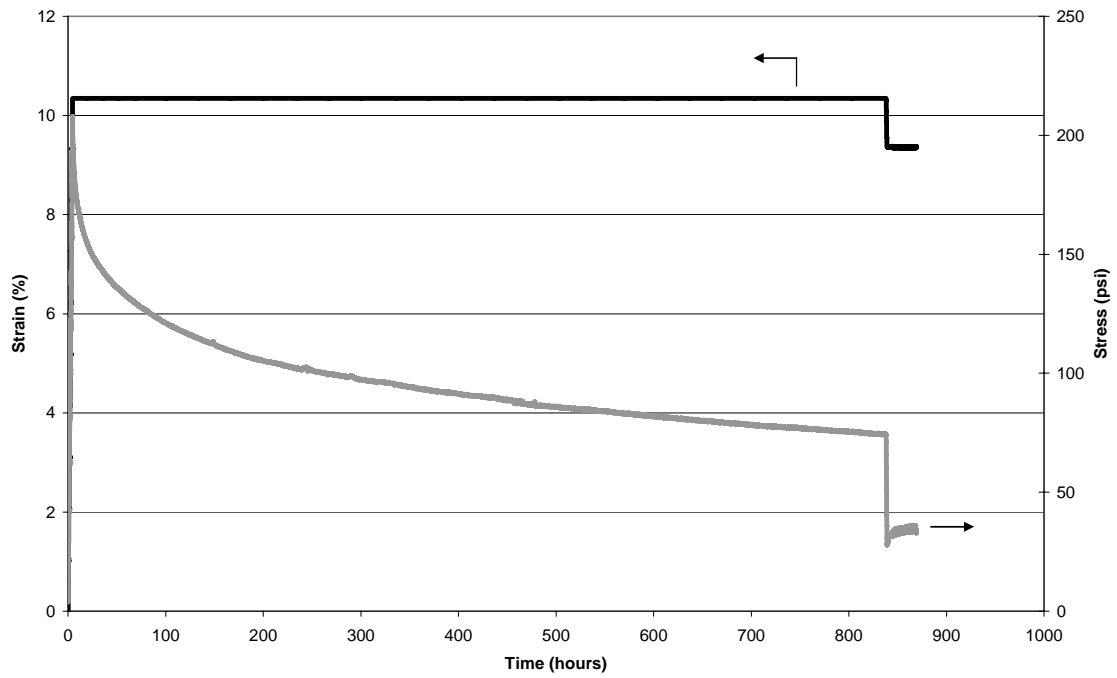

382°C, 200 psi

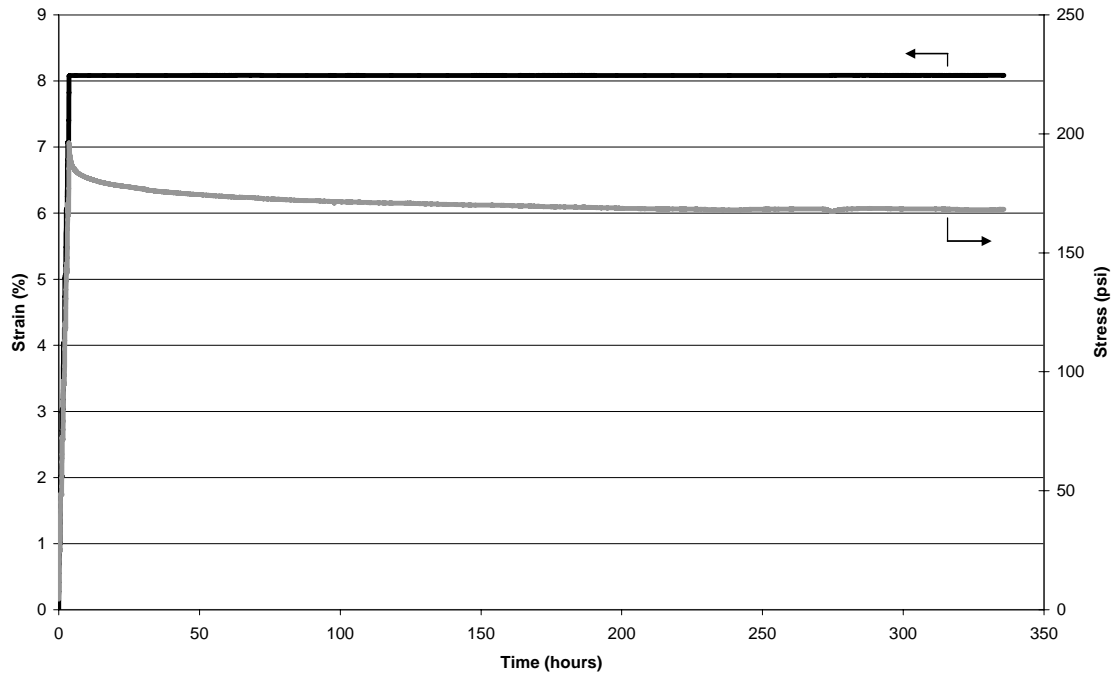

382°C, 200 psi

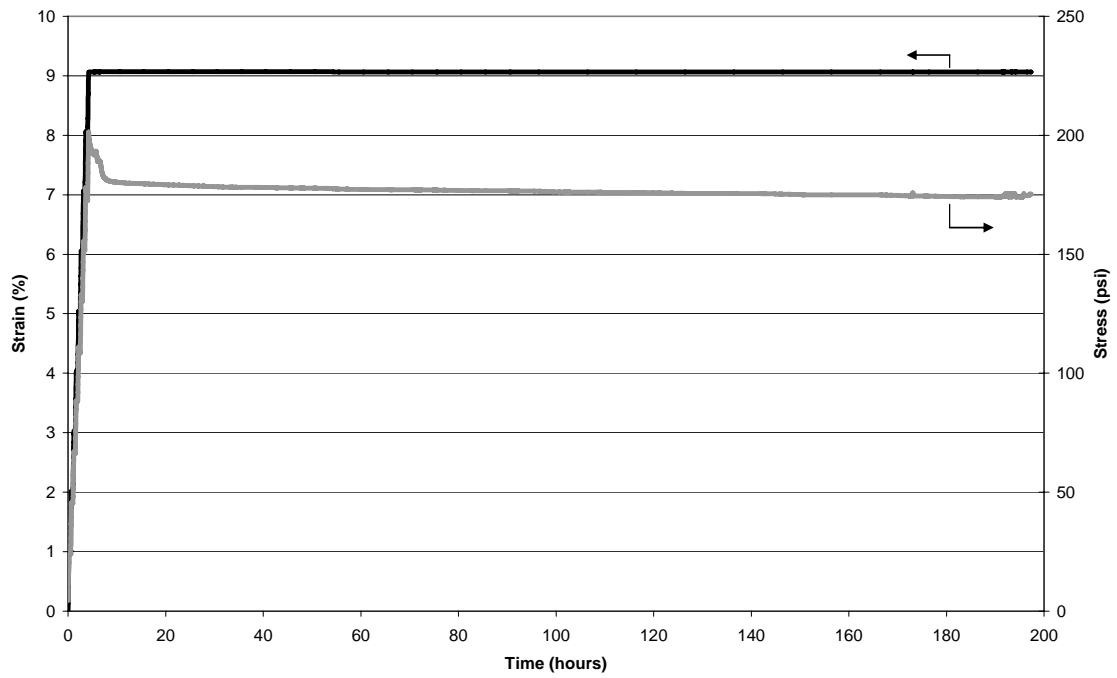

190°C, 200 psi

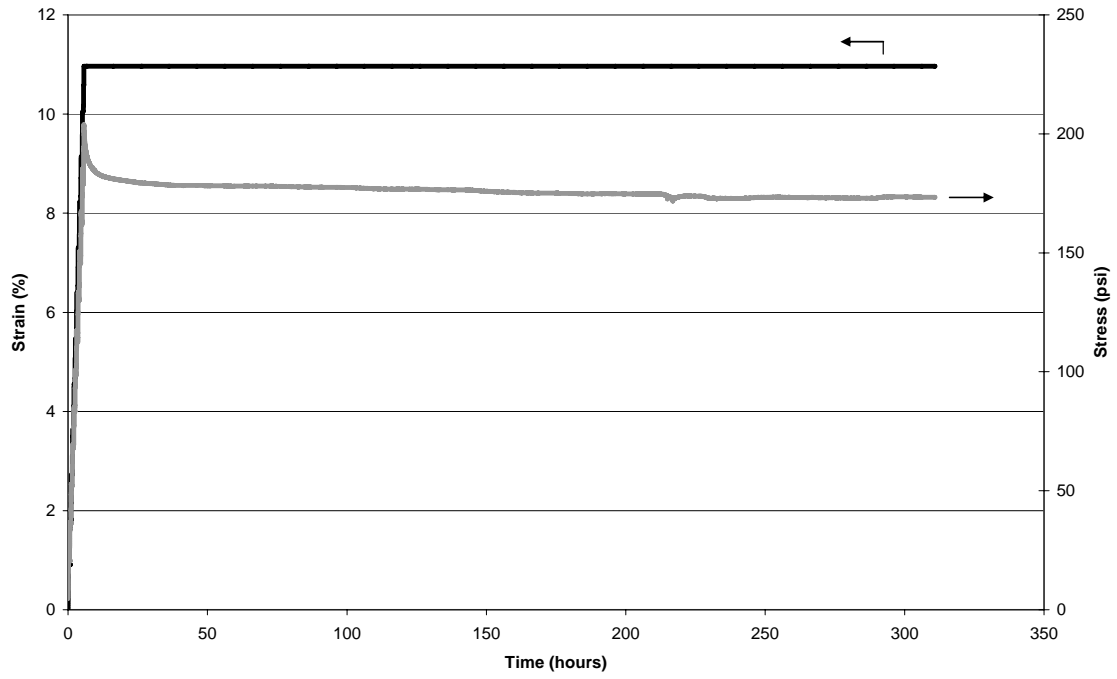

190°C, 200 psi

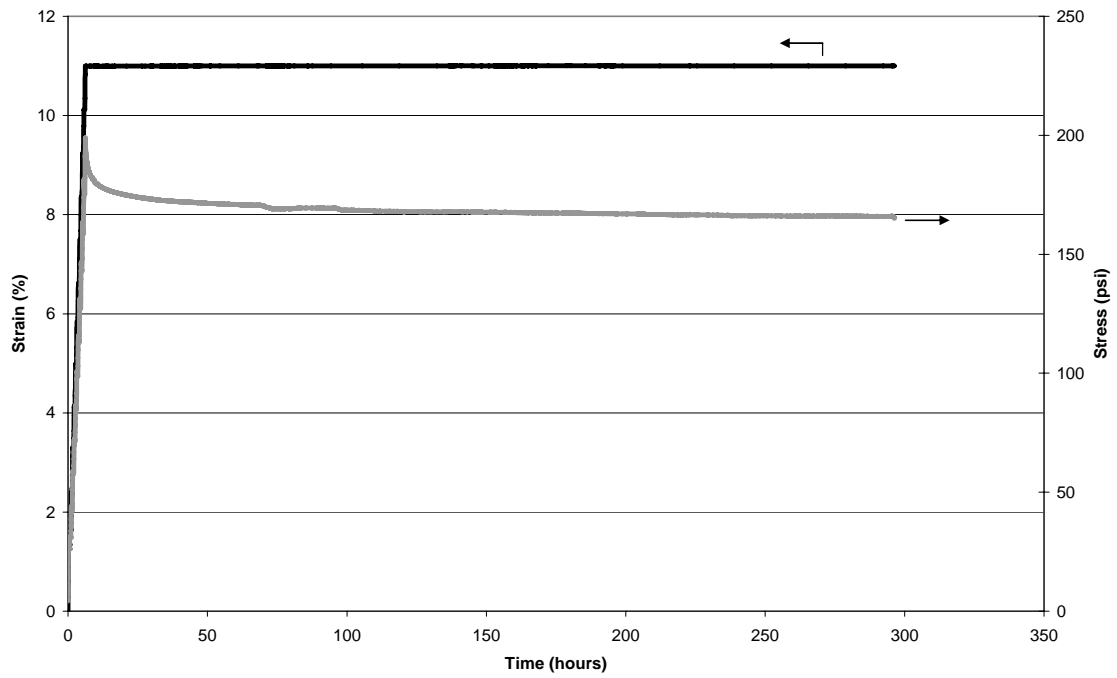

850°C, 100 psi

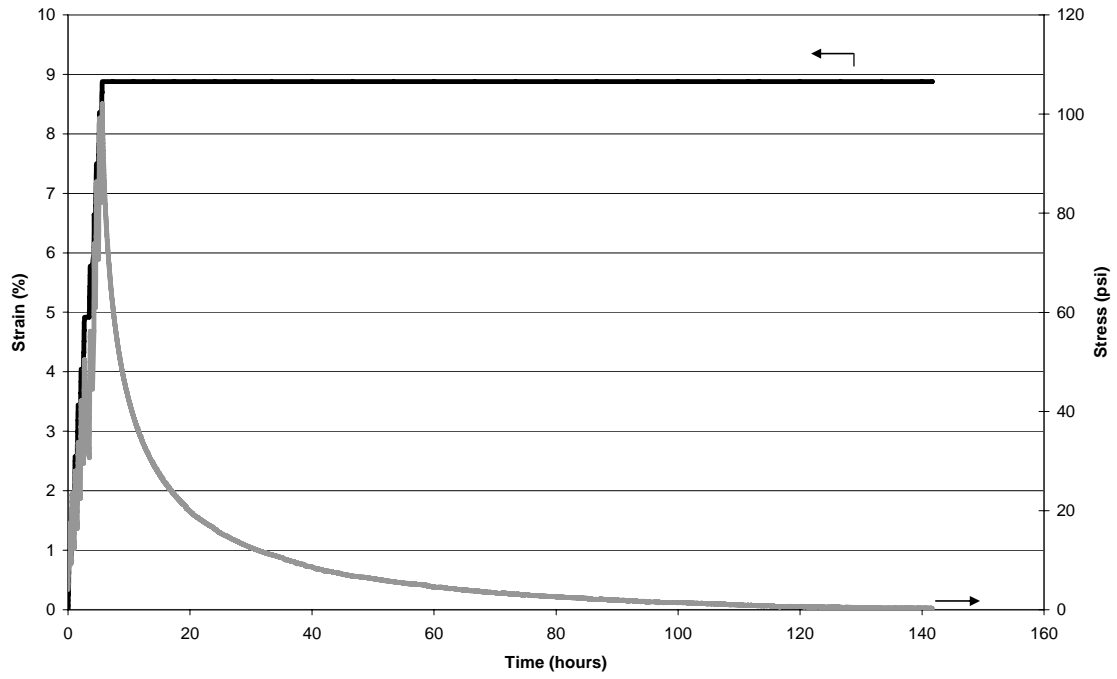

850°C, 100 psi

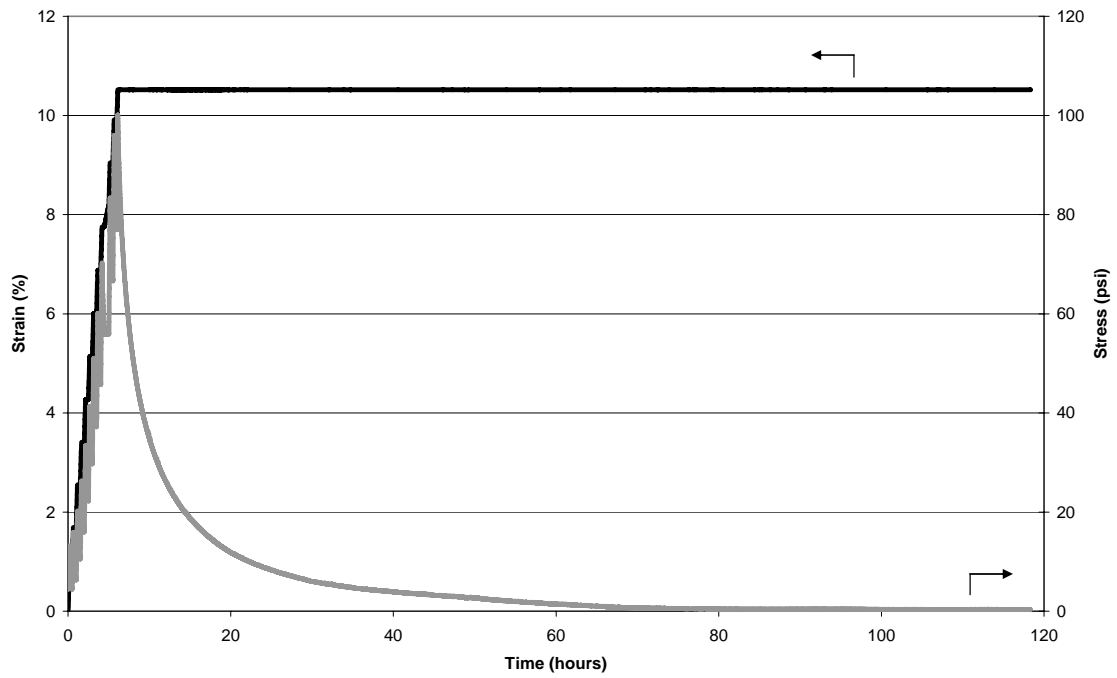

813°C, 100 psi

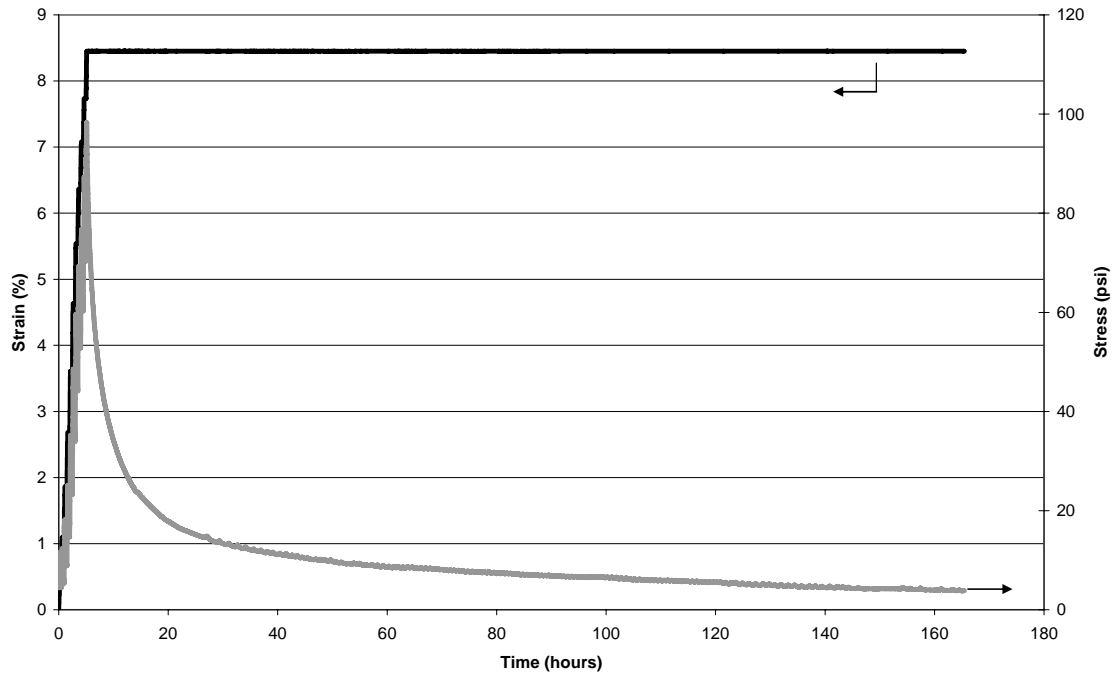

813°C, 100 psi

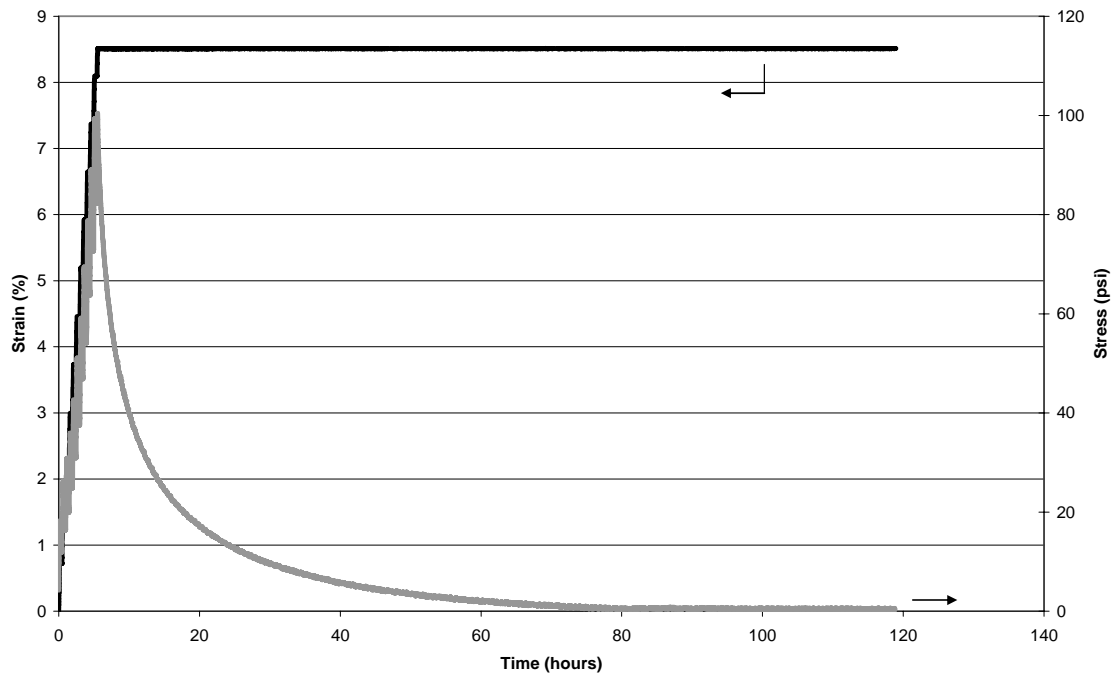

382°C, 100 psi

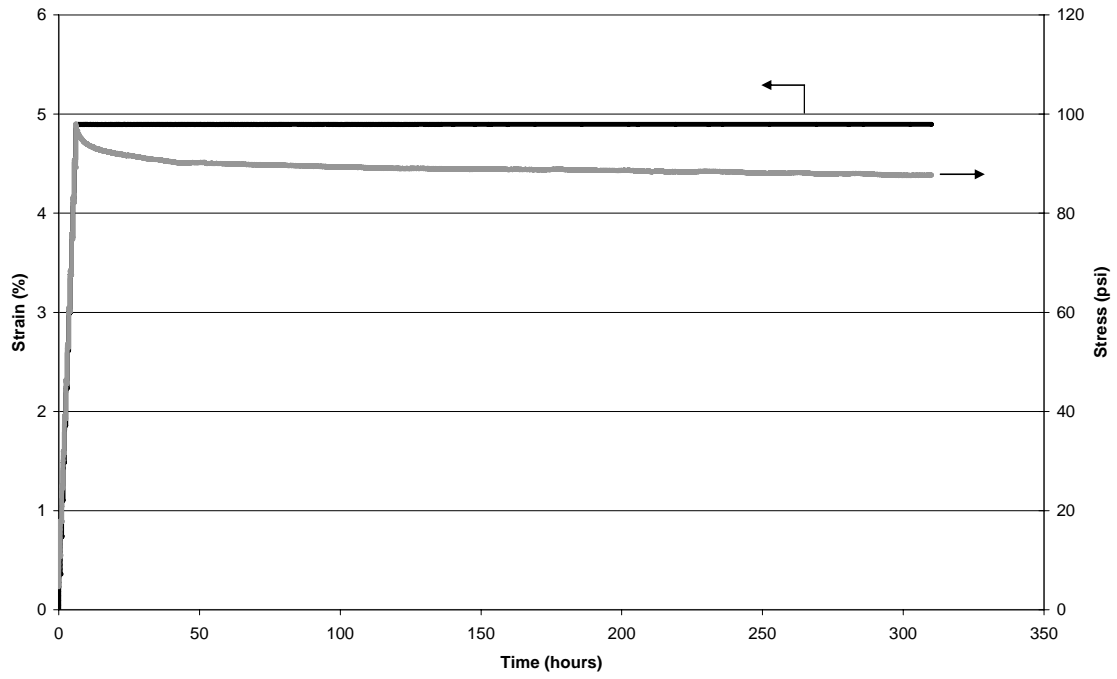

382°C, 100 psi

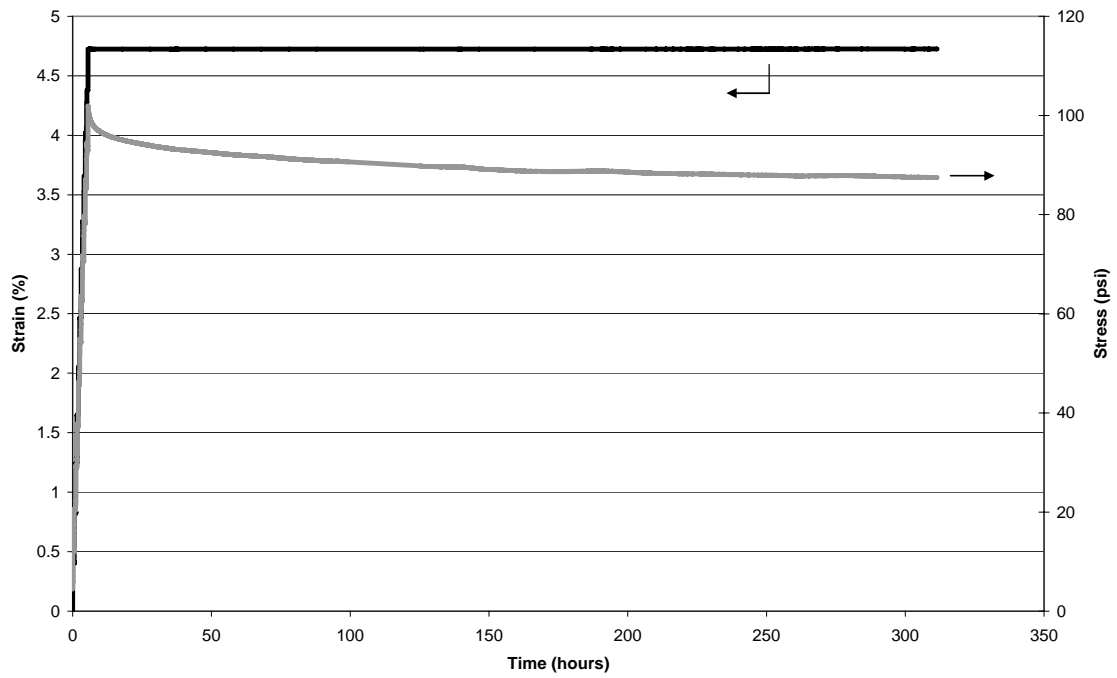



190°C, 100 psi

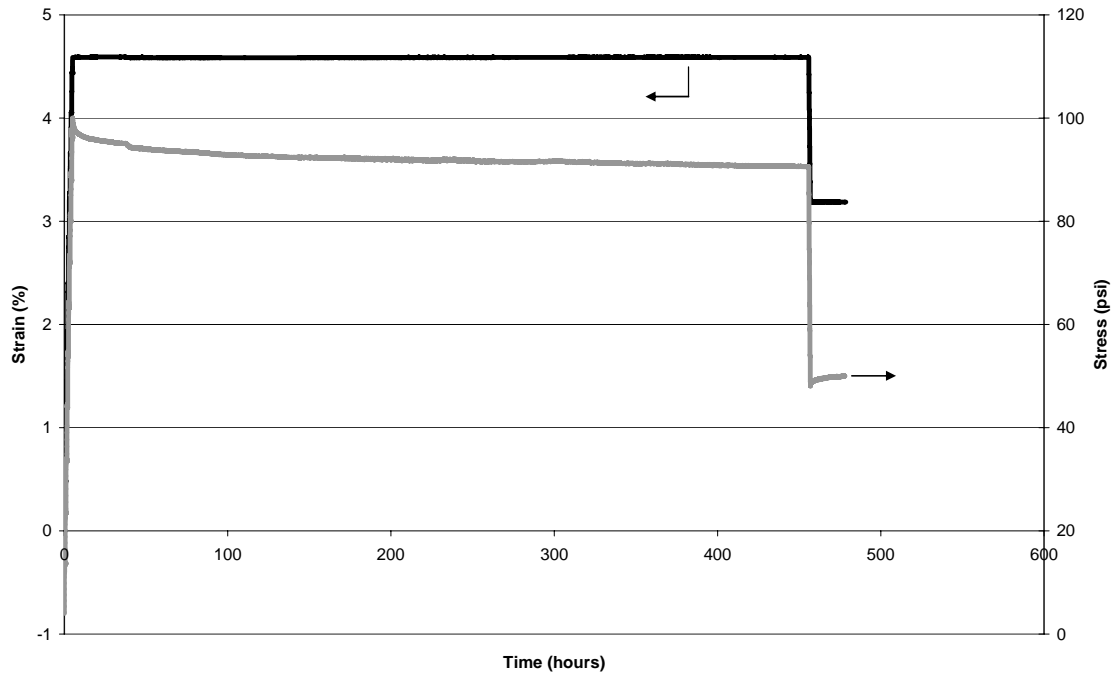

190°C, 100 psi

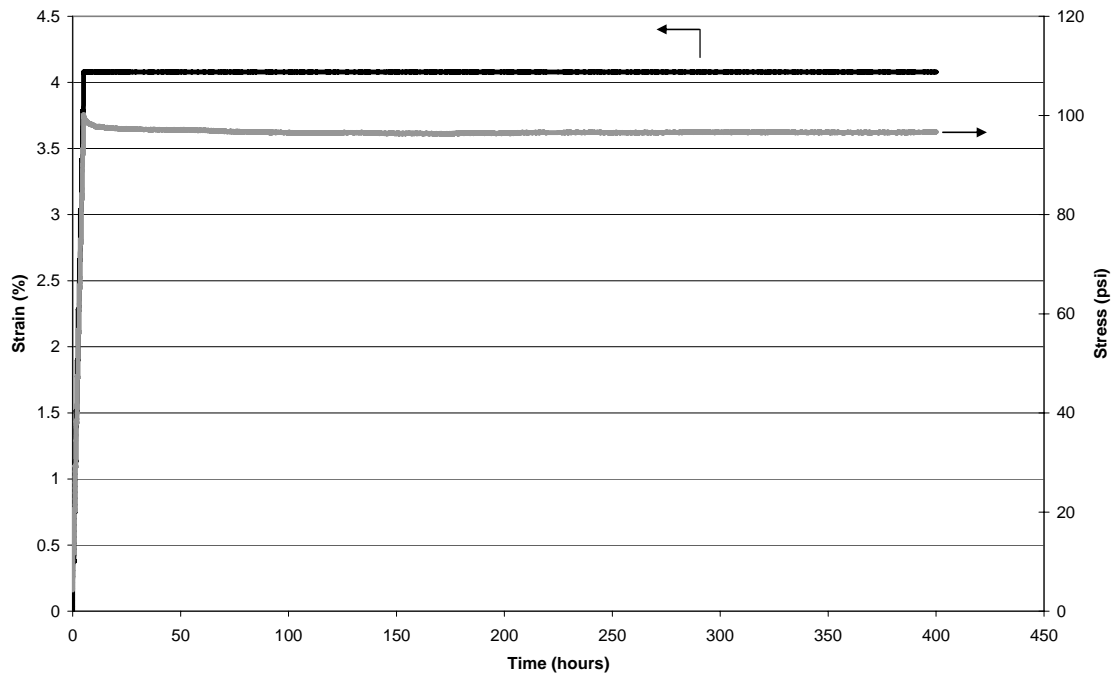



Appendix 3

Min-K Sample Densities with Respect to Batch Designations and Test Numbers

<b>Test</b>	<b>Batch</b>	<b>Density (g/in.<sup>3</sup>)</b>
<b>Isothermal</b>		
Test #1	Batch #1	5.42
Test #2	Batch #1	5.06
Test #3	Batch #1	5.29
Test #4	Batch #1	5.46
Test #5	Batch #1	5.36
Test #6	Batch #1	5.23
Test #7	Batch #1	5.14
Test #8	Batch #1	5.14
Test #9	Batch #1	5.19
Test #10	Batch #1	5.21
Test #11	Batch #1	5.19
Test #12	Batch #1	5.09
Test #13	Batch #1	5.23
Test #14	Batch #1	5.31
Test #15	Batch #1	5.31
Test #16	Batch #1	5.45
Test #17	Batch #1	5.42
Test #18	Batch #2	5.20
Test #19	Batch #1	5.19
Test #20	Batch #2	5.24
<b>Gradient</b>		
Test #2	Batch #1	-
Test #3	Batch #1	5.12
Test #4	Batch #1	4.98
Test #6	Batch #1	5.01
Test #7	Batch #2	5.45
Test #8	Batch #2	5.45
Test #9	Batch #2	5.36
Test #10	Batch #3	5.46
Test #11	Batch #4	5.34
Test #13	Batch #4	5.21
Test #15	Batch #3	5.37



**INTERNAL DISTRIBUTION**

1. J.G. Hemrick
2. J.F. King
3. E. Lara-Curzio
4. George Ulrich
5. Suzanne Wilson
6. ORNL Technical Information Office (RC)

**EXTERNAL DISTRIBUTION**

7. Russell Bennett, Teledyne Energy Systems, 10707 Gilroy Road, Hunt Valley, MD 21031
8. Bob Carpenter, Orbital Sciences Corporation, 20030 Century Blvd., Suite 102, Germantown, MD 20874
9. John Dowicki, Office of Radioisotope Power Systems, NE-34/GTN, U.S. Department of Energy, 1000 Independence Avenue SW, Washington, DC 29585-1290
10. Lloyd Edgerly, Office of Radioisotope Power Systems, NE-34/GTN, U.S. Department of Energy, 1000 Independence Avenue SW, Washington, DC 29585-1290
11. Michael Lauer, United Technologies, 6633 Canoga Avenue, Canoga Park, CA 91309
12. Alfred Lewis, United Technologies, 6633 Canoga Avenue, Canoga Park, CA 91309
13. Kelly Lively, Idaho National Laboratory, P.O. Box 1625, Idaho Falls, ID 83415
14. Nora Low, United Technologies, 6633 Canoga Avenue, Canoga Park, CA 91309
15. Mike McKittrick, Teledyne Energy Systems, 10707 Gilroy Road, Hunt Valley, MD 21031
16. Office of Scientific and Technical Information (PDF file to ORNL Releasing Official, D.R. Hamrin)
17. Art Rabeau, Orbital Sciences Corporation, 20030 Century Blvd., Suite 102, Germantown, MD 20874
18. Emil Skrabek, Orbital Sciences Corporation, 20030 Century Blvd., Suite 102, Germantown, MD 20874
19. Scott Vogt, United Technologies, 6633 Canoga Avenue, Canoga Park, CA 91309
20. Bob Wiley, Office of Radioisotope Power Systems, NE-34/GTN, U.S. Department of Energy, 1000 Independence Avenue SW, Washington, DC 29585-1290